



Operating Manual CMGZ309.EIP

PID Closed Loop Tension Controller
with EtherNet/IP Interface

Version	2.26	09/2020	NS
Firmware Version	V2.25		



EtherNet/IP™

Diese Bedienungsanleitung ist auch in Deutsch erhältlich.
Bitte kontaktieren Sie Ihren nächstgelegenen FMS Vertreter.

Table of Contents

1	Safety Instructions.....	5
1.1	Description Conditions	5
1.2	List of Safety Instructions	6
2	System Description.....	7
2.1	Tension Controller CMGZ309 and its Subunits	7
2.2	System Description CMGZ309.EIP	8
2.3	CMG309 Sub Types	9
2.4	Controlling Applications	10
2.5	Controlling a Brake or 4-Quadrant Motor Drive	10
3	Quick Installation Guide.....	11
3.1	Preparations for Setup	11
3.2	Installation / Setup Procedure	11
4	Installation and Wiring.....	12
4.1	Mounting the Force Measuring Roller	12
4.2	Mounting the CMGZ309	12
4.3	Using a Brake Amplifier or the Drive Unit	12
4.4	Wiring the Control Loop	13
4.5	Screw Terminal Arrangement	14
4.6	Connection of the Cable Shield	15
4.7	Digital Inputs	16
4.8	Relays Outputs	17
5	Configuring the System.....	18
5.1	Description of the Operating Panel	18
5.2	Preparations for System Configuration	19
5.3	Offset Compensation	20
5.4	Calibration Methods	20
5.5	Calibration Procedure:	21
6	Network Connection over EtherNet/IP	22
6.1	Ethernet/IP Specification:	22
6.2	Controller Functionality over EtherNet/IP	22
6.3	Integration of CMGZ309.EIP in an Ethernet Network	22
6.4	Configuration of the Controller over EtherNet/IP	23
6.5	Calibration over EtherNet/IP	23
7	Integration in an Allen-Bradley PLC	24
7.1	Hardware Environment	24
7.2	IP Configuration	24
7.3	Integration in a Project	24
7.4	Access to the Tension Values	27
8	Operation.....	29
8.1	Operating the CMGZ309 over the Front Panel	29
8.2	Display Value Selection State	30
8.3	Setting the Reference Value	31
9	Parameter Setting over the Front Panel	32
9.1	Basic Instructions for Parameter Setting	32

9.2	PID Parameter Group	33
9.3	Description of PID Parameters	33
9.4	Function Parameter Group	34
9.5	Configuration Parameter Group	36
9.6	Description of Configuration Parameters	36
9.7	Amplifier Parameter Group	41
9.8	Description of Amplifier Parameters	41
9.9	Adjustment Procedures	43
9.10	Description of Adjustment Procedures	43
9.11	Input / Output Parameter Group	44
9.12	Description of Input / Output Parameters	44
9.13	System Parameter Group	48
9.14	Description System Parameters	48
9.15	Service Parameter Group	51
9.16	Description of Service Parameters	51
9.17	Reset to Default Parameters	53
9.18	Complete Parameter List	54
10	Determination of the Control Parameters	60
10.1	Experimental Determination of the Control Parameters (recommended)	60
10.2	Mathematic Determination of the Control Parameters	60
10.3	Switching the Control Parameters	61
10.4	Manual Operation	62
10.5	Automatic Operation	62
10.6	Additional Settings	64
11	Setup of an Unwind Brake Controller	65
11.1	Configuring the Basic Parameters	65
11.2	Entering the Holding Torque	65
11.3	Enter Start Limit	66
11.4	Enter the Start Time	66
11.5	Enter Brake Time	66
11.6	Enter Brake Booster	66
11.7	Setup of Pilot Control	67
12	Setup of an Unwind Drive Controller.....	69
12.1	Configuring the Basic Parameters	69
12.2	Automatic Start Function for a Unwind Drive Configuration	69
12.3	Pilot Control in an Unwind Drive Configuration	69
13	Setup of a Rewind Drive Controller.....	70
13.1	Configuring the Basic Parameters	70
13.2	Automatic Start Function for a Rewind Drive Configuration	70
13.3	Setup of Pilot Control for a Rewind Drive Configuration	70
13.4	Diameter Adjustment	70
13.5	Taper Function	71
14	Setup of a Line Drive Controller	72
14.1	Configuring the Basic Parameters	72
14.2	Setup of Line Speed Overlay	72
15	Parameter Setting via a PC	73
15.1	Parametrisation via a Web Interface	74
15.2	Parameterization via a PC (peer-to-peer connection)	79



- 16 Dimensions..... 82**
- 17 Trouble Shooting..... 84**
 - 17.1 General Trouble Shooting 84
 - 17.2 Unwind Brake Trouble Shooting 85
 - 17.3 Unwind and Rewind Drive Trouble Shooting 85
 - 17.4 Line Drive Trouble Shooting 86
- 18 Technical Specification 87**
 - 18.1 Technical Data 87
 - 18.2 Input / Output Configuration 87

1 Safety Instructions

All safety related regulations, local codes and instructions that appear in the manual or on equipment must be observed to ensure personal safety and to prevent damage to the equipment connected to it. If equipment is used in a manner not specified by the manufacturer, the protection provided by the equipment may be impaired.

Do not stress the equipment over the specification limits neither during assembly nor operation. To do so can be potentially harmful to persons or equipment in the event of a fault to the equipment.

1.1 Description Conditions

a) Danger of health injury or loss of life



Danger

This symbol refers to high risk for persons to get health injury or loss life. It has to be followed strictly.

b) Risk of damage of machines



Caution

This symbol refers to information, that, if ignored, could cause heavy mechanical damage. This warning has to be followed absolutely.

c) Note for proper function







Note

This symbol refers to an important information about proper use. If not followed, malfunction can be the result.

1.2 List of Safety Instructions



The CMGZ309 controller does not contain a standardised Emergency-stop-concept since such a concept depends heavily on the machine type and application the controller will be used. However the controller can drive brakes with high kinetic energy and drive units with high performance. Depending on the kind of possible malfunctions, full braking or complete release may cause heavy damage of man and/or machine. The machine designer is responsible for system design and for establishing a security concept that is providing appropriate emergency procedures for the possible malfunctions. Auxiliary functions in the CMGZ309 controller support the design of such a security concept.

-  Proper function of the FMS tension controllers is only guaranteed with the recommended application of the components. In case of other arrangement, heavy malfunction can be the result. Therefore, the installation instructions on the following pages must be followed strictly.**
-  Local installation regulations are to preserve safety of electric equipment. They are not taken into consideration by this operating manual. However, they have to be followed strictly.**
-  Bad earth connection may cause electric shock to persons, malfunction of the total system or damage of the control unit. It is vital to ensure a proper earth ground connection.**
-  The processor board is mounted directly behind the operation panel. Improper handling of the electronic boards may cause damage to the fragile equipment. Don't use rough tools such as screwdrivers or pliers! Operators handling the electronic boards must wear a well earthed bracelet in order to discharge static electricity.**
-  If the controller is disabled while the material is running, the drive unit will stop immediately. This might cause material cracks. Therefore, the controller should be disabled only if the machine is no longer running.**

2 System Description

2.1 Tension Controller CMGZ309 and its Subunits

The FMS CMGZ309 is a microprocessor based PID-controller designed for precise closed loop tension control of a running web. It offers selectable control of unwind brake or drive, intermediate drive, or rewinding drive.

There are three possibilities of configuring the CMGZ309.EIP:

- As a plug & play unit via the user friendly control panel and LCD display.
- Via a Web Interface (e.g. web browser Internet Explorer 7 or Firefox 3.5 or higher).
- Via EtherNet/IP interface.

All parameters are stored in a non-volatile EEPROM memory.

Automatic offset compensation, digital signal filtering, automatic start-up ramping function along with a lot of other features creates a very powerful tension control system. The fundamental characteristics of the CMGZ309 remain its operation simplicity and reliability even under challenging operating conditions.

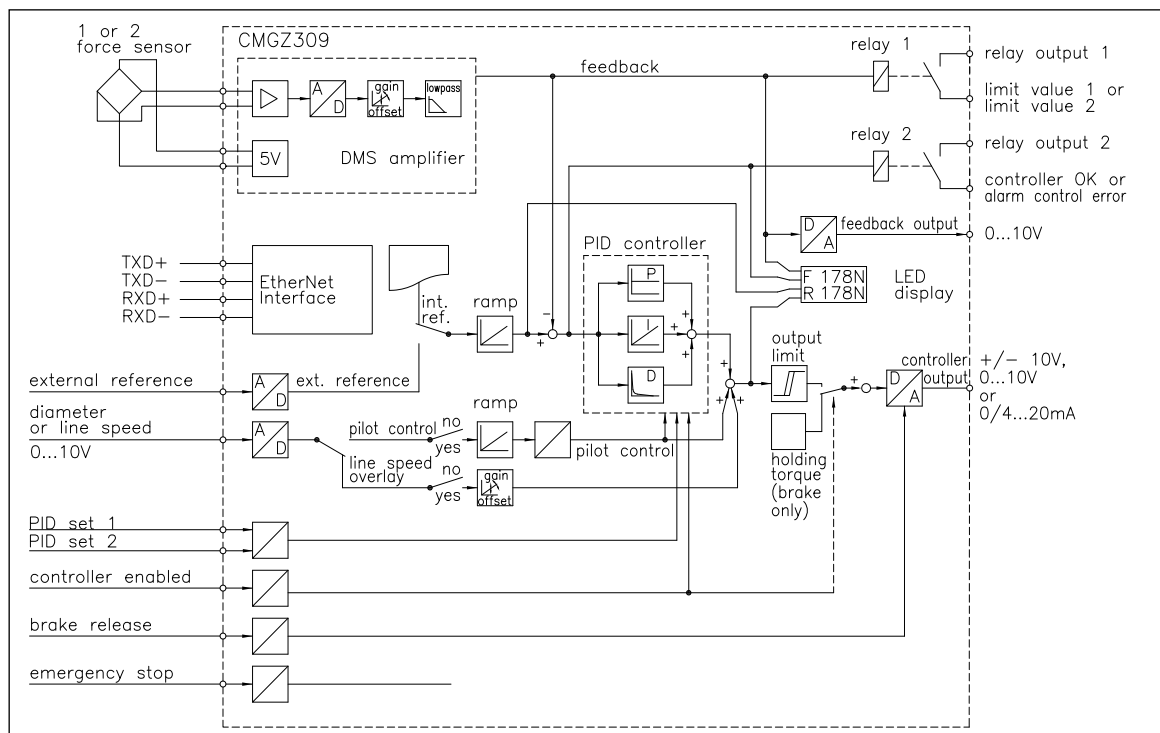

Fig. 1: Block diagram CMGZ309

C309005e

Strain gauge amplifier

The build-in strain gauge amplifier delivers a highly accurate supply voltage (5VDC,) for 1 or 2 force sensors. The force sensors can be wired for a 4-wire circuitry. A highly accurate differential amplifier raises the mV sensor signal up to 10V. This signal will be fed to the A/D converter. The microprocessor does then all application specific calculations such as offset, gain, low-pass filter, limit switches, etc.

PID Controller

The comparator unit compares the reference value with the measured feedback value and transmits the error to the PID controller. The PID controller calculates the output signal according to the difference. The output signal can be 0...10V, $\pm 10V$, 0...20mA or 4...20mA, depending on the configuration.

With a diameter sensor or other source, a 0...10V signal proportional to the actual reel diameter can be fed to the controller. For winder applications, the controller calculates the pilot control resulting from this signal and the actual output value. The PID values are adjusted dynamically according to the changing reel diameter. With a tachometer generator or other source, a 0...10V signal proportional to the line speed can be fed to the controller. Driving a line drive, the controller takes the line speed signal as a base to which the PID signal is overlaid. Thus the controller is considerably unloaded and must only control the deviation to the line speed.

2.2 System Description CMGZ309.EIP

The controller version CMGZ309.EIP offers a built-in Ethernet/IP field bus for the use in a respective network. EtherNet/IP bases on the Ethernet TCP/IP and UDP using CIP (Common Industrial Protocol). This allows operation in a standard Ethernet environment. The EIP-interface offers data transfer with cycle times down to 2ms capable of covering fast applications in automated manufacturing processes. The controller is designed to capture and control the material tension. Tension, output values and other process relevant parameters are transmitted over Ethernet to a higher-level control unit or central machine control.

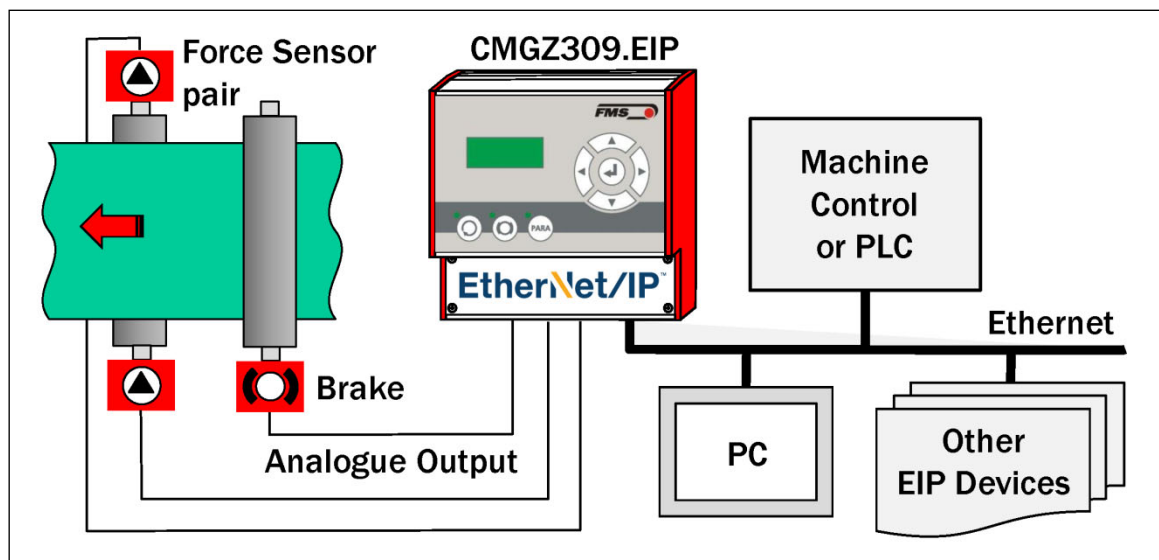

Fig. 2: System Configuration CMGZ309.EIP integrated in Ethernet network C309036e



Note

The EtherNet/IP interface is used in the CMGZ309.EIP for configuration of the device and transmission of production relevant parameters over Ethernet (e.g. Reference, Feedback value, Alarm control error etc.) Furthermore controller status information can be exchanged with and displayed on the machine control panel allowing a remote control of the device. The control loop is usually realized via the analogue outputs (see Fig. 3) but in principle it is also possible to control over the EtherNet/IP field bus.

2.3 CMG309 Sub Types

The tension controller series CMGZ309 is available in two versions:

- CMGZ309 with standard analogue outputs
- CMGZ309.EIP with analogue outputs and integrated EtherNet/IP interface

Both versions are available in different housing / mounting options:

CMGZ309.R / .S / .W

Description of the four different housing options:

- CMGZ309.R: Rail mount housing
- CMGZ309.S: Panel mount housing
- CMGZ309.W: Wall mount housing

2.4 Controlling Applications

The CMGZ309 is a versatile tension controller. Whether unwind brake, unwind drive, intermediate drive, or rewinding drive the controller can be configured to handle effectively the controlling tasks. **Fig. 3:** shows the most common controlling applications:

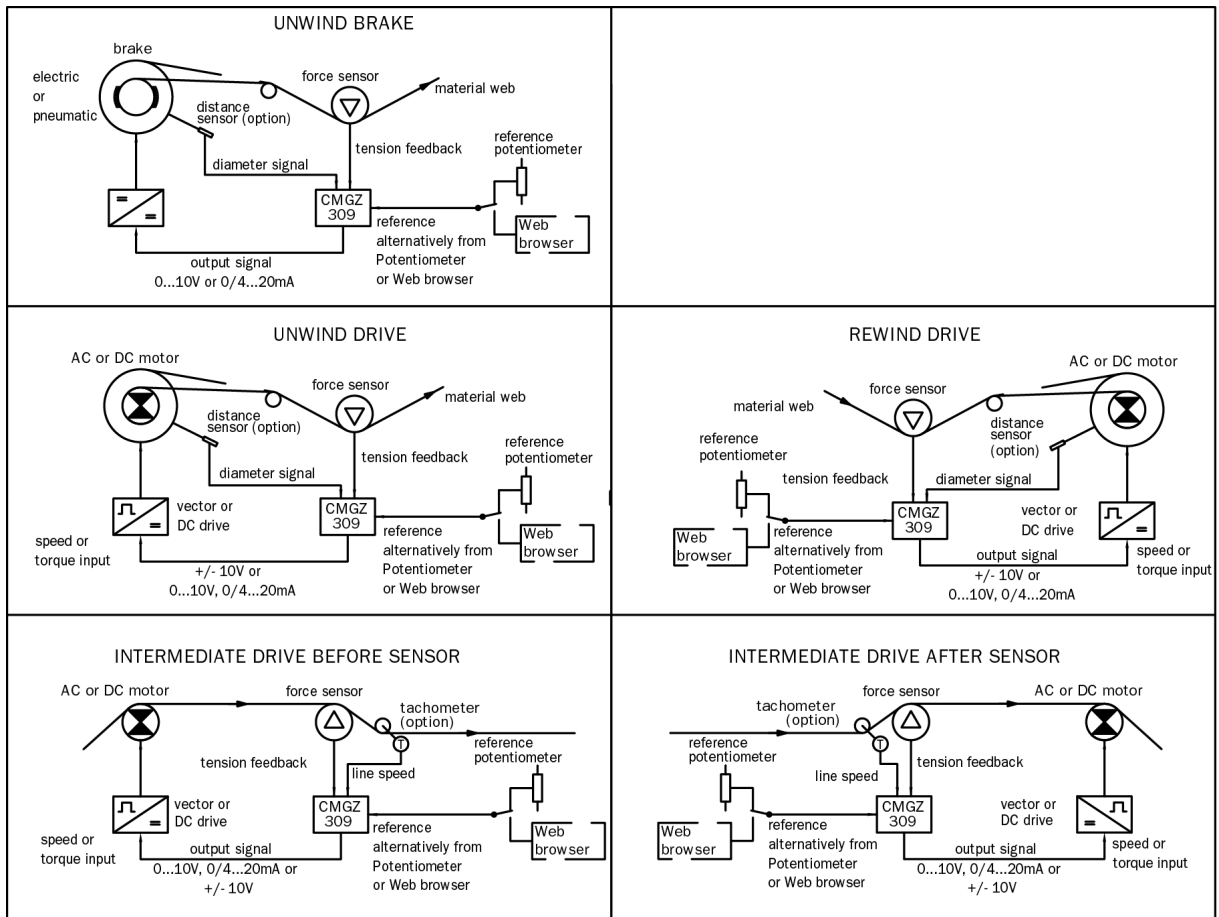

Fig. 3: Schematics of CMGZ309 applications

CMGZ309_BA_Manual.ai

2.5 Controlling a Brake or 4-Quadrant Motor Drive

The CMGZ309 drives the brake corresponding to the output signal of the controller. Any electrical or pneumatic brakes can be used.

AC or DC 4-quadrant drives that are suited to the dynamic requirements and to the motor can be used.

3 Quick Installation Guide

The set-up of the CMGZ309 controller implies mounting the devices on an easily accessible place, wiring, configuring and powering up the system.

3.1 Preparations for Setup

1. Prepare your machine or machine control panel to integrate the CMGZ309 tension controller. Its mounting depends on the chosen housing type. Refer to **Fig. 47 to 50** for the mechanical dimensions and mounting holes of the CMGZ309 type.
2. Check your system requirements such as:
 - Application (unwind brake or drive, rewinding drive etc. (see **Fig.3**))
 - Characteristics of the brake or drive (signal level, max. current, etc.)
 - Operating mode of the analogue input (ext. reference, diameter signal etc.)
 - Controller output configuration w/r to signal level (see **Fig. 1**)
 - Feedback output configuration (signal level)
 - Digital inputs assignment (e.g. PID-parameter set)
 - Configuration of Relay outputs
 - Interfaces (TCP/IP)
 - Unit system (metric, imperial)
 - Emergency stop procedures
3. Draw the wiring diagram for your configuration (see **4.4 “Wiring the Control Loop”**)
4. If required, determine special parameters (ref. to **chapter 9.1 to 9.17**)

3.2 Installation / Setup Procedure

1. Mount your force measuring roller to your machine frame.
2. Mount the CMGZ309 on your machine or on the controll panel.
3. Wire the force measuring sensors to the CMGZ309 (ref. to **4.4 “Wiring the Control Loop”** and **4.5 “Screw terminal Arrangement”**)
4. Make sure the power supply voltage is in the range 18 to 36V DC (Vnom= 24V)
5. Power your system on
6. Perform the offset compensation procedure (ref. to **5.3 “Offset Compensation”**)
7. Perform the calibration procedure (ref. to **5.4 “Calibration”**)
8. Perform a test run with default parameters, low speed and low material tension:
 - Input reference value (ref. to **8.3 “Setting the Reference Value“.**)
 - Enable controller (ref. to **10.5 “Automatic Operation“**)
 - Determine PID control parameters and set machine into operation (ref. to **10.1 “Experimental Determination of the Control Parameters”**)
9. If required, setup pilot control or line speed overlay (ref. to **11.7 “Setup of pilot control“** or **14.2 “Setup of Line Speed Overlay“**).
10. If required, make additional settings and corrections to the PID parameter set (ref. to **chapter 9.2** and **chapter 9.17**)
11. Integration of CMGZ309.EIP in an Ethernet network and PLC (see **6.3** and **7**).

4 Installation and Wiring



Caution

Proper function of the FMS tension controller is only guaranteed with the recommended application of the components. Other arrangements, can cause heavy malfunctions. Therefore, the installation instructions on the following pages must strictly be followed.



Caution

Local installation regulations are to preserve safety of electric equipment. They are not taken into consideration by this operating manual. However, they have to be followed strictly.

4.1 Mounting the Force Measuring Roller

Mounting of the force sensors is done according to the FMS Installation manual which is delivered together with the force sensors.

4.2 Mounting the CMGZ309

The CMGZ309 series is available in four different housing options:

1. Rail mount housing (electrical connections via screw terminals)
2. Panel mount housing
3. Wall mount housing
4. Larger wall mount housing for main supply

The mechanical dimensions can be seen in **chapter 16**.

4.3 Using a Brake Amplifier or the Drive Unit

Brake and brake amplifier respectively drive unit and motor will be mounted according to the manufacturer's guide lines. Due to the wide variety of available types, no further recommendation can be made in this manual. Wiring is done according to the wiring diagram (see **Fig. 4** and **5**).

If an AC drive unit is used, the energy produced in the motor during the braking process must be dissipated on a resistor.

4.4 Wiring the Control Loop

Use the original FMS cables to connect the system components together. The connection between the force sensors and the electronic unit is done with a 2x2x0.25 mm² [AWG 23] cable. The wiring diagrams provide an overview of the signal names and the corresponding cable terminals in the electronic unit. Parallel wiring of the two sensors of a measuring roller is done internally in the processor board.

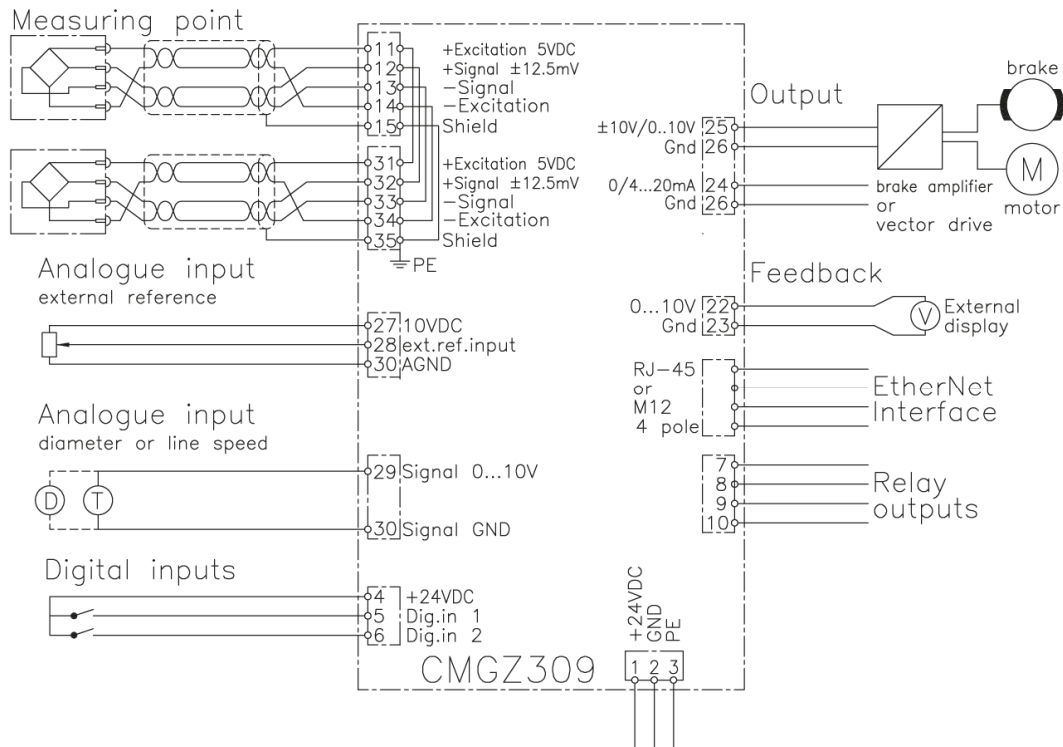

Fig. 4: Wiring diagram CMGZ309

C309006e

4.5 Screw Terminal Arrangement

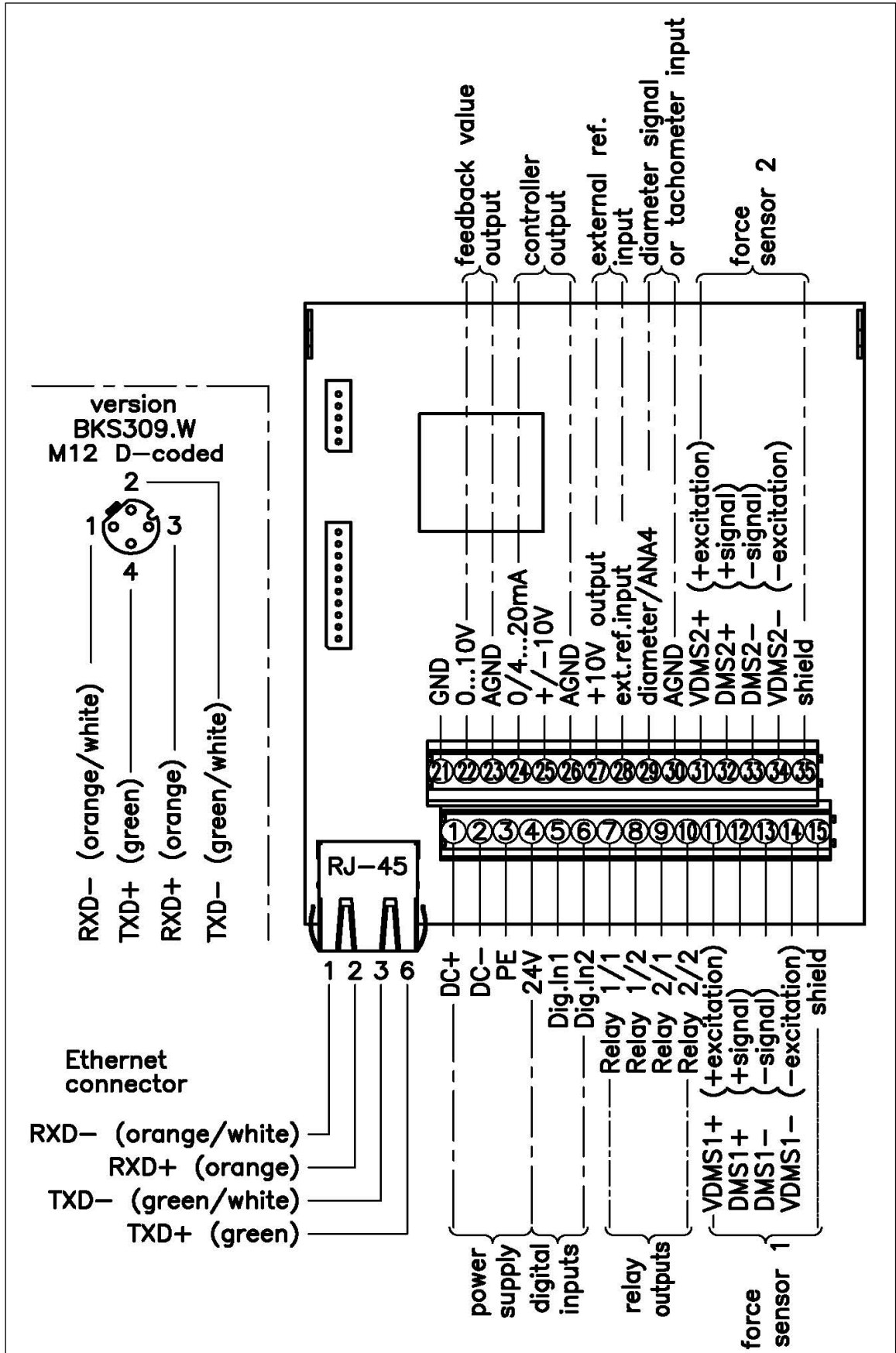

Fig. 5: Screw terminal arrangement on processor board

C309007e



Caution

Bad earth connection may cause electric shock to persons, malfunction of the total system or damage of the control unit. It is vital to ensure that there is a proper and secure earth ground connection.

4.6 Connection of the Cable Shield

Cable shields must be connected as indicated in the wiring diagram (see Fig. 4 and 5). The shield should be connected only to the tension controller side. On the force sensor side, the shield should stay open. Other arrangements may cause ground/earth loops which may interfere with the measuring signal. Malfunction can be the results. If a housing type is used with PG glands, one must pay heed to a proper connection of the shield. Skinning of the cable and shield handling are indicated in Fig. 6.

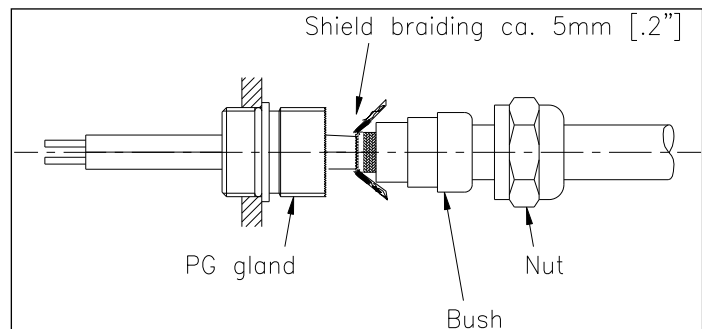

Fig. 6: Shield connection

E470009e



Note

Force sensors deliver a signal of a few mV and are therefore susceptible to external influences. To increase immunity to interfering use one twisted pair cable for +signal and -signal. This signal cables must be separated from power lines.



Note

Connecting the shield of the signal cable to the electronic unit and to the force sensor may cause ground circuits which may interfere with the measuring signal. Malfunction can be the result. The shield should be connected only to the electronic unit. On the „force sensor side“, the shield should stay open.

4.7 Digital Inputs

The CMGZ309 controller provides 2 digital inputs for special functions. The digital inputs are level or edge triggered. Each digital input can be configured individually and can perform an assigned function. The digital inputs are configured in the parameter I/O Parameter Group (see chapter 7.12). Following function can be assigned to each digital input:

- Enable control, level triggered [Levl→Ctr]
- Enable control, edge triggered [Edge→Ctr]
- Disabled [Disabled]
- Select PID parameter set [SelecPID]
- Emergency Stop [EmerStop]
- Brake release, level triggered [Levl→BRe]
- Brake release, edge triggered [Edge→BRe]

Hardware access via screw terminals (see Fig. 4 and 5)

Signal Name	Terminal #
Dig.In 1	5
Dig.In 2	6



Danger

The CMGZ309 controller does not contain a standardised Emergency-stop-concept since such a concept depends heavily on the machine type and application the controller will be used. However the controller can drive brakes with high kinetic energy and drive units with high performance. Depending on the kind of possible malfunctions, full braking or complete release may cause heavy damage of man and/or machine.

The machine designer is responsible for system design and for establishing a security concept that is providing appropriate emergency procedures for the possible malfunctions. Auxiliary functions in the CMGZ309 controller support the design of such a security concept.

Refer to chapter 9.13 “Description of Input / Output Parameter Group” for more details about the functions.

4.8 Relays Outputs

The CMGZ309 provides 2 programmable relay outputs. The outputs are software controlled. Electrically they are potential-free. Each relay can be configured individually. If the defined limit condition are violated the relay output will be activated. The relays are configured in the I/O parameter group (see 9.12).

Following conditions can be checked with each relay output:

- Indicated if limit value 1 [*Limit 1*] has been violated
- Indicated if limit value 2 [*Limit 2*] has been violated
- Indicate if the control error [*CtrError*] has been overshoot
- Indicate if the controller is active [*Ctr ON*]
- Relay output disabled [*Disabled*]

Hardware access via screw terminals (see Fig. 3 and 4)

Signal Name	Terminal #
Relay 1/1	7
Relay 1/2	8
Relay 2/1	9
Relay 2/2	10

For more details about the functions refer to 9.13 “Description Input / Output Parameter Group”.

5 Configuring the System

After having mounted and wired the tension controller on the machine, the system can now be configured to the specific requirements of the application.

5.1 Description of the Operating Panel

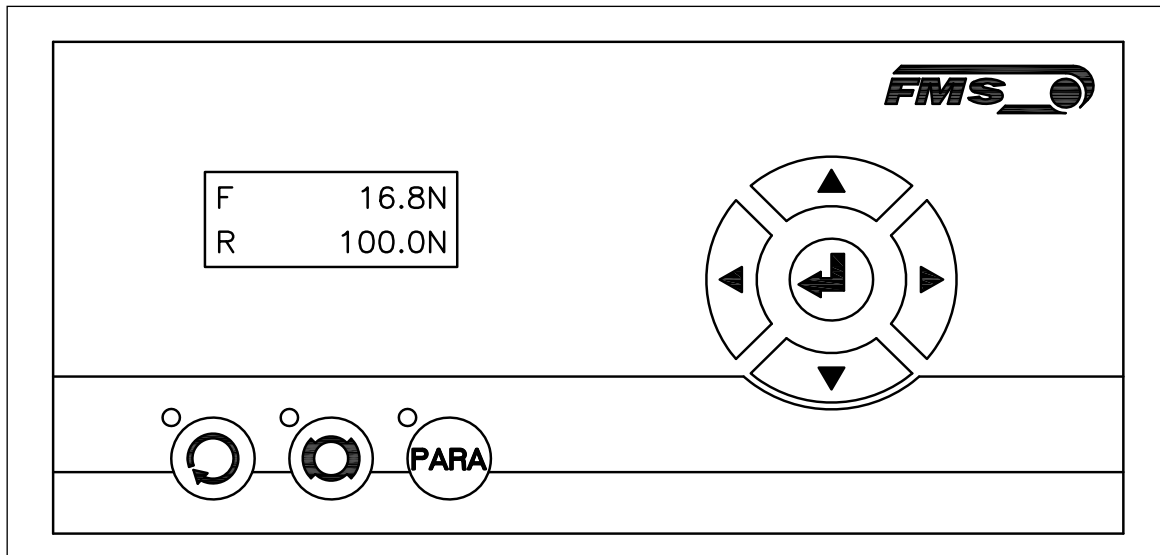

Fig. 7: View of the Operating Panel CMGZ309.W

C309009e

Key	Key function during operation
	Control enable. The LED indicates that this function is active.
	Brake release. The LED indicates that the machine is stopped.
	To enter the Parameter Setting Mode, press the key for longer than 3 sec. The LED will light and the first parameter group will appear on the LCD display. The State Diagrams (Fig. 20 to 29) in chapter 9 "Parameter Setting over the Front Panel" will help you to navigate in the parameter setting mode.
	Enter key
	Changes the parameter selection.
	Increases the parameter values. Pressing the button increases continuously the parameter value.
	Decreases the parameter values. Pressing the button reduces continuously the parameter value.

Fig. 8: Functions of the operation panel keys

5.2 Preparations for System Configuration











In order to facilitate the configuration of the control loop it is advisable to adapt some basic system parameters to the specific requirement of the application.

1. Adopt password
2. Set the language on the display
3. Set measuring unit

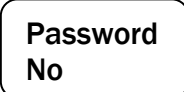
Above features are changed in the **9.14** "System Parameter Group". Refer to **Fig. 28** to visualise the following parameter changing procedures.







A) Adopt Password

The password cannot be changed. It is always **3231**. However, it can be adopted or disabled. If adopted, the system will request the password for every parameter change. If you wish to adopt the password, follow the following instructions:

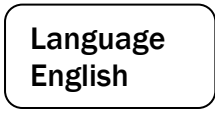
1. Hold the  key for longer than 3 sec. until you enter the Parametrisation State.
2. The display shows . Scroll the menu by pressing the  key until you are in the parameter group "System".
3. Press . The display shows .
4. Press again . The display starts flashing indicating that you can now change the parameter with the   keys.
5. Confirm the change by pressing the Enter key .
6. If you want to change the language, continue with following section **B) Change Language**.
7. Press the  key twice, if you want to return to the Operation State. If you desire to change the language, continue with the steps below.







B) Change Language

The default setting for the language is English..

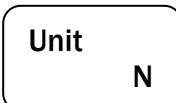
1. Press  to select the Parameter *Language*. Display: .
2. Press again . The display starts flashing indicating that you can now change the parameter with the   keys. Select the desired language
3. Confirm the change by pressing the Enter key .
4. If you want to change the measuring unit, continue with following section **C) Change the Measuring Units**.
5. Press the  key twice, if you want to return to the Operation State. If you desire to change the language, continue with the steps below.





C) Change the Measuring Units

The default tension measuring unit is N (Newton). The user can, however, select another unit before the system is calibrated.

1. Press  to select the Parameter *Unit*. Display: 
2. Press again . The display starts flashing indicating that you can now change the measuring unit with the   keys.
3. Confirm the change by pressing the Enter key .
4. Press the  key twice to return to the Operation State.

5.3 Offset Compensation

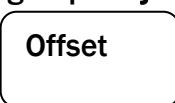
With the Offset Compensation one can compensate the roller weight. It is always performed before the calibration. The Force Measuring roller should not be loaded while the Offset Compensation is carried out. Continue with following steps:

1. Hold the  key for longer than 3 sec. until you enter the Parametrisation State.
2. Scroll the menu with the  key until you are in the parameter group “Adjust”
3. Press  key to select the parameter group “Offset”. Display: 
4. Press again  to start the Offset Compensation. After pressing the key this procedure will be executed automatically. The display will first show “Offset running” and if successfully completed “Offset complete”.

5.4 Calibration Methods

The Calibration procedure sets the Gain of the amplifier. If successfully performed the displayed force on the LCD will correspond to the actual force applied on the material (taking the wrap angle into account). There are two methods of calibrating the system. The first method uses a defined weight. The second method is based on a calculation method in conjunction with the FMS Calculator. The Calculator tool can be downloaded from the FMS web page. FMS recommends using the method with the weight (see Fig. 9) since it delivers the most accurate results.

To set the Gain, load a rope with a defined weight on the roller. The roller configuration must correspond to the real configuration in the machine (wrap angle, distance of the rollers etc.).

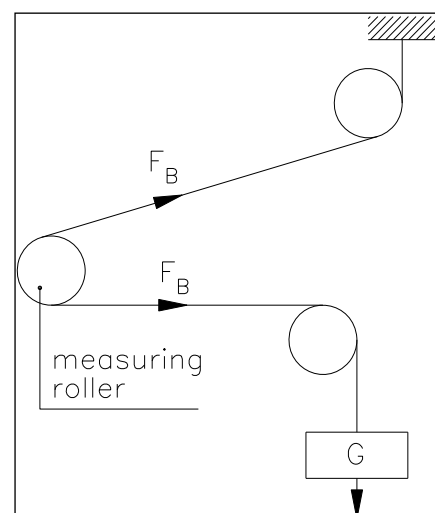





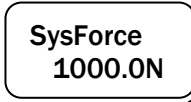



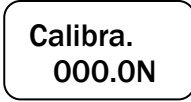



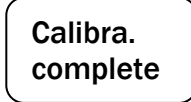



Fig. 9: Calibrating the amplifier C431011e

5.5 Calibration Procedure:

Refer to **Fig. 10** and **Fig. 25** “State Diagram Adjustment Procedures”.

1. Hold the  key for longer than 3 sec. until you enter the Parametrisation State.
2. Scroll the menu with the  key until you are in the parameter group “Adjust”
3. Press  to enter the Parameter Selection Mode.
4. Scroll the menu with the  key until the parameter “Calibration” is displayed.
5. Press again  to start the calibration procedure. The display shows “with “SysForce” flashing. 
6. Enter the force you have installed in your measuring roller with   keys. E.g. if you have a roller with two 250N sensors, enter the system force 500N.
7. Confirm the input with .
8. The display will now show  with “Calibra.” flashing.
9. Enter here the force corresponding to your weight with   keys.
10. Confirm your input with .
11. The controller will confirm a successful calibration with  and jump back to the parameter *Calibration*.
12. Press the  key twice to return to the Operation State.

6 Network Connection over EtherNet/IP

The controller CMGZ309.EIP is able to communicate with other devices over an Ethernet network. CIP (Common Industrial Protocol) is used as the protocol for the data link. The controller acts as a so called “Producer” and the machine control (or PLC) as the “Consumer”.

6.1 Ethernet/IP Specification:

Physical layer: Ethernet IEEE 802.3.

Transport protocol: TCP/IP und UDP

Standard: CIP IEC 61158

Conformity: CPF 2 (Communication Profile Family 2) IEC 61784-1

6.2 Controller Functionality over EtherNet/IP

Basically all functions for configuration and calibration can be performed over EtherNet/IP. Furthermore, production relevant parameters or controller status information can be made available to the Consumer (PLC).

6.3 Integration of CMGZ309.EIP in an Ethernet Network

In order to integrate the controller in an Ethernet network and enable data transfer over it following conditions must be fulfilled:

- ✓ A CMGZ309 controller with the option EtherNet/IP (EIP) must be used.
- ✓ The IP-Address must be assigned in the fix address block and must be unambiguously. It may only exist once in the network.
- ✓ The network mask must correspond with the used device configuration.

If these prerequisites are given, the consumer (PLC) will recognise the controller as an EtherNet/IP device in the network and be able to communicate with it. The interface information for CMGZ309.EIP is defined in an EDS-file. The EDS file is only used as documentation and cannot be imported into RSLogix 5000.

EDS-files for CMGZ309. EIP can be downloaded from the FMS webpage.



Note

The device does not support the import of the EDS files. The import with development software e.g. RSLogix5000 will generate error messages.

Utilize “Messages” to change parameter values of the device. Details are explained in the sample file which is available for download on the FMS website.

6.4 Configuration of the Controller over EtherNet/IP

CMGZ309.EIP may, but need not be configured via EtherNet/IP. The device can be configured by means of a higher-level controller, PLC or any other machine control unit. They are all integrated in the same network. The communication between machine control and controller is carried out with dedicated software (e.g. RSLogix5000 from Rockwell). Please refer to the operating manual of the respective higher-level controller.

There are three possibilities of configuring the CMGZ309.EIP. If the method over EtherNet/IP is used, the other two options (operation panel or web interface) are still possible but not meaningful. The EtherNet/IP method has then always priority and overwrites any other configurations set by the other two methods. If the configuration over EtherNet/IP is selected then messages from the PLC to the EMGZ309 must be used.

How the messages are used is described in the example project.

The example project CMGZ309_EIP_Example_Project_Vx.xx is available for download on the FMS website.



Note

The configuration of the controller via EtherNet/IP must be used as commissioning procedure. Continuously writing parameters on a cyclic base is not allowed and can will lead to communication problems and reduced the lifetime of the device. Furthermore, the lifetime of the flash memory will dramatically be reduced.

6.5 Calibration over EtherNet/IP

Usually the calibration procedure for CMGZ309.EIP is carried out at the commissioning of the machine. The two commands **Offset** and **Calibration** are available for the calibration of the controller over EtherNet/IP. From case to case it is to consider whether a calibration via web interface or operation panel is more favourable. With difficult accessibility of the controller it might make sense to do the calibration over EtherNet/IP.

7 Integration in an Allen-Bradley PLC

Following chapters deal with the integration and operation of the CMGZ309.EIP with a higher-level Allen-Bradley PLC. The project software RSLogix5000 from Allen-Bradley is required to program the PLC. Furthermore, it is assumed that a development system with PC and corresponding development software RSLogix from Rockwell Automation is available and the programmer is familiar with these tools..

7.1 Hardware Environment

The CMGZ309.EIP must be connected to an Ethernet switch which in turn is in the same network as the PLC. Only in this way a communication between CMGZ309.EIP and PLC can take place. Several CMGZ309.EIP or other EtherNet/IP devices can be connected to the same network.

7.2 IP Configuration

In an industrial environment the IP addresses are normally assigned fix to the EIP devices. This holds also for the CMGZ309.EIP controller that needs a fix IP address in the network. The IP address configuration must take place before the controller is integrated in a network. This is done over the operation panel or over the web interface. The procedures are described in the state diagrams **chapters 9.14 “System Parameter Group” (Fig. 28)** and **chapter 15.1 (Fig.45)**

7.3 Integration in a Project

Before starting the development system RSLogix5000 on the PLC, the controller need to be connected to the network and powered-up. Now a new project or an existing project can be opened in RSLogix5000. Search in the tree structure *Controller Organizer* for the listing **Ethernet** and make a right mouse click (see **Fig. 11**).

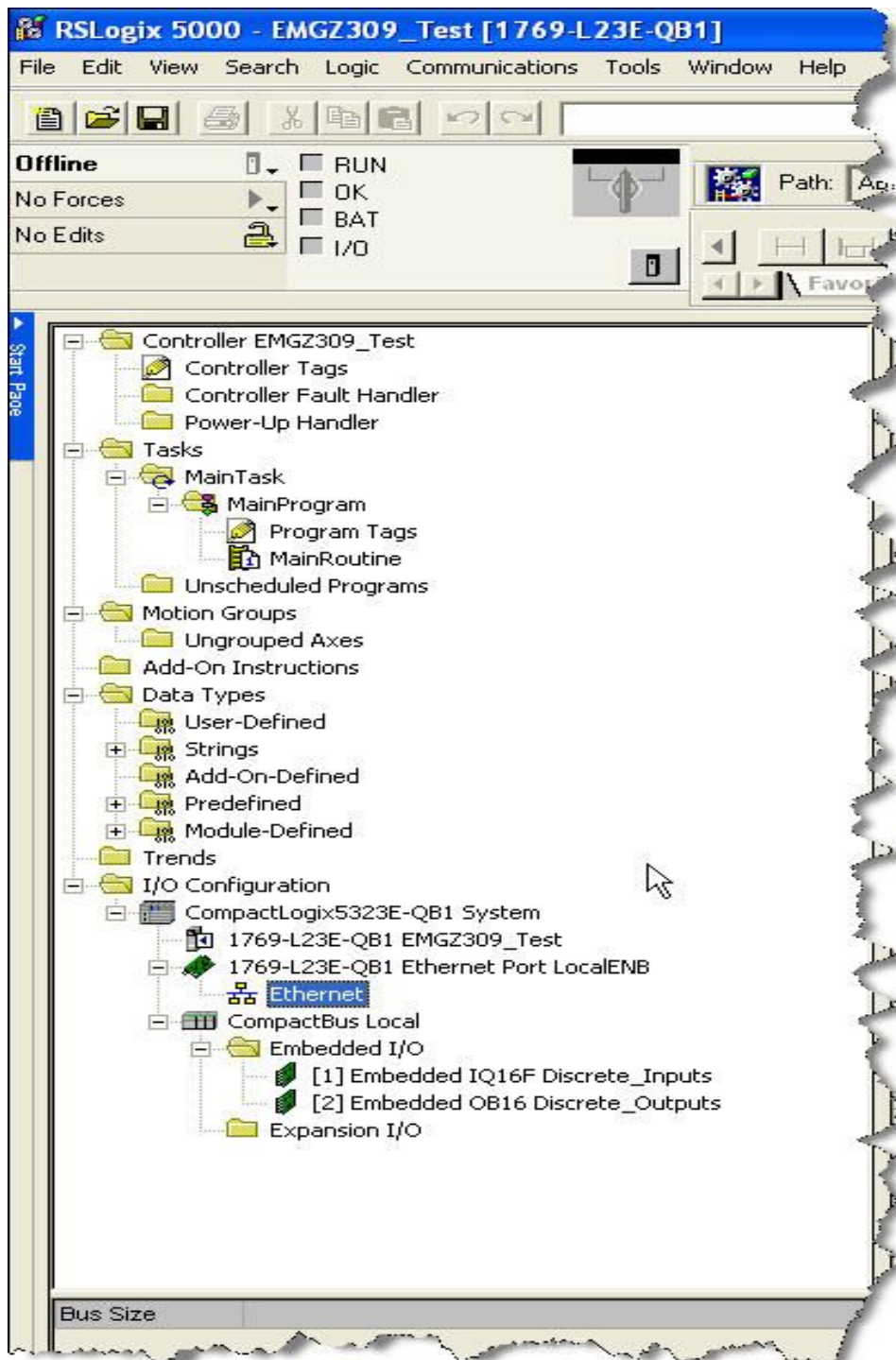

Fig. 11: Controller Organisation

E309021

In this example CompactLogixL23E-QB1B is used. If a different hardware is used, one may find the listing **Ethernet** in another place. However, the principal approach is always the same. After a right mouse click on **Ethernet** a dialog window will open up. Left mouse click on New Module...and a new window will open up (see Fig.12).

Open plus-sign [+] in front of **Communications** to see all the other listings.

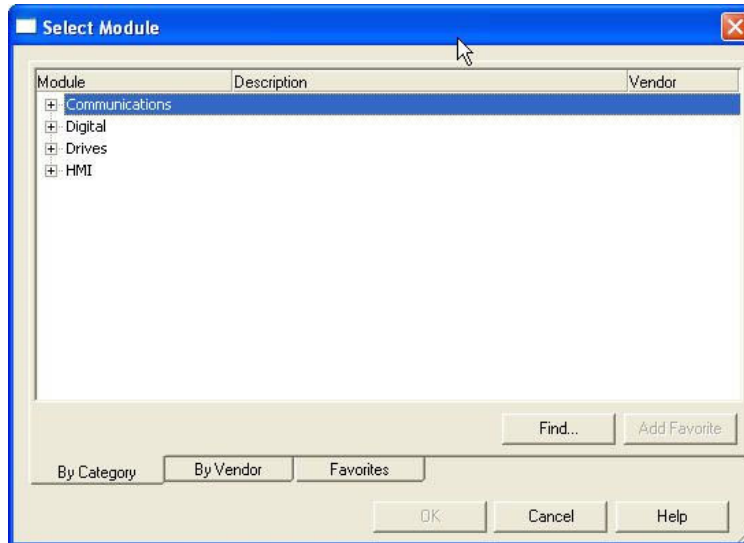

Fig. 12: Module Selection E309022

Select **ETHERNET-MODULE Generic Ethernet Module** and confirm with **OK**.

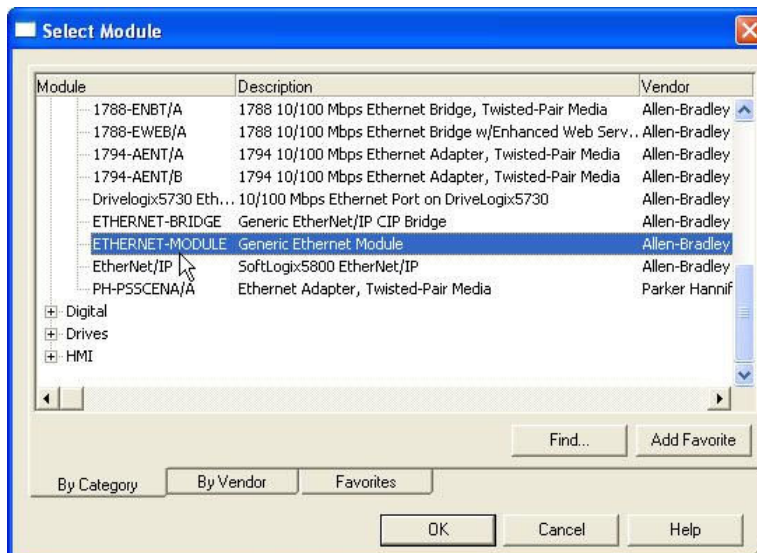

Fig. 13: Module Selection open E309023

Following window opens up in which the **Name CMGZ309_91**, the **Comm Format DINT** and the pre-defined **IP-Address (eg. 192.168.0.91)** need to be entered. On the **Connection Parameters** side the values **Input=100** with **Size 5**, **Output= 101** and **Configuration= 102** with **Size 268** must be entered. Confirm with **OK**.

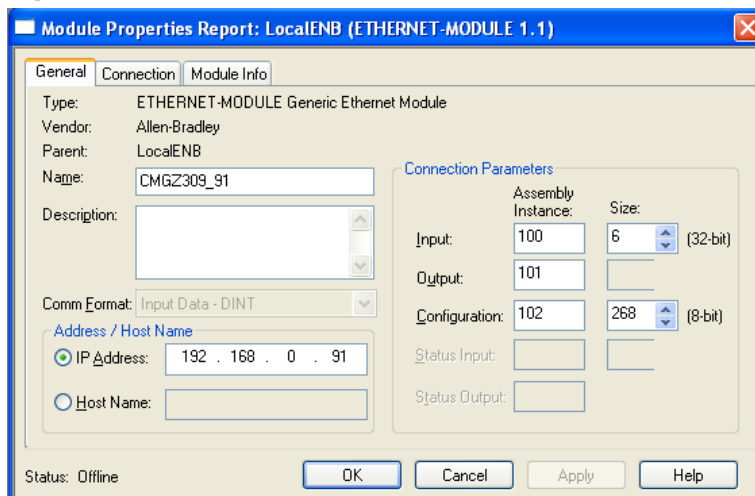

Fig. 14: New Module E309024

The dialog window (Fig. 15) will open up. Here, one can enter the cycle time. This determines how often the data will be propagated in the network. The minimal cycle time is 2 ms. Default setting is 10 ms. Basically the cycle time must be set so that the maximum speed requirements of the system are fulfilled. A fast cycle time leads to more data traffic in the network. That can create communication bottlenecks. Especially when using several other EIP devices in the same network a well-balanced data speed is important.

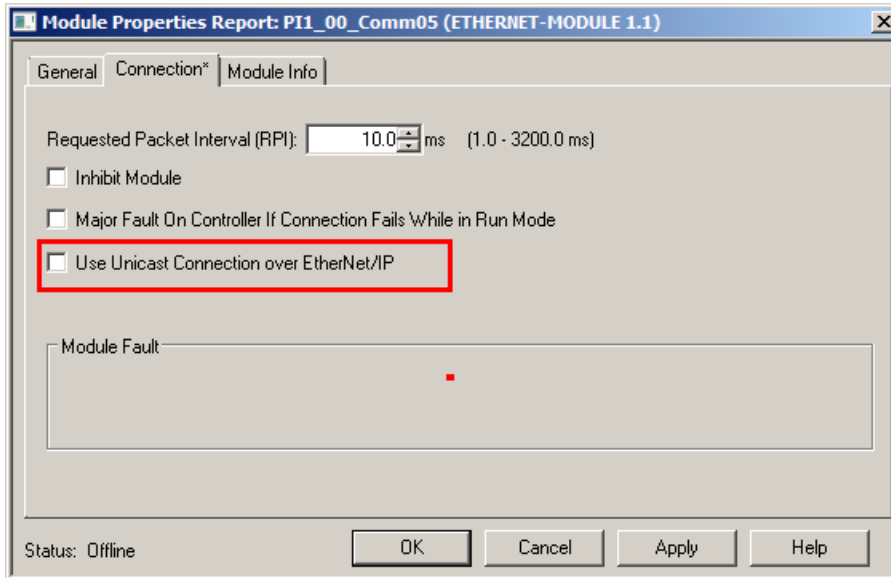

Fig. 15: Module Properties

Note
 Untick the box „Use Unicast Connection over EtherNet/IP“. The use of this feature is not allowed as it will cause communication problems.

7.4 Access to the Tension Values

After the integration of the controller in the network the tension data is available in the global input tags of the controller and that in the defined cycle time. In our example the device was named

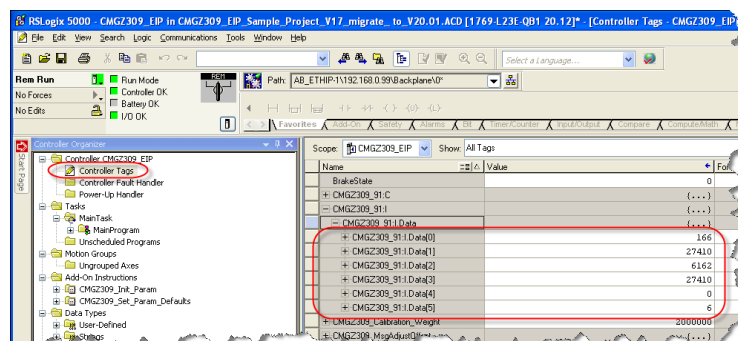

Fig. 16: RSLogix E309026

CMGZ309_91. The tension values can therefore be found under the controller tags **CMGZ309_91:I >> CMGZ309_91:I Data** (Index 0 to 5). The access to the data and its value is marked red in Fig. 16. Assignment of the indices:

Index	Value
-------	-------

- 0 Tension value in digits, unfiltered value
- 1 Tension value in Newton (N) with 3 decimals
- 2 Tension value in Pounds (lbf) with 3 decimals
- 3 Tension value in the configured unit with 3 decimals
- 4 Control value
- 5 Device state, each bit represents a separate state, state is active if the respective bit is set

Bit	State	Bit	State
0	Control active	3	Brake active
1	Relay 1 active	4	State of digital input 1
2	Relay 2 active	5	State of digital input 2

8 Operation

8.1 Operating the CMGZ309 over the Front Panel

The tension controller CMGZ309 can go in 7 different states:

- **Idle State:** Controller not operating but ready
- **Enable State:** Controller active
- **Free-run State:** Break released
- **Display Selection:** Selection of control values on LCD
- **Reference Setting State:** Reference Value can be adjusted
- **Parametrisation State:** Set or change parameters
- **Emergency Stop** Machine stopped

The user can toggle between the different states by pressing a key on the front panel. Fig. 17 and Fig. 18 provide an overview about the different Operation States and how to move from one state to the other.

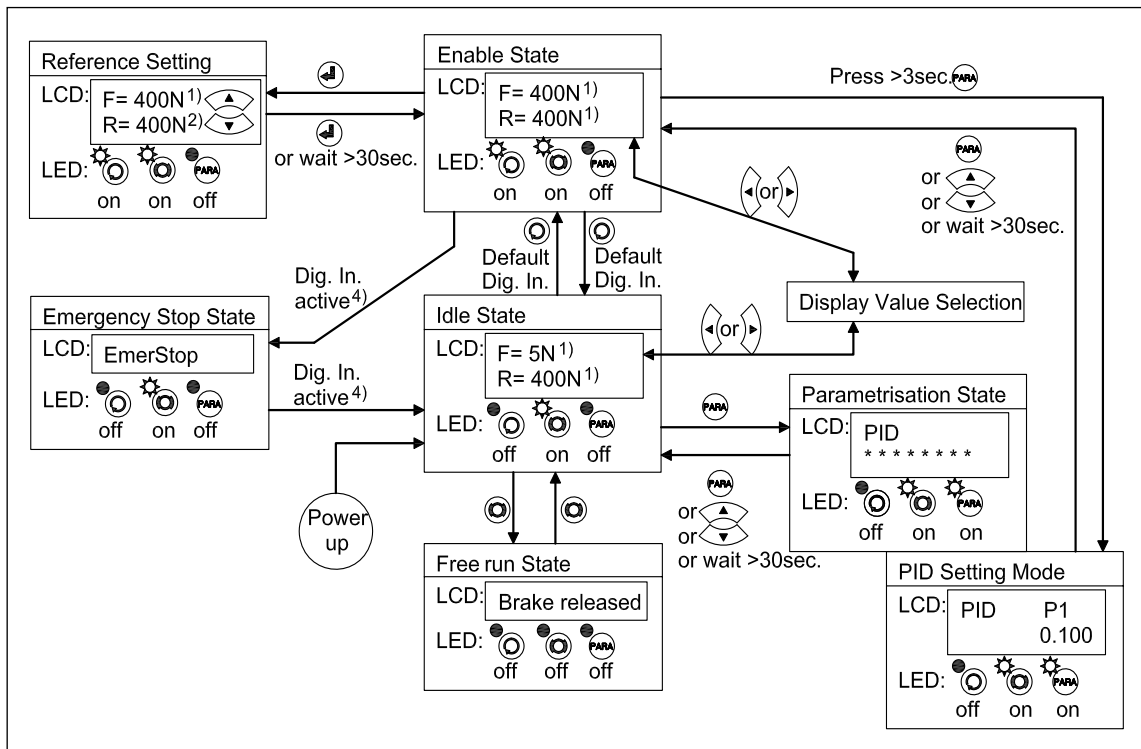

Fig. 17: Top-level view of operation control for brake applications

C309010e

Notes for parameter settings:

- 1) The display shows the unit of measure that was previously selected
- 2) When in “Reference setting” state the “R” on the display starts flashing
- 4) Machine specific emergency stop button triggers Digital Input 1 or 2. This state is only available in an unwind break application.

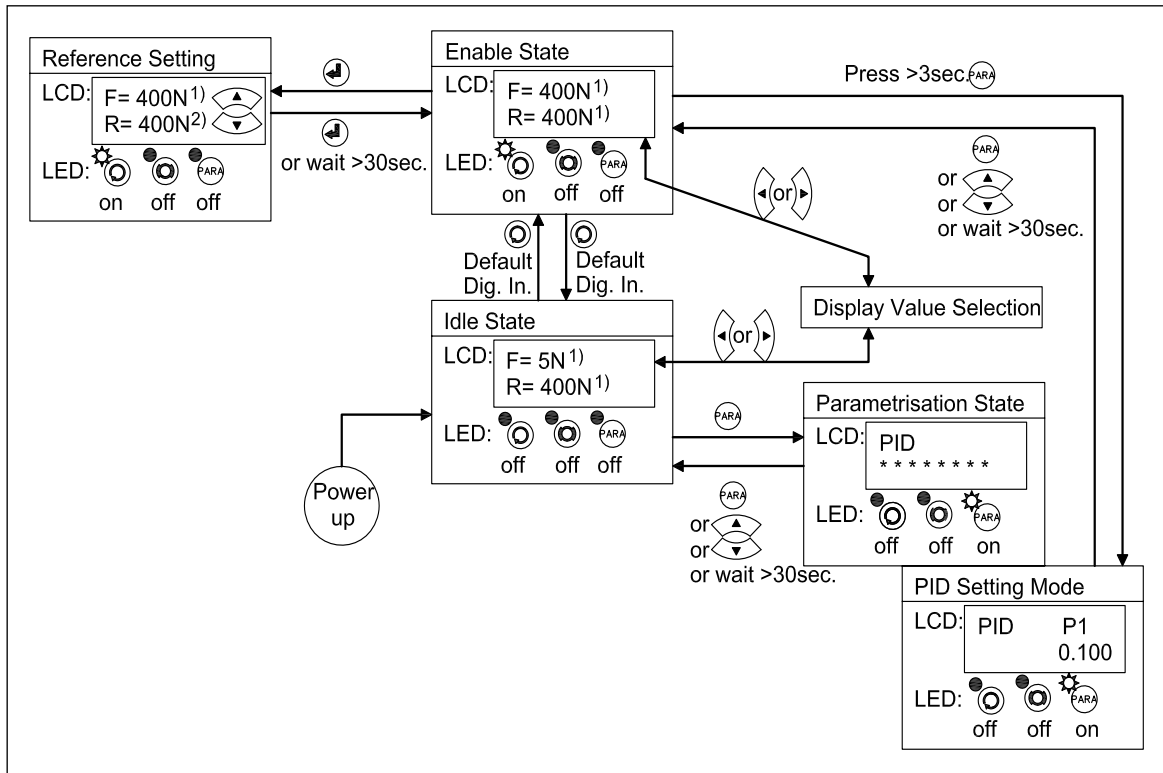

Fig. 18: Top-level view of operation control for drive applications

C309011e

8.2 Display Value Selection State

There are several options to display values that are relevant for the control system. The user can choose between 6 display forms. The Display Selection State can be accessed from

the “Enable State” or “Idle State” via the or key (see Fig. 19).

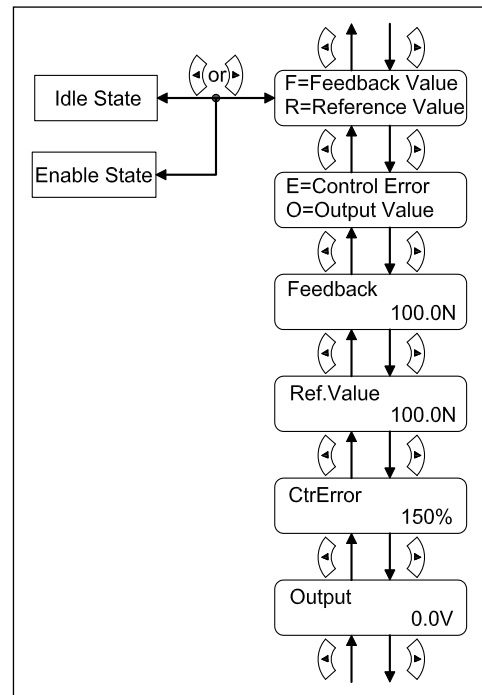



Fig. 19: Display Values C309012e

8.3 Setting the Reference Value

It is sometimes necessary to change the Reference Value during operation. This is either possible in the Parametrisation State or directly in the Operation State. The later method is faster and convenient.

1. Select display containing the Reference Value e.g.
2. Go to “Enable Sate” (see Fig. 17 or 18)
3. Press  to enter the Reference Setting State.
4. Reference Value starts flashing indicating that it can be changed.
5. Confirm your input with the  key.

F= 500.0N
R= 00.0N

or

RefValue
500.0N

9 Parameter Setting over the Front Panel

9.1 Basic Instructions for Parameter Setting

After “Offset compensation” and “Calibration” (see **chapter 5.3** and **5.5**) the system is pre-configured. Moreover, several adjustment procedures can be activated to capture or calculate controlling relevant values which then are stored in the parameter list. Parameter setting state is organised in 7 groups and one adjustment group. In detail these are:

- **PID Parameter Group**
- **Function Parameter Group**
- **Configuration Parameter Group**
- **Amplifier Parameter Group**
- **Adjustment Procedures**
- **Input / Output Parameter Group**
- **System Parameter Group**
- **Service Parameter Group**

The workflow in the Parametrisation State has three basic operator modi:

- **Parameter Group Selection**
- **Parameter Selection within the Group**
- **Parameter Change or Setting**

Parameter setting can be performed via the front panel or via a web browser.

The Parametrisation State can only be accessed from the “Idle State”. From the “Enable State” only the Parameter Group “PID” can be reached (**Fig. 17** and **18**). The tension controller CMGZ309 displays only the parameters that are relevant for a chosen control mode. If you have configured your system e.g. for a Drive Application, no Brake relevant parameters such as *Brake Time*, *Holding Torque* *Diameters* etc. will be displayed. In the following State Diagrams every parameter features a small table which indicates its application field.

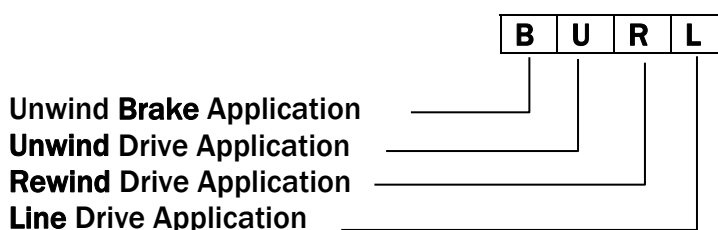

For more details refer to **Fig. 3: “Schematics of CMGZ309 Applications”**.

9.2 PID Parameter Group

The PID Parameter Group contains all parameters to configure the PID close-loop control. P-, I- and D-value can be set individually and stored in two PID-sets.

9.3 Description of PID Parameters

Controller Configuration			LCD: <i>PID Conf</i>					
<p>Use: This parameter defines the control method. CMGZ309 can operate as a PI or or PID controller. If it is operated as a PI controller, the parameters <i>Derivative D1...D4</i> are ineffective.</p>								
Unit	Parameter Range		Selection	Default	Application			
	Min	Max						
-	-	-	PI PID	PI	-	U	R	L

PID Set in Use			LCD: <i>SetinUse</i>					
<p>Use: Two PID parameter sets can be stored in the parameter list. The parameter <i>SetinUse</i> allows the selection of the PID-set that will be adopted to the controller. The selection of the PID-set can also be controlled via the Digital Inputs.</p>								
Unit	Parameter Range		Selection	Default	Application			
	Min	Max						
-	-	-	1 2	1	B	U	R	L

Proportional P1 / P2			LCD: <i>PID P1 or PID P2</i>					
<p>Use: The P-value determines the behaviour of the P-component of the controller. This parameter can be changed while the controller is in enable state. The new value is adopted in the control loop when leaving the parametrisation state.</p>								
Unit	Parameter Range		Selection	Default	Application			
	Min	Max						
-	0.001	30.000	-	0.100	B	U	R	L

Integral I1 / I2			LCD: <i>PID I1 or PID I2</i>					
<p>Use: The I-value determines the behaviour of the I-component of the controller. Parameter change in enable state. The new value is adopted in the control loop when leaving the parametrisation state.</p>								
Unit	Parameter Range		Selection	Default	Application			
	Min	Max						
s	0.001	30.000	-	0.100	B	U	R	L

Derivative D1 / D2			LCD: PID D1 or PID D2					
<p>Use: The D-value determines the behaviour of the D-component of the controller. This parameter can be changed while the controller is in enable state. The new value is adopted in the control loop when leaving the parameter mode.</p>								
Unit	Parameter Range		Selection	Default	Application			
	Min	Max						
s	0.0000	3.0000	-	0.0000	-	U	R	L

9.4 Function Parameter Group

The Function Parameter Group contains all parameters to ensure a proper control in the target application (e.g. in an Unwind Brake, Rewind Drive or another application).

Description of Function Parameters

Control Mode			LCD: CtrMode					
<p>Use: This parameter defines the type of actuator and its application in the control loop. The user may select four different modes Unwind Brake, Unwind Drive, Rewind Drive and Line Drive (ref to Fig. 3: Schematics of CMGZ309 applications).</p>								
Unit	Parameter Range		Selection	Default	Application			
	Min	Max						
-	-	-	<i>UnwBrake</i> <i>UnwDrive</i> <i>RewDrive</i> <i>LineDrive</i>	<i>UnwBrake</i>	B	U	R	L

Torque in Use			LCD: Torque				
<p>Use: If this parameter is set to <i>no</i> and the controller is disabled, the output value will be 0V. When the controller is enabled, the value set under parameter <i>Holding torque</i> appears at the output. The controller starts from the holding torque value when enabled.</p> <p>If this parameter is set to <i>yes</i> and the controller is disabled, the output contains a value that corresponds always to the parameter <i>Holding torque</i>. The controller always brakes with the holding torque as long as it is disabled. After enabling the controller, it starts from the holding torque and returns to the holding torque if the controller is disabled again.</p> <p>If the parameter <i>“Pilot Control”</i> is set to <i>“No”</i> the holding torque corresponds to the value stored the parameter <i>HT d Max</i> (there is no diameter signal).</p> <p>If the parameter <i>“Pilot Control”</i> is set to <i>“Yes”</i> the holding torque corresponds to the torque of the actual diameter value (there is diameter signal).</p>							
Unit	Parameter Range		Selection	Default	Application		

	Min	Max						
-	-	-	Yes No	No	B	-	-	-

Pilot Control				LCD: <i>PilotCtr</i>			
<p>Use: With this parameter, the pilot control can be turned on and off. That means that the utilization of the reel diameter signal will be activated or de-activated. Refer to 11.7 “Setup of Pilot Control”.</p>							
Unit	Parameter Range		Selection	Default	Application		
	Min	Max			B	U	R
-	-	-	Yes No	No	B	U	R

Taper Function				LCD: <i>TaperFct</i>			
<p>Use: To cope with the unequal tensions requirements of an empty or full reel, the Taper Function can be introduced in the control loop. The parameter <i>TaperFct</i> initialises the function. If the selection was set to “Yes”, the controller will request information about reel diameters. This information must be entered in the Configuration Parameter Group in the respective parameters <i>MinTaper</i>, <i>MaxTaper</i>, <i>Ref25%d</i>, <i>Ref50%d</i>, <i>Ref75%d</i>, <i>Ref100%d</i>.</p>							
Unit	Parameter Range		Selection	Default	Application		
	Min	Max			-	-	R
-	-	-	Yes No	No	-	-	R

Position Line Drive				LCD: <i>PosLnDrv</i>			
<p>Use: The output value of the controller depends on the position of the line drive. Either being mounted before or after the force sensors, the position determines the polarity of the output value ((ref. to Fig. 3).</p>							
Unit	Parameter Range		Selection	Default	Application		
	Min	Max			-	-	L
-	-	-	<i>Ahead</i> <i>After</i>	<i>Ahead</i>	-	-	L

Line Speed Overlay			LCD: v Overlay					
<p>Use: If this parameter is set to “Yes”, the actual line speed signal is overlaid to the PID controller output. This will improve controller dynamics significantly. Refer to 14.2 “Setup of Line Speed Overlay”</p>								
Unit	Parameter Range		Selection	Default	Application			
	Min	Max						
-	-	-	Yes No	No	-	-	-	L

9.5 Configuration Parameter Group

Via the Configuration Parameter Group the controller can be tuned and optimised to the respective application.

9.6 Description of Configuration Parameters

PID Influence			LCD: PIDInflu					
<p>Use: If pilot control or line speed overlay is activated, this parameter defines the proportion in percentage of the PID controller adding to the pilot control or line speed signal. E.g. if 10% was entered, it means that 10% of the output signal is contributed by the PID. If pilot control or line speed overlay is not activated, the effective influence of PID is 100%, regardless of the value of this parameter</p>								
Unit	Parameter Range		Selection	Default	Application			
	Min	Max						
%	0.1	100.0	-	100.0	B	U	R	L

Holding Torque Maximum Diameter			LCD: HT d Max			
<p>Use: If the Parameter <i>PilotCtrl</i> is set to “No”: The controller outputs the actual holding torque of the roller at standstill. The holding torque must be chosen such that the roller stands still but does not tear the material apart when restarted. If the parameter <i>Torque</i> is set to “No” the holding torque will only be at the output if the controller is enabled. If the parameter <i>Torque</i> is set to yes the holding torque will already be at the output before the controller is enabled. “10” means 10% of Output, hence 10% of 10V = 1.0V. Parameter <i>Pilot Control</i> set to “Yes”: The required holding torque for the larger diameter is given to the output. A diameter signal must be applied. The stored value is proportional to the diameter and can be accessed in the service module under the parameter <i>Holding torque, U@TrqMax</i>.</p>						

Unit	Parameter Range		Selection	Default	Application			
	Min	Max			B	-	-	-
%	0.0	100.0	-	0.0	B	-	-	-

Holding Torque Minimum Diameter	LCD: <i>HT d Min</i>
--	-----------------------------

Use: Parameter *Pilot Control* set to “No”:
At this stage the parameter has no function.
Parameter *Pilot Control* set to “Yes”:

The required holding torque for the smaller diameter is given to the output. However, a diameter signal must be applied. The actual diameter signal must be stored. The stored value is proportional to the diameter and can be accessed in the service module under the parameter *Holding torque, U@TrqMin*.

Unit	Parameter Range		Selection	Default	Application			
	Min	Max			B	-	-	-
%	0.0	100.0	-	0.0	B	-	-	-

Start Time	LCD: <i>t Start</i>
-------------------	----------------------------

Use: After controller enable, the output is 0V or equal the holding torque. The output value will increase linearly during the time specified in *Start time* towards the maximum (10V) as long as the value specified in “start limit” is not reached.

The *Start Time* is defined in seconds. A low value gives a faster increase of the output value. A long *Start Time* gives a slower increase. The value 0.0 will disable this function.

Unit	Parameter Range		Selection	Default	Application			
	Min	Max			B	-	-	-
s	0.0	100.0	-	0.0	B	-	-	-

Start Speed	LCD: <i>v Start</i>
--------------------	----------------------------

Use: If the material is hanging loosely during enabling the controller, the controller would rewind the material with maximum speed to build up the needed material tension. Due to the inertia of drive unit the web would tear up. Therefore, the controller starts with low speed (parameter *v Start*) until an initial material tension stored in parameter *StartLim* is reached.
„10“ refers to 10% of the maximum output value, depending on output mode (parameter *Out Mode*).
If the parameter *Out Mode* is set to $\pm 10V$ and the operation mode (parameter *CtrMode*) is at unwind drive the output value is negative (for ex. 5% will result in an output signal of -0.5V).

Unit	Parameter Range		Selection	Default	Application			
	Min	Max			-	U	R	-
%	0.00	100.00	-	0.00	-	U	R	-

Start Limit			LCD: <i>StartLim</i>					
<p>Use: Break: After controller enable, the output is 0V or equal to the holding torque. The output will increase linearly towards the maximum (10V) as long as the start limit value is not reached.</p> <p>The start limit value is entered in percent of the actual reference value. If the feedback value is reaching the start limit value, the PID controller will take over after synchronization.</p> <p>Drives: Description and function see <i>Start speed</i> „90“ means 90% of reference value in N.</p>								
Unit	Parameter Range		Selection	Default	Application			
	Min	Max						
%	0.0	100.0	-	0.0	B	U	R	-

Brake Time			LCD: <i>t Brake</i>					
<p>Use: If the controller is disabled, the output value will be multiplied with the parameter <i>Booster</i> as long as the brake time (parameter <i>t Brake</i>) is active. The brake time is defined in seconds and determines how long the brake <i>booster</i> is applied to the brake. Did the brake time run out, the output value will be 0 or equal to holding torque.</p> <p>The value 0.0 will disable this function.</p>								
Unit	Parameter Range		Selection	Default	Application			
	Min	Max						
s	0.0	100.0	-	0.0	B	-	-	-

Brake Booster			LCD: <i>Booster</i>					
<p>Use: If the controller is disabled, the output value will go to the last output value multiplied by the value specified in the parameter <i>Booster</i> and keep this value for the time specified in the parameter <i>t Brake</i> (Brake time). The <i>Booster</i> value is specified in percentage of the output value before the controller is disabled. If the time specified in the parameter <i>t Brake</i> is over, the output value will be 0 or equal to the holding torque.</p>								
Unit	Parameter Range		Selection	Default	Application			
	Min	Max						
%	0.0	300	-	0	B	-	-	-

Feed Back Value Range			LCD: <i>FBRange</i>			
<p>Use: This parameter allows holding the feedback value within a defined range. Feedback values exceeding this range are limited. Thus extreme peaks of the control output value are avoided in case of high variations of the tension feedback value (i.e. with rough running reels). This allows</p>						

setting the PID parameters more sensitive despite poor machine conditions. The feedback value in the display is not influenced. The percentage refers to the tension reference value. For example a setting of 80% with a reference value of 100N limits the feedback value to $\pm 80N$ max. If the parameter is set to 100% the function is disabled.

Unit	Parameter Range		Selection	Default	Application			
	Min	Max			B	U	R	L
%	1.0	100.0	-	100.0	B	U	R	L

Ramp Diameter			LCD: <i>d Ramp</i>					
Use:	To prevent interferences on the controller, the unwind/rewind diameter should not change too fast. The diameter signal is therefore led internally to a ramp. The parameter defines the rate of rise of the ramp. The length of the ramp defines the time the diameter will take for a change of 1mm.							
Unit	Parameter Range		Selection	Default	Application			
	Min	Max			B	U	R	-
s	0.1	60.0	-	1.0	B	U	R	-

Ramp Reference			LCD: <i>RampRef</i>					
Use:	To prevent interferences on the controller, the reference value should not change too fast. The reference signal is therefore led internally to a ramp. The parameter defines the rate of rise of the ramp. The length of the ramp defines the settling time from old reference value to the new.							
Unit	Parameter Range		Selection	Default	Application			
	Min	Max			B	U	R	L
s	0.1	20.0	-	1.0	B	U	R	L

Scale Reference Input			LCD: <i>ScaleRef</i>					
Use:	This parameter defines what force value corresponds to 10V on the analogue reference input.							
Unit	Parameter Range		Selection	Default	Application			
	Min	Max			B	U	R	L
N ¹⁾	0.0	100'000.0	-	1000.0	B	U	R	L

¹⁾ The display shows the unit of measure that was previously selected

Ratio Line Speed and Output			LCD: <i>Ratio</i>					
Use:	This parameter determines the ration between the line speed input and the control output. It is used for the line speed overlay function.							

Unit	Parameter Range		Selection	Default	Application			
	Min	Max			-	-	-	L
-	0.010	20.000	-	1.0	-	-	-	L

Minimum Taper			LCD: <i>MinTaper</i>					
Use: This parameter is used for the taper function. It stores the diameter of the reel in empty conditions.								
Unit	Parameter Range		Selection	Default	Application			
	Min	Max			-	-	R	-
mm	0.1	5000.0	-	100.0	-	-	R	-

Max Taper			LCD: <i>MaxTaper</i>					
Use: This parameter is used for the taper function. It stores the diameter of the reel in fully winded conditions.								
Unit	Parameter Range		Selection	Default	Application			
	Min	Max			-	-	R	-
mm	0.1	5000.0	-	1000.0	-	-	R	-

Reference Value at 25...100% of Maximum Reel Diameter			LCD: <i>Ref25%d, Ref50%d, Ref75%d, Ref100%d</i>					
Use: These four parameters are used for the taper function. The tension reference value can be set at 25% / 50% / 75% and 100% of the maximum reel diameter (ref. 13.5 "Taper Function"). The taper function relates to the start reference value at minimum diameter. It has to be entered via the operating panel or the Web Browser.								
Unit	Parameter Range		Selection	Default	Application			
	Min	Max			-	-	R	-
%	1	5000	-	100	-	-	R	-

9.7 Amplifier Parameter Group

In Amplifier Parameter Group parameters related to the strain gauge amplifier can be set.

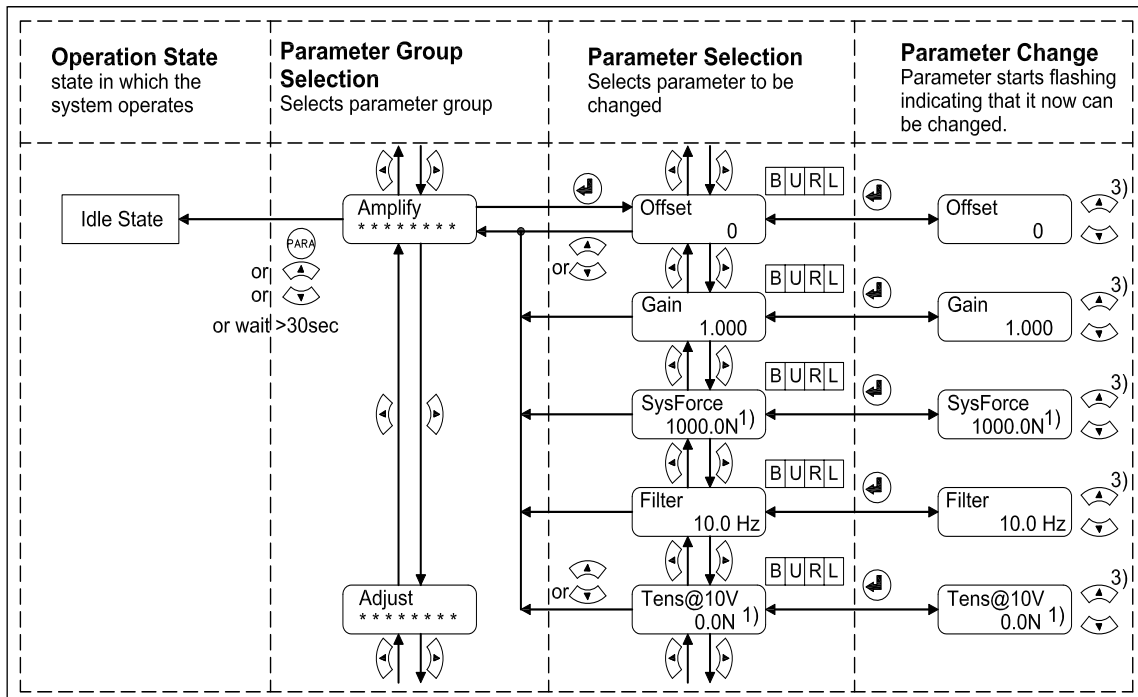

Fig. 24: State Diagram Amplifier Parameter Group

C309017e

- 1) The display shows the unit of measure that was previously selected
- 3) Permanent key pressing expedites the changing speed of the value.

9.8 Description of Amplifier Parameters

Offset of Reference Value			LCD: Offset					
Use:		The value determined with the adjustment procedure <i>Find Offset</i> is stored as a Digit value in the parameter <i>Offset</i> . The offset value is used to compensate the roller weight (see 5.3 "Offset Compensation").						
Unit	Parameter Range		Selection	Default	Application			
	Min	Max						
Digit	-8000	+8000	-	0	B	U	R	L

Gain of Amplifier			LCD: Gain					
<p>Use: This parameter stores the value determined with the Adjustment Procedure <i>Calibration</i> (see 5.5 “Calibration Procedure”). Alternatively you can input a calculated value using the FMS Calculator described in paragraph 5.4 “Calibrating Methods“, if the material tension cannot be simulated.</p>								
Unit	Parameter Range		Selection	Default	Application			
	Min	Max						
-	0.100	20.000	-	1.0	B	U	R	L

System Force			LCD: SysForce					
<p>Use: This parameter stores the system force of your force measuring roller. The nominal force is printed on the label of each force sensor. You have to enter the force you have installed in your measuring roller. E.g. if you have a roller with two 250N sensors, enter the system force 500N.</p>								
Unit	Parameter Range		Selection	Default	Application			
	Min	Max						
N, kN, g, kg, lb ¹⁾	1.0	100'0000.0	-	1000.0	B	U	R	L

¹⁾ The display shows the unit of measure that was previously selected

Filter			LCD: Filter					
<p>Use: The CMGZ309 contains a lowpass filter to prevent noise overlaying to the feedback signal. This parameter stores the cut off frequency of the filter. The lower the cut off frequency, the more sluggish the feedback signal will be. The filter stabilizes the feedback signal in case of highly fluctuating force values. This filter is independent from the display filter (described in 9.14 “System Parameter Group”).</p>								
Unit	Parameter Range		Selection	Default	Application			
	Min	Max						
Hz	0.1	200.0	-	10.0	B	U	R	L

Tension at 10V			LCD: Tens@10V					
<p>Use: This parameter defines what force value (e.g. N) corresponds to the maximum output 10V or 20mA.</p>								
Unit	Parameter Range		Selection	Default	Application			
	Min	Max						
N, kN, g, kg, lb ¹⁾	1.0	100'000.0	-	1'000.0	B	U	R	L

9.9 Adjustment Procedures

In the Adjustment Group no parameter setting is performed. In fact the procedures in this group serve to offset the weight of the measuring roller, calibrate the system, adjust diameters for the Taper Function or setup Pilot Control.

9.10 Description of Adjustment Procedures

Offset Compensation Procedure	LCD: <i>Offset</i>
<p>Use: With the Offset Compensation procedure the roller weight can be compensated. It is always performed before the Calibration procedure. The value for offsetting the roller weight is stored in the parameter <i>Offset</i> (see 9.9 “Description of Amplifier Parameters”).</p>	
<hr/>	

Calibration Procedure	LCD: <i>Calibration</i>
<p>Use: This Procedure calculates the value for the amplifier gain (see 5.4 “Calibration Procedure”). The procedure requests inputs such as the system force and the force corresponding to the calibration weight. The here determined values are stored in the parameter <i>Gain</i> and <i>SysForce</i> in the Amplifier Parameter Group. If the measuring roller can’t be calibrated with a weight (e.g. due to difficult accessibility) the gain can alternatively be calculate with the FMS Calculator tool and then entered in the parameter <i>Gain</i> (see 9.9 “Description of Amplifier Parameters”).</p>	
<hr/>	

Adjustment of the Diameter Sensor	LCD: <i>Diameter</i>
<p>Use: A pilot control configuration (implying reel diameter in the control system) requires the use a diameter sensor. This procedure enables the integration of the diameter sensor in the close loop control system. The adjustment procedure requests inputs such as the diameter of the empty and full reel <i>d2 Value</i> and <i>d2 Value</i>. It then measures the voltage at these particular reel diameters and stores them in the parameters <i>U@d1</i> and <i>U@d2</i> (see 9.17 “Description of Service Parameters”).</p>	
<hr/>	

Adjustment of Pilot Control	LCD: <i>PilotCtr</i>
<p>Use: This adjustment procedure allows the setup and tuning of a pilot control. The procedure requests inputs such as a percentage of the output value (portion of torque taken over by the pilot control) and the actual Reference Value. With these inputs the system will calculate the correspondent parameters and store them in <i>PilotCtr</i>, <i>PilotRef</i> and <i>Pilot d</i> in the Service Parameter Group. Please read carefully chapter 11.7 “Setup of Pilot Control” before adjusting the Pilot Control.</p>	
<hr/>	

9.11 Input / Output Parameter Group

This parameter group contains the parameters to configure the in- and outputs of the controller creating so the necessary interfaces to periphery devices and system components.

9.12 Description of Input / Output Parameters

Digital Input 1 and 2			LCD: <i>Input 1 or Input 2</i>					
Use: Each digital input can be configured individually and can perform an assign special function. The digital inputs are either level or edge triggered. See also 4.7 "Digital Inputs".								
Unit	Parameter Range		Selection	Default	Application			
	Min	Max			B	U	R	L
-	-	-	LevI→Ctr Edge→Ctr Disabled SelcPID EmerStop LevI→BRe Edge→BRe	<i>Input 1 and 2:</i> Disabled				

Enable Control, level triggered *Levl →Ctr*

Makes the control loop to change from Idle State to Enable State and vice versa.

Enable Control, Edge triggered *Edge →Ctr*

Makes the control loop to change from Idle State to Enable State and vice versa.

Disabled

This selection disables the digital input.

Select PID *SelcPID*

The parameter *SelcPID* selects the alternative PID set.

Emergency Stop *EmerStop*

The parameter *EmerStop* is an auxiliary function to realise an Emergency-stop-concept. If used, the function can activate a break.

Brake Release, level triggered *Levl →BRe*

Releases the brake in an Unwind Brake application. This function is also performed with the  key in the front panel as long as it wasn't already assigned to a digital input.

Brake Release, edge triggered *Edge →BRe*

Releases the brake in an Unwind Brake application. This function is also performed with the  key in the front panel as long as it wasn't already assigned to a digital input.

Reference Source			LCD: RefSourc					
Use: If the Reference Value is entered via the front panel or a Web Browser the parameter must be set to <i>Internal</i> . If a 0...10V signal from an external source is used, the parameter must be set to <i>Extern</i> .								
Unit	Parameter Range		Selection	Default	Application			
	Min	Max						
-	-	-	<i>Internal</i> <i>External</i>	<i>Internal</i>	B	U	R	L

Output Mode Selection			LCD: Out Mode					
Use: This parameter selects the output signal. With setting $\pm 10V$, the drive unit is able to drive or brake and run both in forward and reverse direction. With the other settings, the drive unit can only drive a brake in one direction. FMS recommends using the setting $\pm 10V$ in combination with a 4-quadrant drive unit. If a brake unit is used, the other settings are preferred.								
Unit	Parameter Range		Selection	Default	Application			
	Min	Max						
-	-	-	<i>0..10V</i> <i>0..20mA</i> <i>4..20mA</i> <i>+/- 10V</i>	<i>0..10V</i>	B	U	R	L

Relay Output 1 and 2			LCD: Relay 1 or Relay 2					
Use: If a defined limit condition is violated the relay output will be activated. Each relay output can be configured individually (see also 4.8 "Relay Outputs"). The user can choose between five scan criteria.								
Unit	Parameter Range		Selection	Default	Application			
	Min	Max						
-	-	-	<i>Limit 1</i> ⁶⁾ <i>Limit 2</i> ⁶⁾ <i>CtrError</i> ⁶⁾ <i>Ctr ON</i> ⁶⁾ <i>Disabled</i> ⁶⁾	<i>Relay 1=</i> <i>Limit1</i> <i>Relay 2=</i> <i>CtrError</i>	B	U	R	L

⁶⁾ These selections can only be assigned to a relay once. If the scan criterion is already assigned to a relay, it won't be available for the other relay and it won't be displayed. The selection *Disabled* can be assigned to both relays.

Limit Value 1 *Limit 1*

The relay output will be activated, if the value stored in the parameter *Limit 1* is over or undershot (depending on the chosen Limit condition).

Limit Value 2 *Limit 2*

The relay output will be activated, if the value stored in the parameter *Limit 2* is over or undershot (depending on the chosen Limit condition).

Control Error too high *CtrError*

The relay output will be activated, if the value stored in the parameter *CtrErro* is over or undershot (depending on the chosen Limit

Control ON *Ctr ON*

The selection *Ctr ON* sets the relay output active, if the controller is enabled.

Disabled

This selection disables the relay output.

Limit Condition Relay Output 1	LCD: <i>LimCond1</i>
Limit Condition Relay Output 2	LCD: <i>LimCond2</i>

Use: The *LimCond1* determines whether the relay output must be activated when over-shooting (> Limit) or under-shooting (< Limit) the value stored in the Parameter *Limit 1*. Analogously this holds for *LimCond2*.

Unit	Parameter Range		Selection	Default	Application			
	Min	Max			B	U	R	L
-	-	-	< <i>Limit</i> > <i>Limit</i>	<i>R1</i> = < <i>Limit</i> <i>R2</i> = > <i>Limit</i>	B	U	R	L

Limit 1 and Limit 2	LCD: <i>Limit 1</i> or <i>Limit 2</i>
----------------------------	---------------------------------------

Use: The two parameters *Limit 1* and *Limit 2* determine the limit value to activate the relay.

Unit	Parameter Range		Selection	Default	Application			
	Min	Max			B	U	R	L
N ¹⁾	0.1	100'000.0	-	100.0	B	U	R	L

Control Error			LCD: <i>CtrError</i>					
<p>Use: The relay output will be activated, if the threshold value stored in the parameter <i>CtrError</i> is exceeded or falls below the value (dependent on the setting in parameter <i>LimCond</i>). <i>CtrError</i> has to be entered as a percentage value. It bases on the formula (Control Error= Feedback value - Reference value)*100 / Reference value.</p>								
Unit	Parameter Range		Selection	Default	Application			
	Min	Max			B	U	R	L
%	1.0	100.0	-	10.0	B	U	R	L

Maximum Brake Current			LCD: <i>Brake</i>					
<p>Use: This parameter selects the current driving strength of the brake amplifier. This parameter is only for the controller version CMGZ309.W.B. relevant.</p>								
Unit	Parameter Range		Selection	Default	Application			
	Min	Max			B	U	R	L
A	0.125	2	0.125 0.25 0.5 1 2	0.125	B	-	-	-

Signal of Diameter Sensor			LCD: <i>d Signa</i>					
<p>Use: The <i>d Signa</i> parameter determines the type of diameter sensor used in the application. There are sensors behaving proportional to the diameter value (e.g. an increase of the diameter results in a increase of the voltage signal). Other sensors behave inverse proportional.</p>								
Unit	Parameter Range		Selection	Default	Application			
	Min	Max			B	U	R	L
-	-	-	<i>Proporti</i> <i>Reciprop</i>	<i>Proporti</i>	B	U	R	L

9.13 System Parameter Group

The System Parameter Group contains basic parameters that determine the general characteristics of the controller but that don't influence the controlling performance.

9.14 Description System Parameters

Password			LCD: <i>Password</i>					
<p>Use: The controller can be protected from unauthorised access by means of password. If <i>Password Yes</i> is chosen, the system will request the password to change parameters and other setting. The password itself can't be changed. It is always 3231.</p>								
Unit	Parameter Range		Selection	Default	Application			
	Min	Max						
-	-	-	No Yes	No	B	U	R	L

Language			LCD: <i>Language</i>					
<p>Use: This parameter determines the displayed language. The user can choose between the two languages: English and German. The menu navigation in the web browser is always in English.</p>								
Unit	Parameter Range		Selection	Default	Application			
	Min	Max						
-	-	-	<i>English</i> <i>German</i>	<i>English</i>	B	U	R	L

Unit of Measure			LCD: <i>Unit</i>					
<p>Use: This parameter determines the unit system used.</p>								
<p> Note: By changing the units to <i>lb</i> (pounds) the whole unit system will change from metric to imperial units.</p>								
Unit	Parameter Range		Selection	Default	Application			
	Min	Max						
-	-	-	<i>N</i> <i>kN</i> <i>g</i> <i>kg</i> <i>lb</i>	<i>N</i>	B	U	R	L

Display Filter			LCD: <i>Dis.Filt</i>					
<p>Use: The controller provides a lowpass filter to prevent noise disturbing the LCD or when there is a high fluctuation of the force values. The parameter <i>Dis.Filt</i> stores the cut off frequency of the filter. The lower the cut off frequency, the more sluggish the display will be. A correctly tuned filter will steady the value shown in the display. The display filter does not influence the feedback signal filter described in 9.9 “Description of Amplifier Parameters”).</p>								
Unit	Parameter Range		Selection	Default	Application			
	Min	Max						
Hz	0.1	10.0	-	1.0	B	U	R	L

Ethernet IP Address			LCD: <i>IP Addr.</i>					
<p>Use: The parameter assigns an IP address to the controller. This enables the user to communicate via a web browser with the controller that is imbedded in a network. The IP address must be entered in 4 separate blocks (IP Bl. 1; IP Bl. 2; IP Bl. 3; and IP Bl. 4)</p>								
Unit	Parameter Range		Selection	Default	Application			
	Min	Max						
-	000.000 000.000	255.255. 255.255	-	192.168. 000.090	B	U	R	L

Subnet Mask Address			LCD: <i>Subnet</i>					
<p>Use: The parameter assigns the Subnet Mask of the controller in the Ethernet network. This enables the user to communicate via a web browser with the controller. The Subnet Mask must be entered in 4 separate blocks (Sub. BI 1; Sub. BI 2; Sub. BI 3; and Sub. BI 4).</p>								
Unit	Parameter Range		Selection	Default	Application			
	Min	Max						
-	000.000 000.000	255.255. 255.255	-	255.255. 255.000	B	U	R	L

LAN Speed			LCD: <i>LANSpeed</i>					
Use: <i>LANSpeed</i> determines the data speed of the tension controller to communicate with the receiver (Switch, Hub or PC).								
Unit	Parameter Range		Selection	Default	Application			
	Min	Max						
MBPS			100 10	100	B	U	R	L

Default Settings			LCD: <i>Default</i>					
Use: This menu point is a command. It resets the parameters to the factory settings. If <i>Not Set</i> is chosen, all parameters stay as set by the user. If <i>Yes</i> is chosen, the default parameters are loaded.								
Unit	Parameter Range		Selection	Default	Application			
	Min	Max						
-	-	-	<i>Not set</i> <i>Yes</i>	<i>Not set</i>	B	U	R	L

9.15 Service Parameter Group

The Service Parameter Group contains a number of parameters that are determined via Adjustment Procedures. It's possible to change these parameters here in the Service Parameter Group but it is not advisable. The changes will be overwritten when the Adjustment Procedure is restarted. Service Parameters are mainly used by service engineers. They provide a good overview of the controller settings in case of technical difficulties.

9.16 Description of Service Parameters

Output			LCD: <i>Output</i>					
<p>Use: In Manual Operation mode the Output Value can be changed manually (see chapter 10.4 "Manual Operation"). The value is stored in the parameter <i>Output</i>. If this parameter is called the first time then the outputted value will be 0. The value acts on the analogue output only as long as the controller is in Manual Operation. When leaving the parameter setting state the adjusted value will be stored and it will be used as an initial value for the output when restarting Manual Operation.</p>								
Unit	Parameter Range		Selection	Default	Application			
	Min	Max						
%	0	100	-	0	B	U	R	L

Reference 1 and 2			LCD: <i>Ref 1</i> or <i>Ref 2</i>					
<p>Use: The reference values entered in the Reference Setting State are stored under <i>Ref 1</i> and <i>Ref 2</i> (see Fig. 17 and 18). <i>Ref 1</i> and <i>Ref 2</i> are assigned to the corresponding PID parameter set. To toggle from one reference value to the other one it is necessary to change the PID parameter set.</p>								
Unit	Parameter Range		Selection	Default	Application			
	Min	Max						
N ¹⁾	0.0	100'000.0	-	100.0	B	U	R	L

Reel Diameter 1 and 2			LCD: <i>d1 value</i> or <i>d2 value</i>					
<p>Use: The reel diameters determined by the procedure <i>Adjustment of the Diameter Sensor</i> are stored in these two parameters <i>d1 value</i> or <i>d2 value</i>. Whereas <i>d1</i> stores the diameter of the fully winded reel, <i>d2</i> contains the one of the empty reel.</p>								
Unit	Parameter Range		Selection	Default	Application			
	Min	Max						
mm	1	5000	-	10000	B	U	R	L

Reel Diameter Signal 1 and 2			LCD: <i>U@d1</i> and <i>U@d2</i>			
------------------------------	--	--	----------------------------------	--	--	--

Use: The corresponding electrical signals (generated by the diameter sensor) of <i>d1</i> value or <i>d2</i> value are stored in <i>U@d1</i> and <i>U@d2</i> .					
Unit	Parameter Range		Selection	Default	Application
	Min	Max			
V	0.00	10.00	-	0.0	B U R L

Pilot Control			LCD: <i>PilotCtr</i>		
Use: This parameter stores the reference value at the time the <i>Pilot control</i> has been setup (9.10 “Adjustment Procedure”).					
Unit	Parameter Range		Selection	Default	Application
	Min	Max			
%	0.00	100.0	-	0.0	B U R L



Pilot Reference			LCD: <i>PilotRef</i>		
Use: This parameter stores the diameter signal of the reel at the time the <i>Pilot Control</i> has been setup (9.10 “Adjustment Procedure”).					
Unit	Parameter Range		Selection	Default	Application
	Min	Max			
N ¹⁾	0.0	100'000.0	-	100.0	B U R L

Pilot Diameter Signal			LCD: <i>Pilot d</i>		
Use: This parameter stores the diameter at the time the <i>Pilot Control</i> has been setup. The value is determined with the adjustment Procedure <i>Pilot control</i> .					
Unit	Parameter Range		Selection	Default	Application
	Min	Max			
V	0.00	10.00	-	0.00	B U R L

Min. Dia. Signal at Holding Torque			LCD: <i>U@TrqMin</i>			
Use: The parameter <i>U@TrqMin</i> is the electrical signal corresponding to the holding torque at minimum reel diameter (see 9.6 “Configuration Parameter Group”, parameter <i>HT d Min</i>).						
Unit	Parameter Range		Selection	Default	Application	
	Min	Max				
V	0.00	10.00	-	0.0	B	U R L

Max. Dia. Signal at Holding Torque			LCD: <i>U@TrqMax</i>			
Use: The parameter <i>U@TrqMax</i> is the electrical signal corresponding to the holding torque at minimum reel diameter (see 9.6 “Configuration Parameter Group”, parameter <i>HT d Max</i>).						
Unit	Parameter Range		Selection	Default	Application	
	Min	Max				
V	0.00	10.00	-	0.0	B	U R L

9.17 Reset to Default Parameters

Factory settings of your CMGZ309 tension controller can be re-established either over the parameter setting menu (see 9.15 “Description System Parameters”) or by holding the two keys  and  at the same time while the controller is powered on.

9.18 Complete Parameter List

PID Parameter Group						
Parameter	LCD	Unit	Min	Max	Selection	Default
Controller Configuration	PID Conf	-	-	-	PI PID	PI
PID set in use	SetinUse	-	-	-	1 2	1
Proportional P1	PID P1	-	0.001	30.000	-	0.100
Integral I1	PID I1	s	0.001	30.000	-	0.100
Differential D1	PID D1	s	0.0000	3.0000	-	0.0000
Proportional P2	PID P2	-	0.001	30.000	-	0.100
Integral I2	PID I2	s	0.001	30.000	-	0.100
Differential D2	PID D2	s	0.0000	3.000	-	0.0000

Function Parameter Group						
Parameter	LCD	Unit	Min	Max	Selection	Default
Control Mode	CtrMode	-	-	-	UnwBrake UnwDrive RewDrive LineDrive	UnwBrake
Torque in Use	Torque	-	-	-	Yes No	No
Pilot Control	PilotCtr	-	-	-	Yes No	No
Taper Function	TaperFct	-	-	-	Yes No	No
Position Line Drive	PosLnDrv	-	-	-	Ahead After	Ahead
Speed Overlay	V Overlay	-	-	-	Yes No	No

Configuration Parameter Group						
Parameter	LCD	Unit	Min	Max	Selection	Default
PID Influence	PIDInflu	%	0.1	100.0	-	100.0
Holding Torque at maximum diameter	HT d Max	%	0.0	100.0	-	0.0
Holding Torque at minimum diameter	HT d Min	%	0.0	100.0	-	0.0
Start time	t Start	s	0.0	100.0	-	0.0
Start speed	v Start	%	0.00	100.00	-	0.00
Start limit	StartLim	%	0.0	100.0	-	0.0
Brake time	t Brake	s	0.0	100.0	-	0.0
Brake booster	Booster	%	0	300	-	0
Feedback value range	FBRange	%	1.0	100.0	-	100.0
Ramp diameter	d Ramp	s	0.1	60.0	-	1.0
Ramp reference	RampRef	s	0.1	20.0	-	1.0
Scale of reference input	ScaleRef	N ¹⁾	0.0	100'000. 0	-	1000.0
Ratio of guiding (taper?) value	Ratio	-	0.010	20.000	-	1.000
Min. diameter of Taper function	MinTaper	mm	0.1	5000.0	-	100.0
Max. diameter of Taper function	MaxTaper	mm	0.1	5000.0	-	1000.0
Reference value at 25% of max. dia.	Ref25%d	%	1	1000	-	100
Reference value at 50% of max. dia.	Ref50%d	%	1	1000	-	100
Reference value at 75% of max. dia.	Ref75%d	%	1	1000	-	100
Reference value at 100% of max. dia.	Ref100%d	%	1	1000	-	100

1) The display shows the unit of measure that was previously selected

Amplifier Parameter Group						
Parameter	LCD	Unit	Min	Max	Selection	Default
Offset	Offset	Digit	-8000	+8000	-	0
Gain of amplifier	Gain	-	0.100	20.000	-	1.000
System force	SysForce	N ¹⁾	1.0	100'000.0	-	1000.0
Filter cut-off freq.	Filter	Hz	0.1	200.0	-	10.0
Tension at 10V output	Tens@10V	N ¹⁾	1.0	100'000.0	-	1'000.0

1) The display shows the unit of measure that was previously selected

Adjustment Procedures		
Procedure	LCD	Description
Offset compensation	Offset	With the Offset compensation you can compensate the roller weight. It is always performed before the calibration. The calculated value is stored in the parameter <i>Offset</i> (9.8 "Amplifier Parameter Group").
Calibration	Calibration	The Calibrating procedure adjusts the controller and load cells and calculates the gain so that the display gives you the actual tension value. The determined values are stored in the parameters <i>Gain</i> and <i>SysForce</i> (9.8 "Amplifier Parameter Group").
Diameter adjustment for taper function	Diameter	This procedure carries out a diameter adjustment for the taper function. It measures via the diameter sensor the voltage of the reel diameters and stores them in the parameters <i>U@d1</i> and <i>U@d2</i> (9.17 "Service Parameter Group").
Pilot control adjustment	Pilot control	This adjustment procedure allows the setup and tuning of a pilot control. The calculate parameters are stored in <i>PilotCtr</i> , <i>PilotRef</i> and <i>Pilot d</i> (9.17 "Service Parameter Group").

Input / Output Parameter Group						
Parameter	LCD	Unit	Min	Max	Selection	Default
Digital Input 1 Digital Input 2	Input 1 Input 2	-	-	-	Levl→Ctr Edge→Ctr Disabled SelecPID EmerStop Levl→BRe Edge→BRe	Input 1= Disabled Input 2= Disabled
Reference Source	RefSourc	-	-	-	Internal External	Internal
Output Mode Selection	Out Mode	-	-	-	0..10V 0..20mA 4..20mA +/- 10V	0..10V
Relay Output 1 Relay Output 2	Relay 1 Relay 2	-	-	-	Limit 1 ⁶⁾ Limit 2 ⁶⁾ CtrError ⁶⁾ Ctr ON ⁶⁾ Disabled ⁶⁾	Relay 1= Limit 1 Relay 2= CtrError
Limit Con. Relay 1 Limit Con. Relay 2	LimCond1 LimCond2	-	-	-	< Limit > Limit	LimCon1= < Limit LimCon2= > Limit
Limit Value 1 Limit Value 2	Limit 1 Limit 2	N ¹⁾	0.1	100'00 0.0	-	L1= 100.0 L2= 1000.0
Control Error	CtrError	%	1.0	100.0	-	10.0
Max. Brake Current	Brake	A	-	-	0.125 0.25 0.5 1 2	0.125
Signal of Diameter Sensor.	d Signa	-	-	-	Proporti ReciProp	Proporti

1) The display shows the unit of measure that was previously selected

6) These selections can only be assigned to a relay once. If the scan criterion is already assigned to a relay, it won't be available for the other relay and it won't be displayed. The selection *Disabled* can be assigned to both relays.

System Parameter Group						
Parameter	LCD	Unit	Min	Max	Selection	Default
Password	Password	-	-	-	Yes No	No
Language	Language	-	-	-	English German	English
Unit of Measure	Unit	-	-	-	N kN g kg lb ⁷⁾	N
Display Filter	Dis.Filt	Hz	0.1	10.0	-	1.0
Ethernet IP Address	IP Addr.	-	000.00 0.	255.255. 255.255	-	192.168. 000.090
Subnet Mask Address	Subnet	-	000.00 0.	255.255. 255.255	-	255.255. 255.000
LAN Speed	LANSpeed	MBPS			10 100	100
Default Settings	Default	-	-	-	Not set Yes	Not set

⁷⁾ By changing to *lb* (pounds) the whole unit system will change from metric to imperial units.

Service Parameter Group						
Parameter	LCD	Unit	Min	Max	Selection	Default
Output	Output	%	0	100	-	0
Reference 1 Reference 2	Ref 1 Ref 2	N ¹⁾	0.0	100'000. 0	-	100.0
Reel Diameter 1 Reel Diameter 2	d1 Value d2 Value	mm	1	5000	-	1000
Reel Dia. Signal 1 Reel Dia. Signal 2	U@d1 U@d2	V	0.00	10.00	-	10.0
Pilot Control	PilotCtr	%	0.0	100.0	-	0.00
Pilot Reference	PilotRef	N ¹⁾	0.0	100'000. 0	-	0.0
Pilot Dia. Signal	Pilot d	V	0.00	10.00	-	0.0
Min. Dia. Signal at Holding Torque	U@TrqMin	V	0.00	10.00	-	0.0
Max. Dia. Signal at Holding Torque	U@TrqMax	V	0.00	10.00	-	0.0

¹⁾ The display shows the unit of measure that was previously selected

10 Determination of the Control Parameters

10.1 Experimental Determination of the Control Parameters (recommended):

If the behaviour of the control loop is unknown, tuning is done by means of a systematic approach (see Fig. 30):

- Set parameter *Derivative D* to 0s (only if PID configuration is used)
- Set parameter *Integral I* very high (32.675s)
- Set parameter *Proportional P* very low (e.g. 0.010)
- Enable controller (ref. to 10.5 "Automatic Operation")
- If control loop is not oscillating: Increase *Proportional P*
- If control loop is oscillating: decrease *Proportional P*
- Repeat this procedure until the control loop is stable and nearly oscillating. The controller can remain enabled; the controller parameters may be changed during automatic operation.
- If the control loop is running stable with the P-component, the *Integral I* can be decreased until the steady error disappears.
- If the *Integral I* is too small, the control loop will become unstable again.
- (Only using PID configuration): Increase *Derivative D* carefully until the controller is nearly oscillating.
- If the *Derivative D* is too high, the control loop will become unstable again.
- If the control loop is running stable, the parameters *Proportional P*, *Integral I* and *Derivative D* should be noted for setup at a possible re-installation.

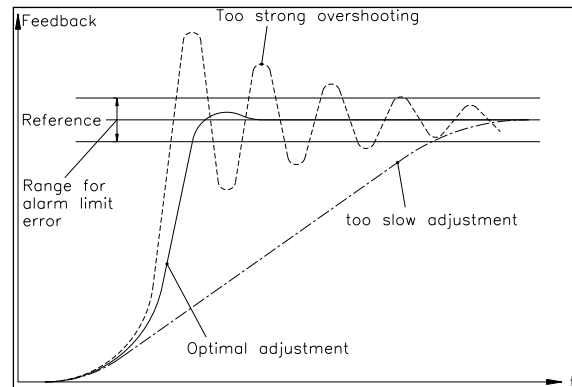

Fig. 30: Transient effect of the control system C431013e

10.2 Mathematic Determination of the Control Parameters

- If the behaviour of the control loop is known, the control parameters can be calculated by the described mathematic procedure and saved in the parameters *Proportional P1...P2*, *Integral I1...I2* and *Derivative D1...D2*. Only the parameter set that was selected is active (ref. to 10.3 "Switching the Control Parameters".)
- If the control loop is oscillating, the control parameters will be fine-tuned as described under „Experimental determination of control parameters“.

**Note**

A correct setting of the control loop can be time consuming. We recommend using an oscilloscope to better judge the adjustment of the control parameters and record the behaviour of the feedback value. The oscilloscope shows whether the control loop operates stable and the static error is compensated.

**Note**

The controller must be adjusted so that the feedback reaches the reference in the shortest possible time but without overshooting. You can see if the feedback overshoots either on the display or on the oscilloscope

**Note**

Original PID control parameters determined during the test run, during the setup of pilot control or after increasing material tension may be no longer suitable for stable operation. FMS recommends re-adjusting the control parameters at any change of operation condition until the machine runs stable.

**Note**

The start and stop sequence of a machine requires higher standards to any control loop. Stable operation during these phases can only be achieved by optimising the control loop, in particular their starting and stopping behaviour. It is not enough to have a stable control loop at normal operating conditions. For more details refer to chapter "8.1 Experimental Determination of the Control Parameters").

10.3 Switching the Control Parameters

Two individual PID parameter sets and two reference values ($P1...P2$; $I1...I2$; $D1...D2$; and $Ref\ 1...Ref\ 2$) can be saved in the parameter list. $Ref\ 1$ is assigned to PID-set 1 and $Ref\ 2$ to PID-set 2. The user can toggle between the two parameter sets allowing an easy and flexible adjustment of the controller to different materials. Switching from one parameter set to the other can be done in two different ways:

1. Via Digital Inputs (ref. to 4.7 "Digital Inputs")
2. Via the operation panel (see Fig.17 and 18) going through the Parametrisation State (ref. to 9.2 "PID Parameter Group")

If the PID parameter selection was assigned to a digital input, the change via operation panel is not possible anymore.

10.4 Manual Operation

In Manual Operation the Output Value can be changed and it can be sent via the analogue output to the break/drive for fine tuning purposes in the machine.

Proceeding:

3. Go to the Parametrisation State.

4. Scroll the menu with the  key until reaching Service Parameter Group.

5. Press  to enter Parameter Selection.

6. The Display shows:

Manual
Operatio

7. Press  to enter the Output value changing mode. The previously stored Output value will be applied to the output.

8. Press  again. The display shows

Output

 and starts flashing.

9. Change the Output value with the   keys. The changes will be applied simultaneously to the output.

10. Confirm the change with the  key.

11. Manual Operation can now be aborted by pressing three times . The controller returns to Automatic Operation (Idle State).



At the first call the Output value will be 0. After the change the value acts on the analogue output as long as you remain in Manual Operation. After leaving Manual Operation the value will be stored in the parameter *Output* and it will be used as a starting value the next time you enter Manual Operation.

10.5 Automatic Operation

State „Controller Disabled“

After power on, the controller is in the Idle State. Its output value is 0V (or 0mA / 4mA) depending on the setting of parameter *Out Mode*. When operating a brake, the output value is 0V or refers to the parameter *Torque*.

Enable Controller

The control mode can either be enabled via a Digital Input or manually by pressing the  key on the front panel as long as the function is not assigned to a Digital Input. If the Enable Control function is assigned to any Digital Input, the  key will be disabled.

The LED above the  key will light indicating that the controller is brought to the Enable State (see Fig.17 and Fig. 18). The controller will now adjust the material tension matching the reference value.

When operating a drive, the controller begins to tighten the material with the speed given by parameter Start Speed v_{Start} until an initial material tension in the parameter Start Limit $StartLim$ is reached. During this process the roller might turn a short distance in the opposite rolling direction. Afterwards the material tension is increased to the reference value or the pilot control value depending on parameter Pilot Control $PilotCtr$. When operating a brake, the controller starts from the „Holding torque“ and drives to the reference value or the pilot control value (depending on parameter $PilotCtr$).

Change of control parameters while automatic operation



The control parameters $P1...P2 / I1...I2 / D1...D2$ can be changed while the controller is in the Enable State. Setting is done as described in „9.2 PID Parameter Group“ and Fig. 20 “State Diagram PID Parameter Group”.

Change of Reference Value while in Automatic Operation

The reference value can be changed while in automatic operation as described in 8.3 “Setting the Reference Value”.

Disable controller

Controller mode has to be disabled to terminate the controlling process after stopping the machine. If the enabling instruction was given via digital inputs, disabling must also be done the same way. After disabling controller mode, the output value will immediately be reset to zero. If a brake is operated and the parameter $Torque$ is set to yes, the output value will be reset to the value stored in parameter $HT d Max$

The LED over the  key switches on and the one over the  key goes off (see Fig. 17 and 18)



Caution

If the controller is disabled while the material is running, the drive unit will stop immediately. This might cause material cracks. Therefore, the controller should be disabled only if the machine is no longer running.

10.6 Additional Settings

PI or PID configuration

The Tension Controller can be operated as a PI or as a PID controller (with unwind brake as PI only). FMS recommends choosing the PI configuration since it is much easier to handle the device and controller dynamics are good enough for most applications:

Characteristics of PI controller	Characteristics of PID controller
<ul style="list-style-type: none"> + Easier to adjust than a PID controller + Quite good behaviour + Is very suitable where great inertia moments make the D component ineffective 	<ul style="list-style-type: none"> + Behaviour covers higher dynamic than a PI controller. PID controlling is used where the dynamics of a PI controller is not good enough. - The D component increases the tendency for instability compared with a PI controller!

Setting of the Lowpass Filters

The electronic unit contains two lowpass filters that are independently adjustable. One filter is for the feedback signal and the other for the display refresh rate. Signal variations that are faster than the cut-off frequency of the filter will be suppressed. The lower the cut-off frequency is set, the more sluggish the output signal will be. The lowpass filters are configured by setting the cut-off frequency to an appropriate value. The cut-off frequency is set in the **9.8** "Amplifier Parameter Group" for the feedback signal filter and in the **9.14** "System Parameter Group" for the display filter.



Note

If the cut-off frequency is set too low, the output signal will become sluggish. It could happen that the feedback value is no longer suitable for control loop applications. You have to pay attention to the cut-off frequency that is set to a suitable value.

Setting of the Limit Switches

The electronic unit provides two limit switches which can be tapped to the Relay Outputs. The limit switches are actuated when the feedback value exceeds the stored threshold values. The Limit Value settings are performed in the **9.12** "I/O Parameter Group". For details refer also to **chapter 9.13** "Description of Input / Output Parameters".

11 Setup of an Unwind Brake Controller

11.1 Configuring the Basic Parameters

For an unwind brake controller (see Fig.3 top left diagram) the parameters seen in the table below must be set:

Unwind Brake Application		
Parameter Group	Parameter	Setting
Function	<i>CtrMode</i>	<i>UnwBrake</i> (default)
Function	<i>PilotCtr</i>	For the time being set to <i>No</i>
Input / Output	<i>Out Mode</i>	0...10V or according to the brake used
Configuration	<i>d Ramp</i>	Reset to default = 1.0 s
Configuration	<i>RampRef</i>	Reset to default = 1.0 s
Input / Output	<i>RefSourc</i>	According to machine configuration (<i>internal</i> or <i>external</i>)
Configuration	<i>ScaleRef</i>	Only if reference potentiometer is used
Function	<i>Torque</i>	For the time being set to <i>No</i>
Configuration	<i>HT d Max</i>	For the time being set to 0%, or according to your requirements (see chapter 11.2)
Configuration	<i>StartLim</i>	For the time being set to 0.0%
Configuration	<i>t Start</i>	For the time being set to 0.0s
Configuration	<i>t Brake</i>	For the time being set to 0.0s
Configuration	<i>Booster</i>	For the time being set to 0.0%

11.2 Entering the Holding Torque

The unwind reel can be held by the brake at standstill while the machine is stopped. If the parameter *Torque* is set to “No”, the output will show the holding torque but only if the controller is enabled. If the parameter *Torque* is set to “Yes”, the output will show the holding torque also if the controller is disabled.

Parameter *PilotCtr* set to “No”:

In the parameter *HT d Max* there is the possibility to enter a holding torque (see **chapter 9.6** “Configuration Parameter Group”) this is e.g. a possibility to prevent spin.

Parameter *PilotCtr* set to “Yes”:

Dependent on the diameter a holding torque is output which is proportional to the actual diameter. A prerequisite for that is that a diameter signal is available. The holding torque (which is proportional to the diameter) is tuned with the parameters *HT d Max* and *HT d Min*. While storing the values for *HT d Max* and *HT d Min* the actual diameter signals (as a voltage signal) are simultaneously stored in the Service Parameter Group. The corresponding parameters are called *U@TrqMin* and *U@TrqMax* and can be accessed there.

11.3 Enter Start Limit

After controlling is enabled, the output is 0V or equal to the holding torque. During the start time the output will increase linearly towards the maximum (10V) as long as the start limit value is not reached.

The *StartLim* value is entered as a percentage of the actual reference value. After the synchronization, when the feedback value reaches the *StartLim* value, the PID controller takes over.

11.4 Enter the Start Time

After controlling is enabled, the output is 0V or equal to the holding torque. During the time specified in the parameter *t Start*, the output value will increase linearly towards the maximum (10V) as long as the value specified in *t Start* is not reached. The Start Time is defined in seconds. A longer Start Time results in a slower rise time of the output value. A shorter Start Time results in a faster rise time of the output value.

11.5 Enter Brake Time

When the controller is disabled the output value will go to the last output value multiplied by the value specified in the parameter *Booster*. This value will be kept for the time specified in the parameter *t Brake*. The Brake Time value is defined in seconds. Did the Brake Time run out, the output value will be set to 0 or equal to holding torque.

11.6 Enter Brake Booster

When the controller is disabled the output value will go the last output value multiplied by the value specified in the parameter *Booster*. This value will be kept for the time specified in the parameter *t Brake*. The *Booster* value is specified in percentage of the output value before the controller is disabled. If the time specified in the parameter Brake Time did run out the output value will be 0 V or equal to the holding torque

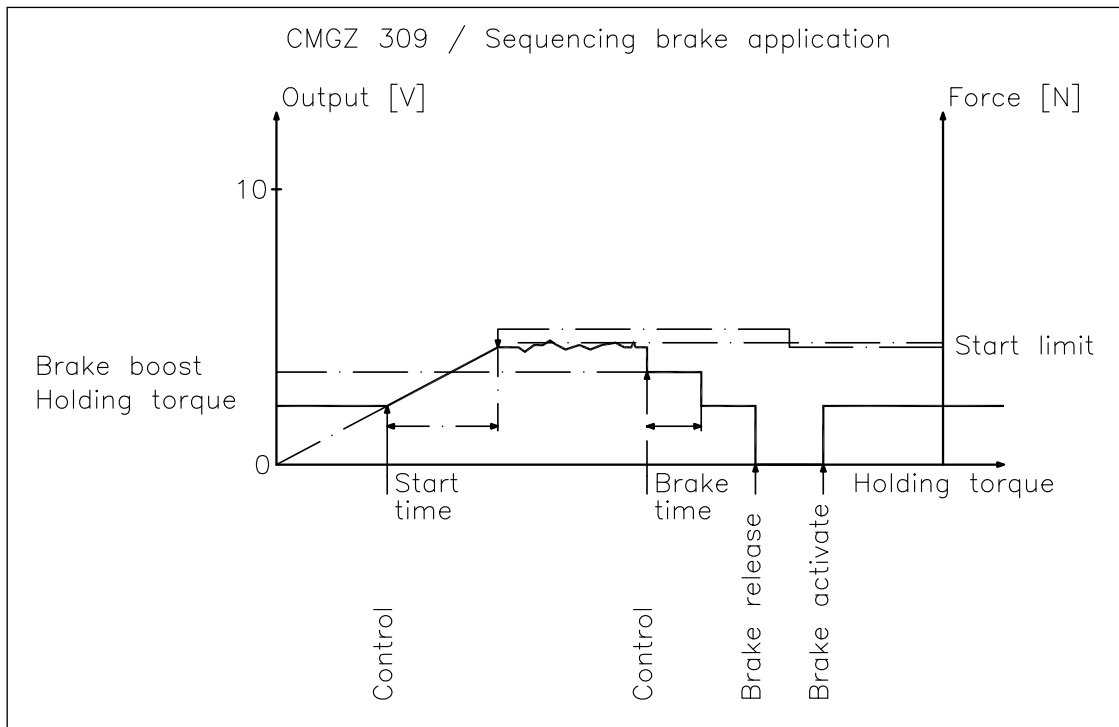

Fig. 31: Sequence brake application control

C309025e

11.7 Setup of Pilot Control

Pilot control enables the evaluation of the actual reel diameter. This allows the calculation of the brake torque or the drive power appropriate to the given reel diameter (pilot control signal). In addition, the PID control parameters are dynamically adapted to the reel diameter. Thus the controller has only to handle the tension variations. This increases control loop stability.



Note

For winder operations, the pilot control must work in combination with a torque controlled drive. A speed controlled drive does not bring satisfactory results with pilot control. This note doesn't apply if a brake is operated.

Transmission of Diameter Signal

To transmit the actual reel diameter to the electronic unit, an analogue signal 0...10V (from a distance sensor or other source) is fed to the analogue input (terminals *Signal 0...10V (terminal 29)* and *Signal Gnd (terminal 30)*). Refer to **Fig. 4: Wiring diagram CMGZ309**.

Diameter Adjustment

Diameter adjustment is not mandatory for using the pilot control function. The only requirement is to set the diameter sensor behaviour correctly. The diameter sensor can either provide a proportional or reciprocally proportional signal. The behaviour is proportional, if the signal grows faster than the diameter increases. The characteristic can be configured with parameter *d Signa* in the I/O parameter group. Instead of configuring the parameter itself it is also possible to call the diameter adjustment procedure.

Adjustment of Pilot Control

In order the electronic unit to calculating the pilot control correctly, the torque value has to be assigned to the correspondent diameter:

- Set parameter *PilotCtrl* to *No*.
- Proceed for a test run. If with a large diameter the control loop runs stable, the

actual reference value and, after pressing the  key, the actual output value can be read from the display. Note these values on a piece of paper:

Actual reference value	REF	=	_____	[N, lbs]
Actual output value	OUTPUT	=	_____	[V, mA]

- Terminate test run
- Calculate the required torque value as a percentage of the maximum output signal which is 10V or 20mA:

$$\% \text{-torque} = \frac{\text{actual output}}{\text{max. output}} \cdot 100 = \text{_____} [\%]$$

The torque for the pilot control is now determined.

- Set parameter *Pilot control* to *Yes*.
- The reel diameter must be the same as during the test run.
- In the parameter group **Adjustment Procedures** select the procedure *PilotCtrl*. Follow the instruction in **Fig. 32: State Diagram Adjustment Procedure Pilot Control**.

Enter the previously calculated torque in [%] confirm with  key.

Enter the previously noted reference in [N] and confirmation with  key.

The controller having calculated the pilot Control Values the LCD reads

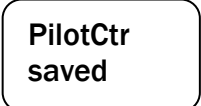

- The calculated pilot control values will be stored in the parameters *PilotCtrl*, *PilotRef* and *Pilot d* in the Service Parameter Group.

12 Setup of an Unwind Drive Controller

12.1 Configuring the Basic Parameters

For an unwind drive controller (see Fig. 3 middle left diagram) the following parameters must be set according to your application:

Unwind Drive Application		
Parameter Group	Parameter	Setting
Function	<i>CtrMode</i>	Change to <i>UnwDrive</i>
Function	<i>PilotCtr</i>	For the time being set to <i>No</i>
PID	<i>PID conf</i>	For the time being set to <i>PI</i> ; if <i>PID</i> is required, refer to 10.6 "Additional Settings"
Input / Output	<i>Out Mode</i>	$\pm 10V$ or according to the drive used
Configuration	<i>d Ramp</i>	Reset to default = 1.0 s
Configuration	<i>RampRef</i>	Reset to default = 1.0 s
Input / Output	<i>RefSourc</i>	According to machine configuration (<i>internal</i> or <i>external</i>)
Configuration	<i>ScaleRef</i>	Only if reference potentiometer is used.
Configuration	<i>v Start</i>	For the time being set to 0.00%
Configuration	<i>StartLim</i>	For the time being set to 0.0%

Continue now with chapter 8.3 "Setting the Reference Value". If the general setup is done, add the special features below according to your requirements.

12.2 Automatic Start Function for a Unwind Drive Configuration

With the integrated automatic start function, it is possible to start the controlling process in a gentle way even if the material has some slack. The controller operates with slow initial speed until a certain minimum tension is reached. After reaching the minimum tension, controlling will be fully activated.

To enable the automatic start function, the parameters *v Start* and *StartLim* are set to appropriate values (ref. to 9.6 "Configuration Parameter Group").

12.3 Pilot Control in an Unwind Drive Configuration

As previously described the pilot control enables to evaluate the actual reel diameter and adapt the control parameters dynamically in the process. This will increase considerably the control loop stability. Setup of pilot control is described in chapter 11.7 "Setup of Pilot Control".

13 Setup of a Rewind Drive Controller

13.1 Configuring the Basic Parameters

Following parameters must be set for a winding drive controller (see Fig. 3 middle right diagram) according to the used application:

Rewind Drive Application		
Parameter Group	Parameter	Setting
Function	<i>CtrMode</i>	Change to <i>RewDrive</i>
Function	<i>PilotCtr</i>	For the time being set to <i>No</i>
PID	<i>PID conf</i>	For the time being set to <i>PI</i> ; if <i>PID</i> is required, refer to 10.6 "Additional Settings"
Input / Output	<i>Out Mode</i>	$\pm 10V$ or according to the drive used
Configuration	<i>d Ramp</i>	Reset to default = 1.0 s
Configuration	<i>RampRef</i>	Reset to default = 1.0 s
Input / Output	<i>RefSourc</i>	According to machine configuration (<i>internal</i> or <i>external</i>)
Configuration	<i>ScaleRef</i>	Only if reference potentiometer is used.
Configuration	<i>v Start</i>	For the time being set to 0.00%
Configuration	<i>StartLim</i>	For the time being set to 0.0%

Continue now with section 8.3 "Setting the Reference Value". If the general setup is done, add the special features below according to your requirements.

13.2 Automatic Start Function for a Rewind Drive Configuration

With the integrated automatic start function, it is possible to start the controlling process in a gentle way even if the material has some slack. The controller operates with slow initial speed until a certain minimum tension is reached. After reaching the minimum tension, controlling will be fully activated.

To enable the automatic start function, the parameters *v Start* and *StartLim* are set to appropriate values (ref. to 9.6 "Configuration Parameter Group").

13.3 Setup of Pilot Control for a Rewind Drive Configuration

As previously described the pilot control enables to evaluate the actual reel diameter and adapt the PID control parameters dynamically in the process. This will increase considerably the control loop stability. Setup of pilot control is described in chapter 11.7 "Setup of Pilot Control".

13.4 Diameter Adjustment

To provide the electronic unit with the actual reel diameter information, distance signal and diameter range must be assigned to each other. This is done in the following way:

- Insert reel with a small diameter, so that the distance sensor delivers a small diameter signal, or set PLC diameter signal to a small value.
- In the parameter group *Adjustment Procedures* select the procedure *Diameter*. Follow the instruction in Fig. 25: "State Diagram Adjustment Procedures".

- Enter the small reel diameter as *First Diameter*. After confirmation with  the diameter is saved as *d1 Value* together with the corresponding voltage signal as *U@d1* in Service Parameter Group.
- Insert a reel with a large diameter, so that the distance sensor delivers a larger diameter signal, or set PLC diameter signal to a larger value.
- Enter the actual (large) reel diameter as *Second Diameter* as described above.

After confirmation with the  key diameter is saved as *d2 Value* together with the corresponding voltage signal as *U@d2* in Service Parameter Group.

13.5 Taper Function

To cope with the unequal tensions requirements of an empty or full reel, a so called Taper Function can be introduced in the control loop. The Taper Function must be parametrised and the corresponding values have to be entered in specially prepared parameters for this function. The basic information that has to be entered in the controller concern the reel dimensions and its change during the un- or rewinding process (see Fig. 33). The taper function must be activated in the 9.4 “Function Parameter Group” with the parameter *TaperFct* set to “yes”. Only then the respective parameters will appear in the parametrisation menu. These parameters (*MinTaper*, *MaxTaper*, *Ref25%d*, *Ref50%d*, *Ref75%d*, *Ref100%d*) are then stored in the 9.6 “Configuration Parameter Group”.

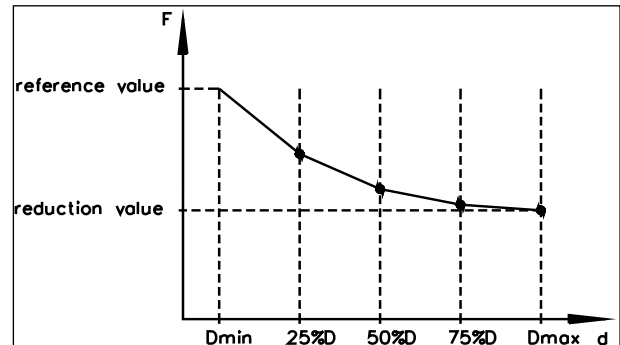







Fig. 33: Parametrisation of taper function

Transmission of Diameter Signal

To transmit the actual reel diameter to the controller, an analogue signal 0...10V (coming e.g. from an external controller or a distance sensor) is fed to the analogue input (see Fig. 4: Wiring diagram CMGZ309). The respective terminals are *Signal 0...10V* (29) and *Signal Gnd* (30).

- In the parameter group Adjustment Procedures select the procedure *Diameter*. Follow the instruction in Fig. 25: State Diagram Adjustment Procedure “Diameter”.
- Enter the first diameter and confirm with  key.
- Go to second diameter with the  key.
- Enter the second diameter and confirm with  key.
- The system will confirm that the diameter voltage values were stored in the parameters *U@d1* and *U@d2* in the Service Parameter Group.
- Leave the procedure with   keys.

Configuring the Taper Function

Set the parameters *Ref25%d*, *Ref50%d*, *Ref75%d* and *Ref100%d* in the chapter 9.6 „Configurations-Parameter List“ such that it results in the desired taper function curve (see Fig. 33).

14 Setup of a Line Drive Controller

14.1 Configuring the Basic Parameters

For a line drive controller (see Fig. 3 bottom) the following parameters must be set according to your application:

Line Drive Application		
Parameter Group	Parameter	Setting
Function	<i>CtrMode</i>	Change to <i>LinDrive</i>
Function	<i>V Overlay</i>	For the time being set to <i>No</i>
PID	<i>PID conf</i>	For the time being set to <i>PI</i> ; if <i>PID</i> is required, refer to 10.6 "Additional Settings"
Input / Output	<i>Out Mode</i>	$\pm 10V$ or according to the drive used
Function	<i>PosLnDrv</i>	According to machine configuration (before or after sensor)
Configuration	<i>RampRef</i>	Reset to default = 1.0 s
Input / Output	<i>RefSourec</i>	According to machine configuration (<i>internal</i> or <i>external</i>)
Configuration	<i>ScaleRef</i>	Only if reference potentiometer is used.

Continue now with chapter 8.3 "Setting the Reference Value". If the general setup is done, add the special features below according to your requirements.

14.2 Setup of Line Speed Overlay

If the controller operates in line speed overlay mode, a line speed signal is used to generate the output value. The controller gets the speed over the analog input signals on terminal 29. The ratio between the tachometer roller and drive roller is defined by parameter *ratio* under Group Configuration. To this calculated value the percentage quota of the PID controller is overlaid. The sum is the output value. The controller has only to compensate for the tension variations. This will increase control loop stability.

Transmission of the Line Speed Signal

To transmit the actual line speed to the controller, an analogue signal 0...10V (coming e.g. from a tachometer generator or other sources) is fed to the analogue input (see Fig. 4: Wiring diagram CMGZ309). The respective terminals are *Signal 0...10V* (29) and *Signal Gnd* (30).

Partitioning of Speed Overlay and controller output:

- Set parameter *v Overly* to *yes*
- Set parameter *ratio*.
- Set *Influence of PID* to a suitable value e. g. 10%

Carry out a test run. Optimize PID control parameters and parameters of PID influence such that the control works stable under all conditions

15 Parameter Setting via a PC

The CMGZ309.EIP controller can be embedded in an Ethernet network and the parameter setting can be done over this network by means of a web browser (Internet Explorer 7). The devices have a static IP-address that can be set over the operation panel. The IP-address is not automatically received over DHCP. Fig. 35 shows the CMGZ309 configuration in a LAN (Local Area Network).

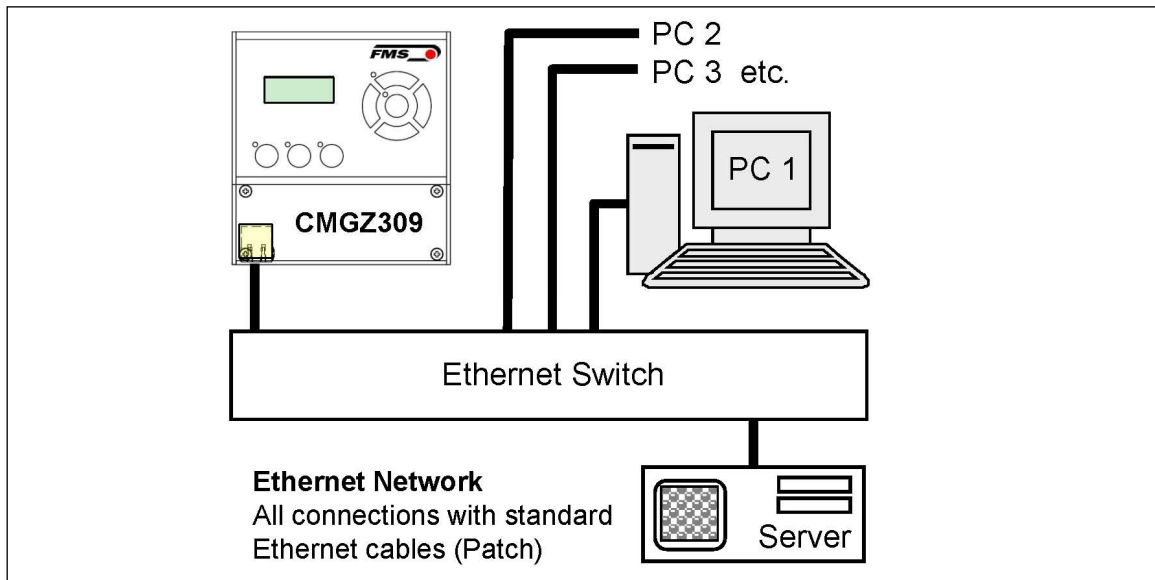

Fig. 35: CMGZ309 embedded in a LAN

C309032e

The parameter setting can also be carried out with a desktop or laptop computer directly connected to the CMGZ309 Controller (see chapter 15.2).

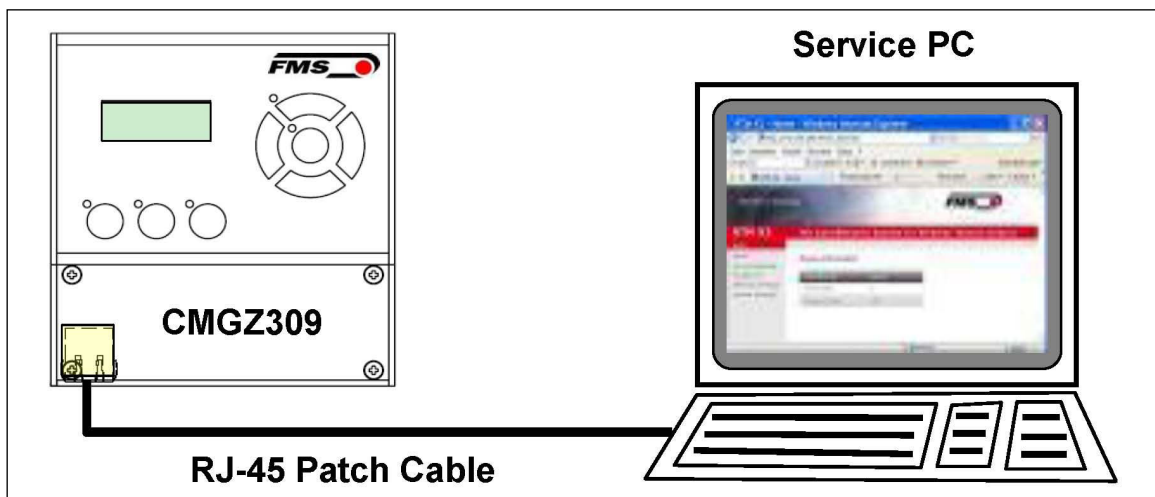

Fig. 36: Direct connection CMGZ309 – PC with a RJ-45 patch cable

C309033e

15.1 Parametrisation via a Web Interface

For the integration of a CMGZ309.EIP controller in your Ethernet network please contact your IT system administrator.

Before the parameterization of the CMGZ309 it must be certain that the CMGZ309 uses an IP address in a static block (not assigned by the server). Once the CMGZ309 was integrated in the network you can address the device with his assigned address e.g. with <http://192.168.000.090> . After establishing the link, the screen Fig. 38 (Homepage) will open up.

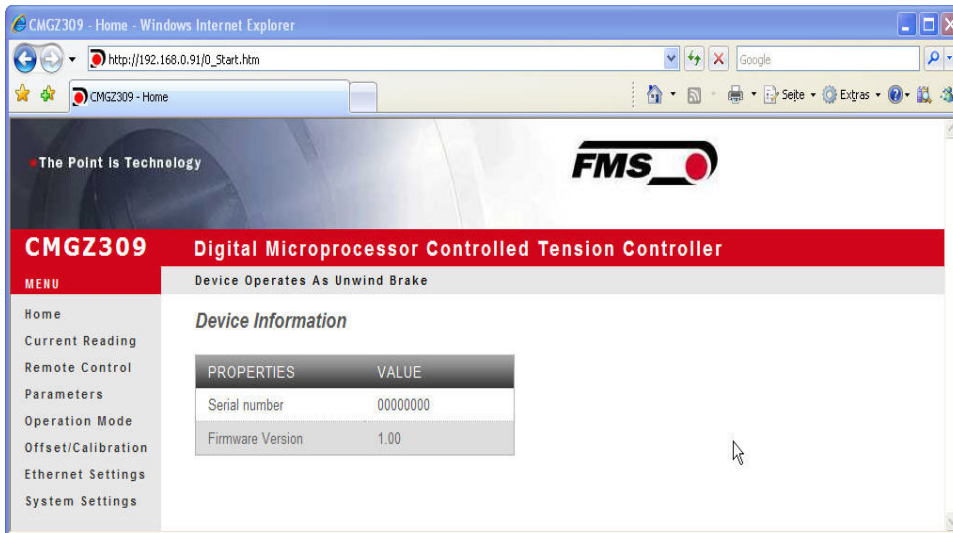

Fig. 38: Homepage with device information

C309050Sse



Note

The CMGZ309 controller can be fully configured and operated via the Ethernet interface. The task bars on the left side of the screen helps to navigate through the menu.

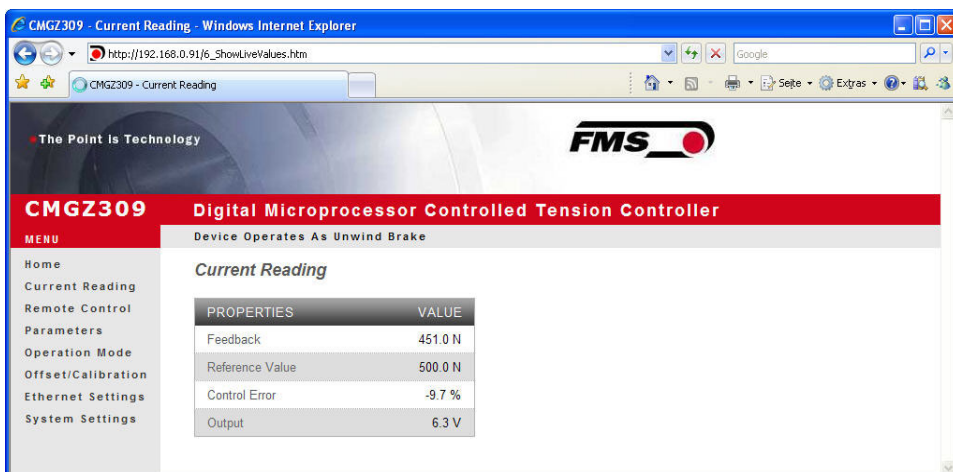

Fig. 39: Current reading of control parameters

C309051Sse

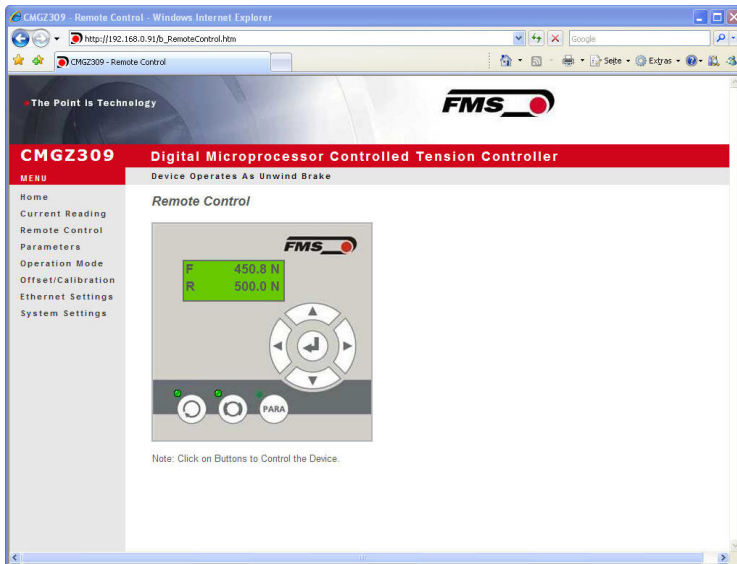

Fig. 40: Operation Panel with remote control function

C309052SSe



Note

A mouse click on the desired key activates the correspondent function.

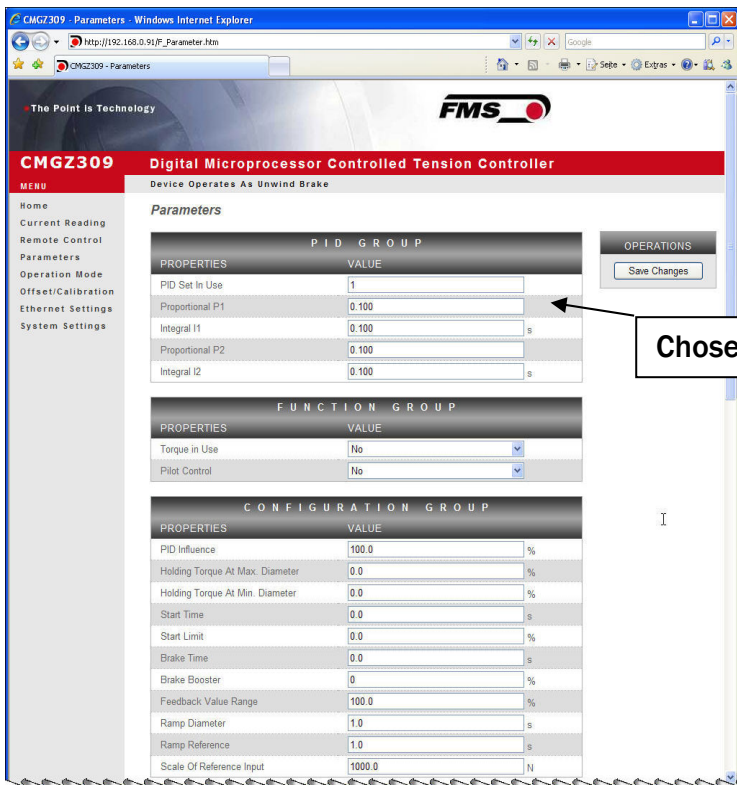

Fig. 41: Parameter List (1st part)

C309053SSe



Note

The parameters can be changes on this screen by overwriting the value. The change can be saved with the button „Save Changes“

AMPLIFIER GROUP		
PROPERTIES	VALUE	
Offset	0	
Gain Of Amplifier	1.000	
System Force	1000.0	N
Filter Cut-Off Frequency	10.0	Hz
Tension At 10V Output	1000.0	N

INPUT / OUTPUT GROUP		
PROPERTIES	VALUE	
Digital Input 1	Disabled	
Digital Input 2	Select PID Set	
Reference Source	Internal	
Output Mode	0..10V	
Relay 1 - Output	Limit 1	
Relay 2 - Output	Control Error	
Limit 1 - Condition	< Limit	
Limit 1 - Value	100.0	N
Limit 2 - Condition	> Limit	
Limit 2 - Value	1000.0	N
Control Error	10.0	%
Max. Brake Current	0.125A	
Signal of Diameter Sensor	Proportional	
Signal of Diameter Sensor	Proportional	

SERVICE GROUP		
PROPERTIES	VALUE	
Output	0	%
Reference 1	500.0	N
Reference 2	100.0	N
Reel Diameter 1	1000	mm
Reel Dia. Signal 1	0.00	V
Reel Diameter 2	1000	mm
Reel Dia. Signal 2	0.00	V
Pilot Control	0.0	%
Pilot Reference	0.0	N
Pilot Dia. Signal	0.00	V
Min. Dia. Signal At Holding Torque	0.00	V
Max. Dia. Signal At Holding Torque	0.00	V

Fig. 42: Parameter List (2nd part).

C309054SSe

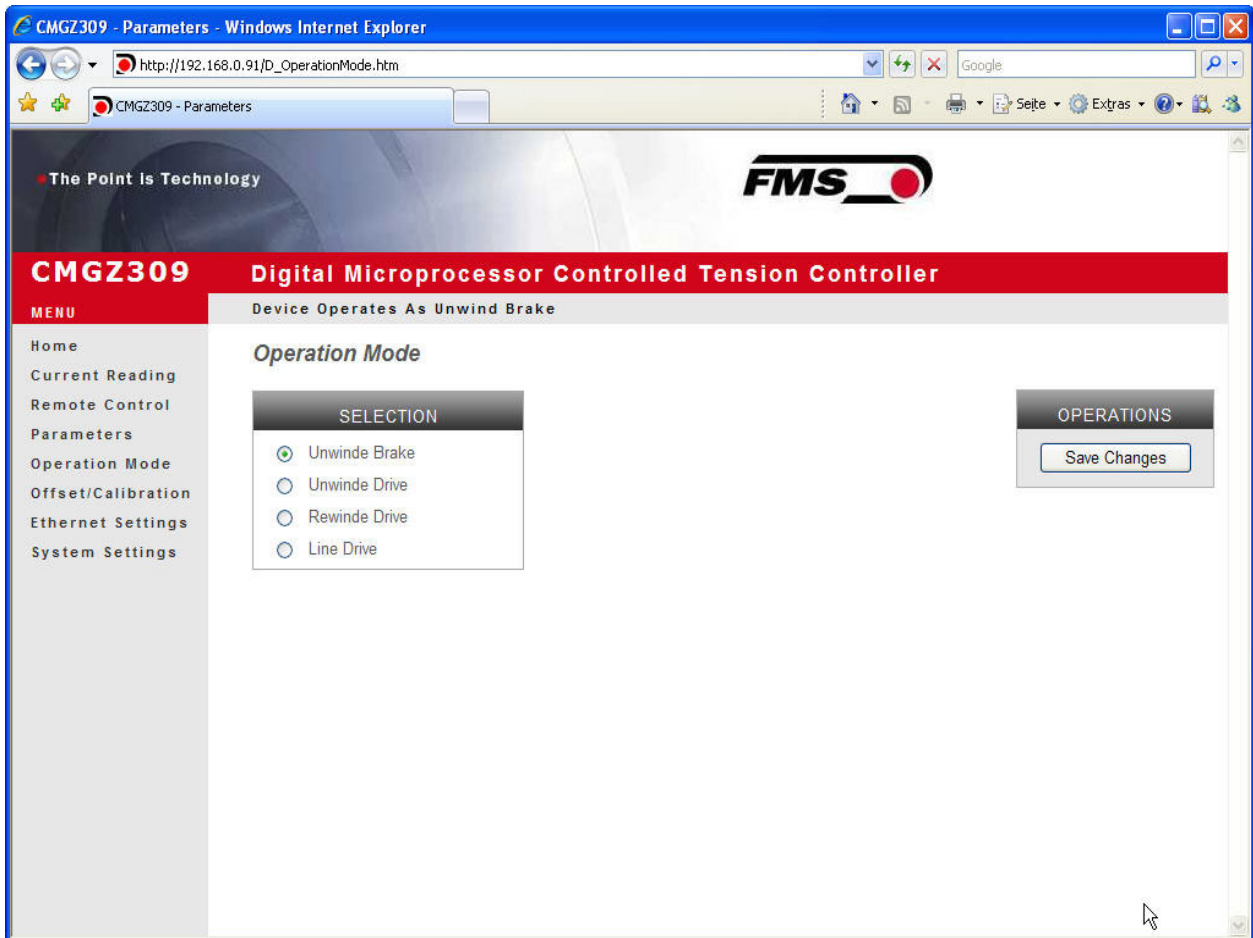

Fig. 43: Operation Mode

C309055e

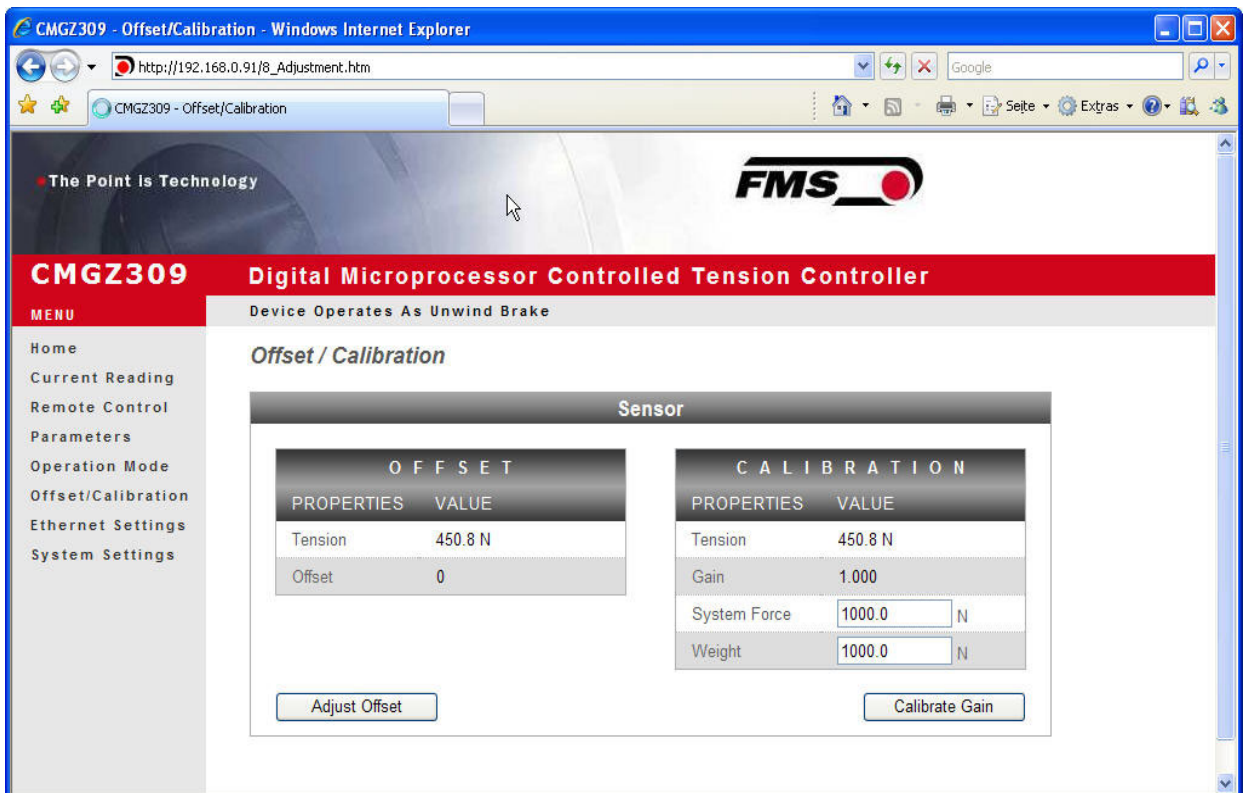

Fig. 44: Offset compensation and calibration over a web browser

C309056e

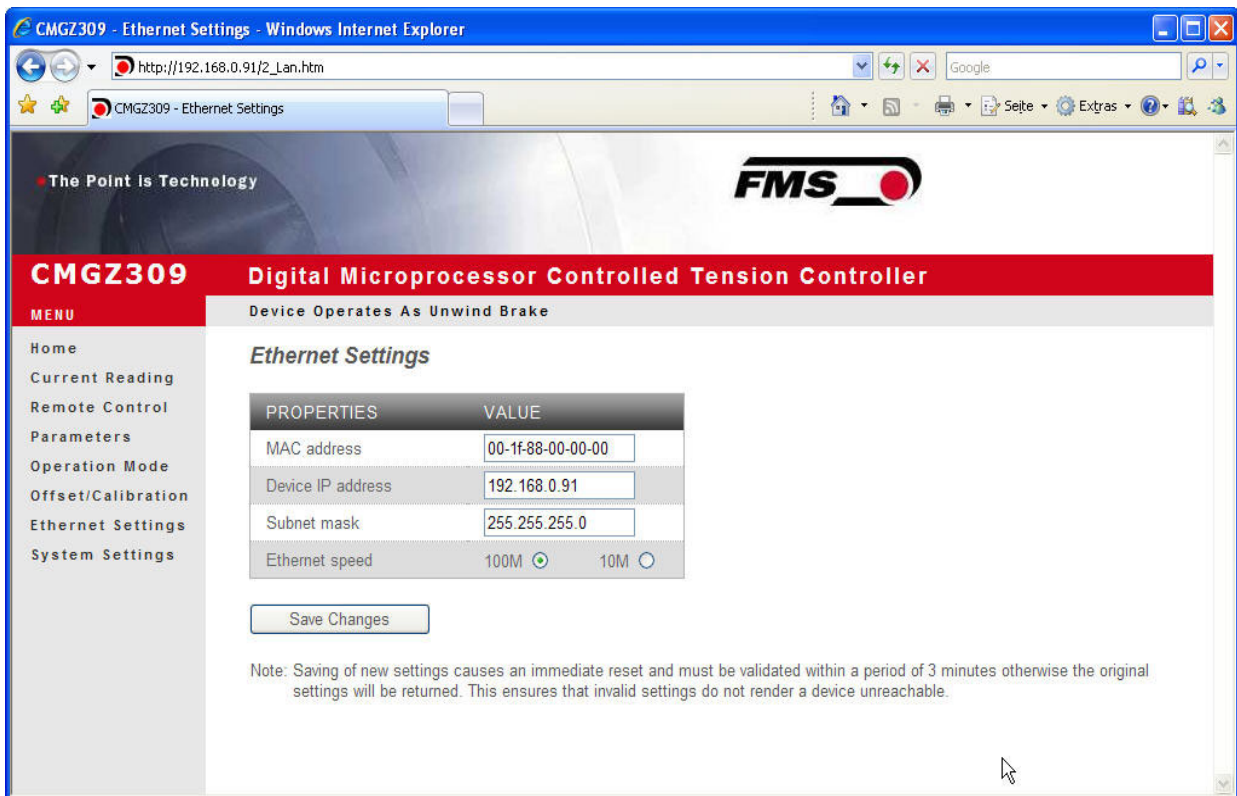

Fig. 45: Ethernet Settings

C309057e

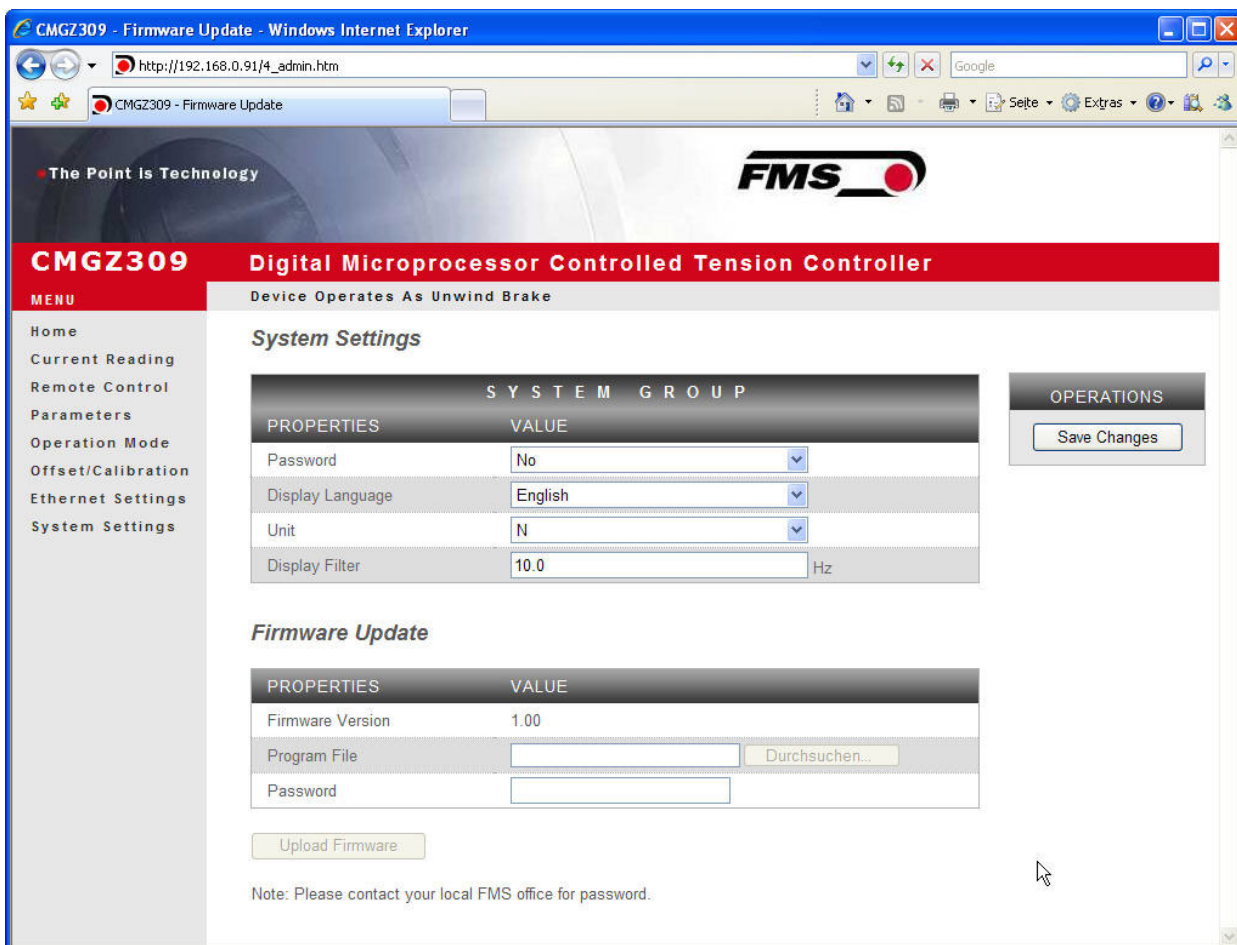

Fig. 46: System Settings

C309058e

15.2 Parameterization via a PC (peer-to-peer connection)

This paragraph describes the procedure for setting up a desktop or laptop computer to communicate with a FMS CMGZ309 controller.

Before connecting the CMGZ309 controller with a “cross-over-cable” directly to a PC, the computer must be configured with a “static” IP address that lets it recognize the CMGZ309. If the CMGZ309 controller is connected to a network by using e.g. a switch, the following procedure is not necessary. To establish the connection between your PC and the CMGZ309 follow the steps below.

Setup for OS Window 7:

1. Connect PC and CMGZ309 Controller with a “RJ-45 patch cable”
2. Power-up PC and CMGZ309 Controller
3. In order to recognize the CMGZ309 System your PC must be configured with a “static” IP-address. Click on the Windows button (lower left-hand corner).
4. Click on Control Panel
5. Double click on Network ... Center.

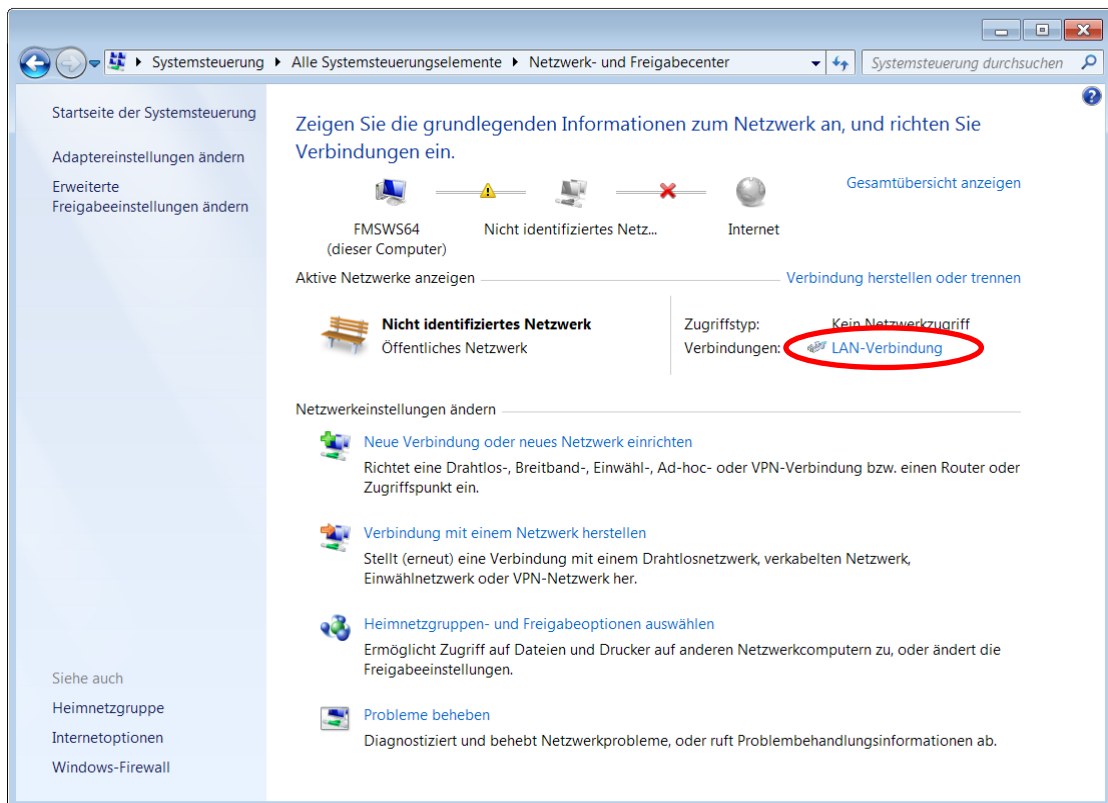

6. Double click on “Local Area Network”. The dialog box “Status of LAN connection” will open up.

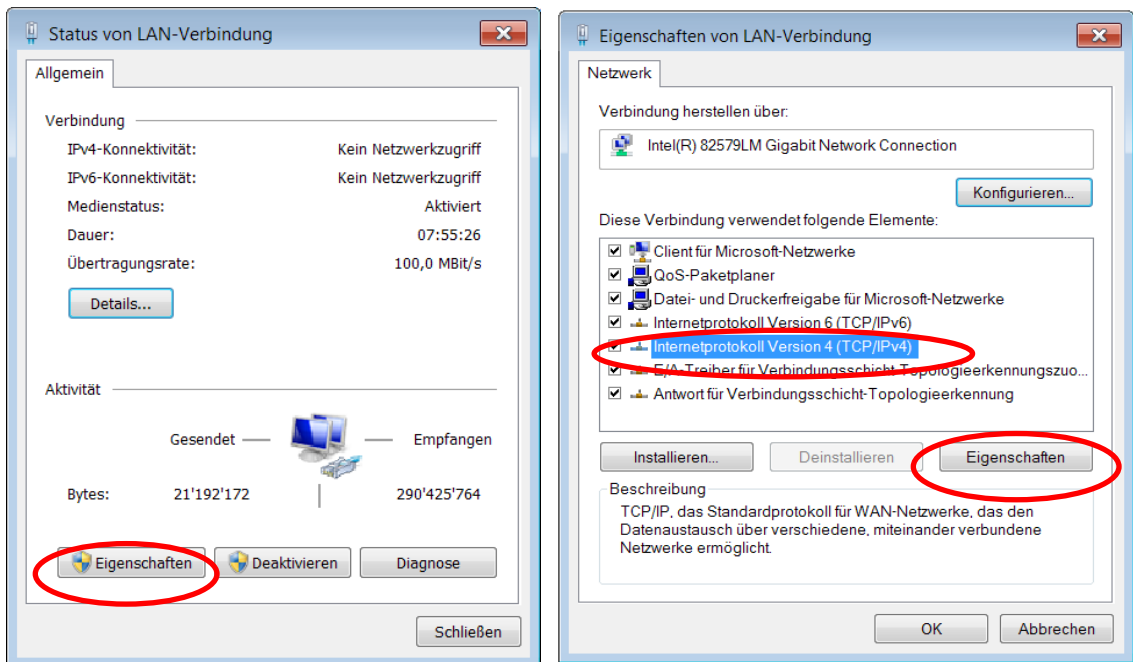

7. Click on Properties
8. On the next dialog box select the network adapter that is used for the connection. In our case "Internet protocol version 4 (TCP/IP)"
9. Click on Properties. The following dialog box "Internet protocol Version 4 (TCP/IPv4) Properties" will appear.

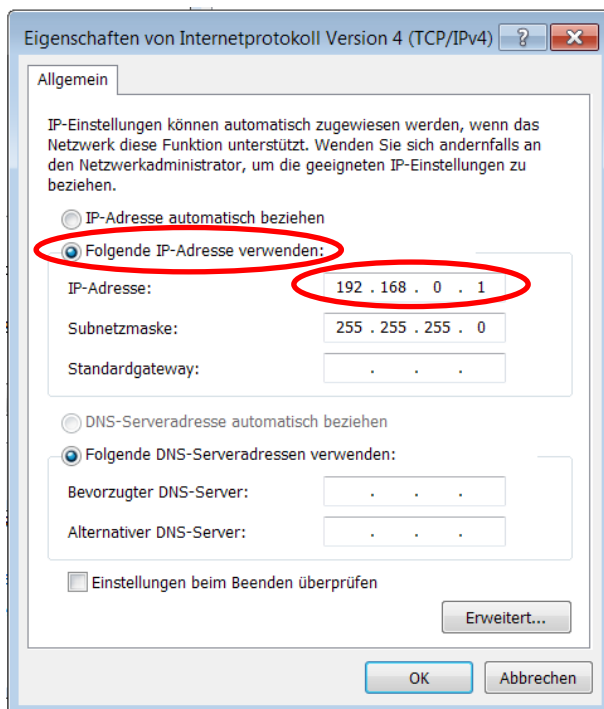

10. Select the radio button "Use the following IP address:"
11. Enter the IP address for the computer that could be **192.168.0.1**
12. In the Subnet mask, enter **255 255 255 000**, as shown above.
13. Click the "OK" button.
14. Close all windows

The computer is now ready to communicate with the web guide controller:

1. Open Microsoft Internet Explorer or Mizilla Firefox.
2. The default IP address for the CMGZ309 is **192.168.000.090** as long as it was not changed over the operating penal. Enter the IP address e.g. with <http://192.168.000.090> in the address bar and hit the Enter key.
3. If a different IP address and subnet mask is configured at the BKS309 make sure that the computer is setup appropriate.
4. The screen **Fig. 38** will open up. Continue then with the procedure described in **13.1** "Parametrization in a Network via a Web Browser"
5. Once you return to your office, don't forget to reconfigure your PC to "Automatic assignment of the IP-address" (see last dialog box).

16 Dimensions

The CMGZ309 series is available in four different housing options. The mechanical dimensions can be seen in the following pages.

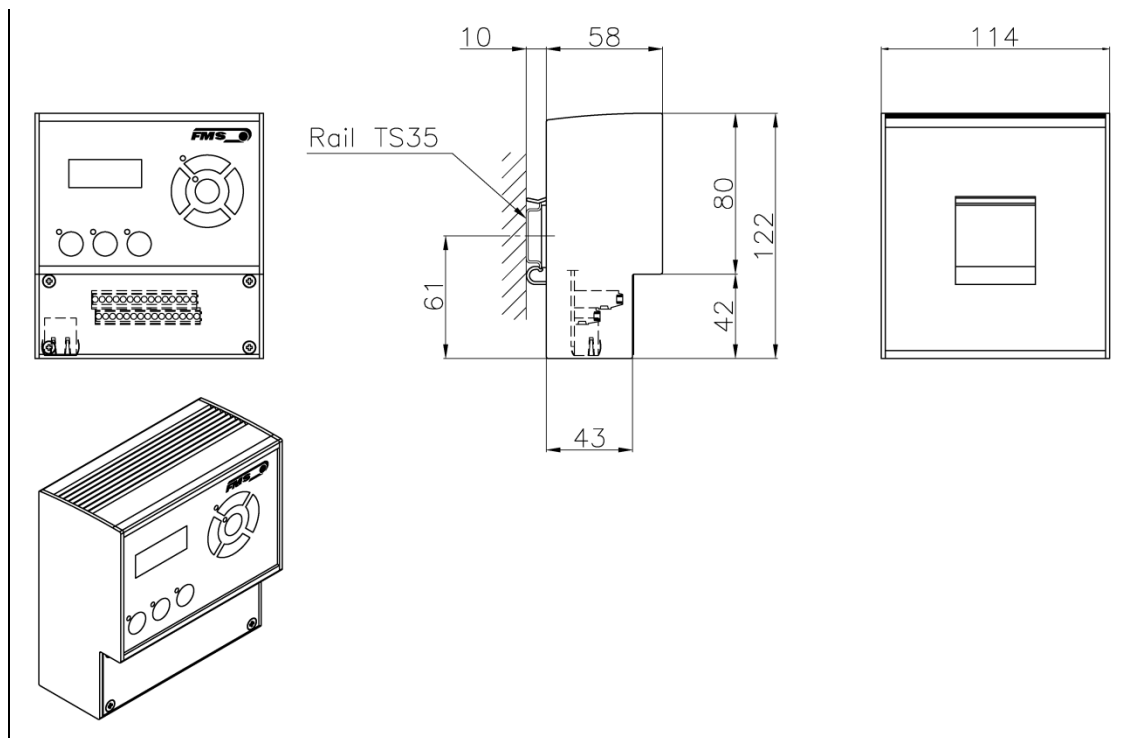

Fig. 47: Outline Drawing for CMGZ309.R rail mount housing
Ethernet connection: RJ-45 connector

C309001e

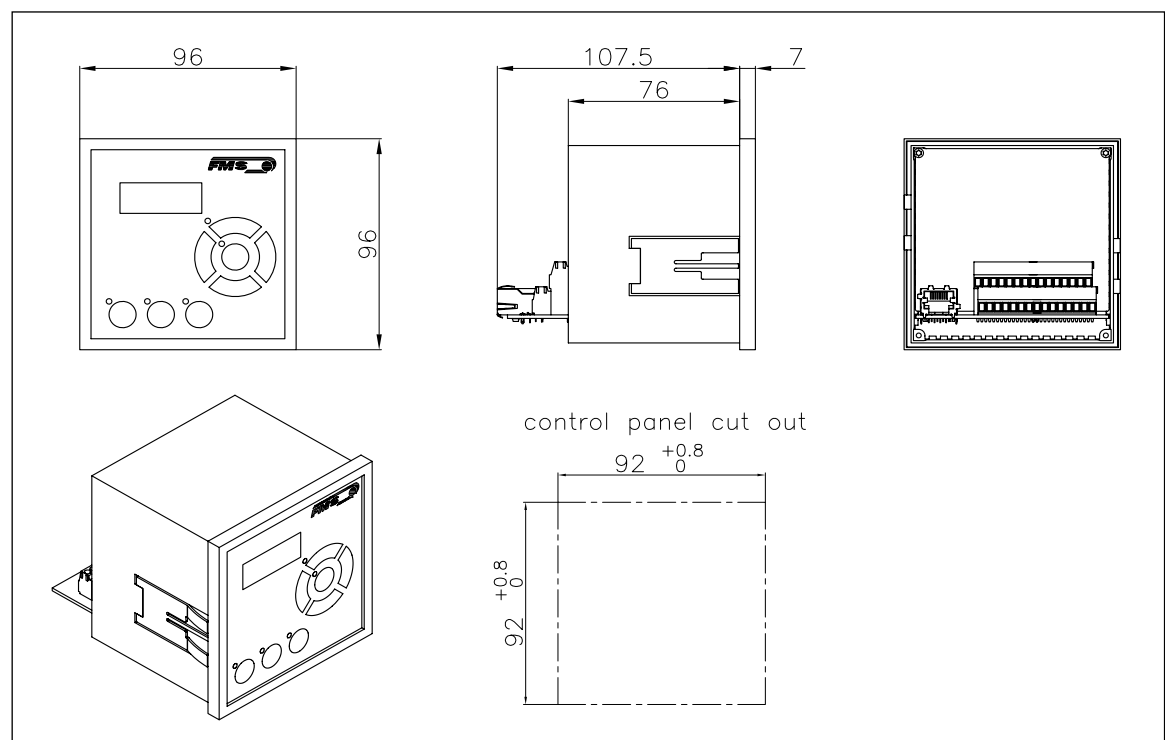

Fig. 48: Outline Drawing for CMGZ309.S panel mount housing (RJ-45)

C309002e

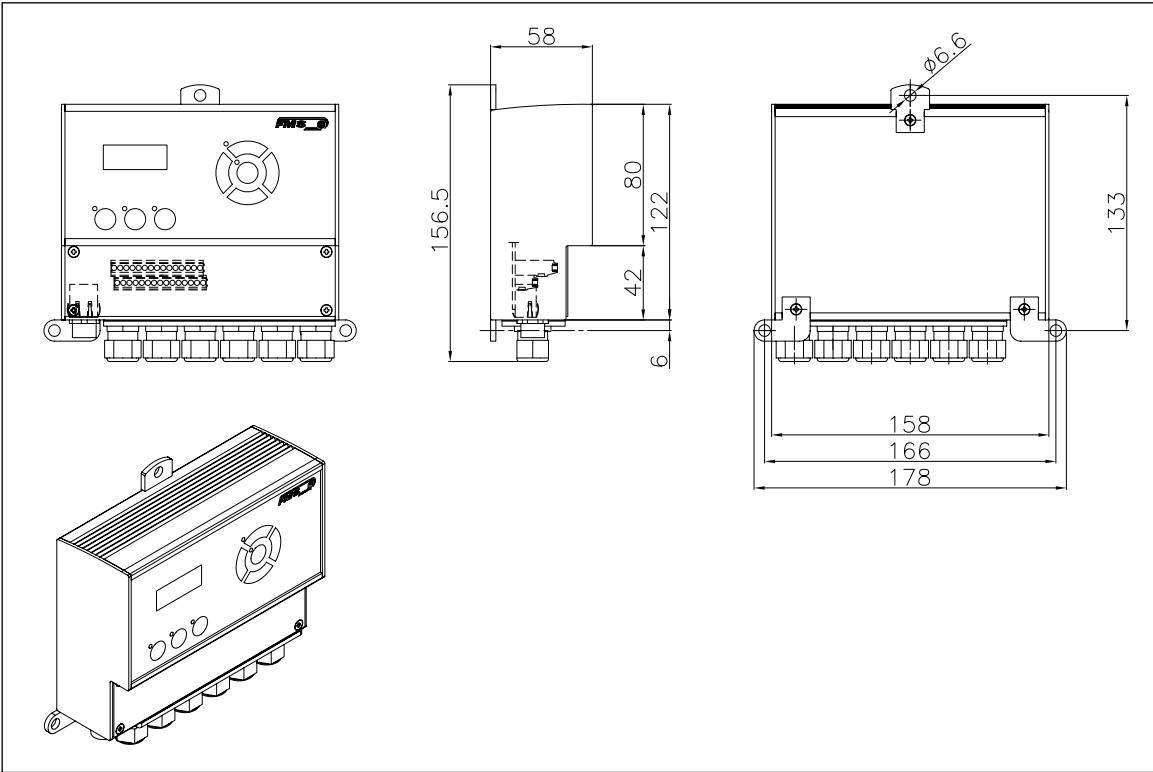

Fig. 49: Outline Drawing for CMGZ309.W wall mount housing
Ethernet connection: M12 4-pole D-coded

C309003

17 Trouble Shooting

17.1 General Trouble Shooting

Error	Cause	Corrective action
LCD Display black	Supply voltage in wrong range	Check supply voltage. It must be in the range 18-36VDC (Vnom= 24V)
In Parameter setting required parameters don't show up	Parameter <i>Control Mode</i> or special function does not correspond with actual application	Make sure parameters <i>PID conf</i> , <i>CtrlMode</i> and special functions match with your application.
Feedback value off	Offset badly adjusted	Proceed to <i>Adjustment Procedures</i> and do again <i>offset compensation</i>
Feedback is not 0 even though material is loose	Current output is set to 4...20mA	Set parameter <i>Out Mode</i> correctly to the wanted signal e.g. 0...20mA is
Feedback value off (not corresponding to actual tension)	Load cells badly calibrated	Proceed to <i>Adjustment Procedures</i> and do again <i>calibration</i>
	Feedback signal wrong scaled	Set parameter <i>Tens@10Vt</i> to an appropriate value (see 9.8).
	One load cell is not properly connected	Check wiring of load cells.
Jittery, unstable reading of feedback value	Cut off frequency of the filters set too high	Adjust cut off frequency of filters (ref. to 10.6 "Additional Settings")
	Earth ground or shield not connected	Check wiring, connect ground cables, ref. to chapters 4.4 to 4.6.
Limit switches do not work	Limit values wrongly parametrised	Set relay output parameters to appropriate values (ref. to 9.12 "I/O Parameter Group")
Relay outputs do not work	Wiring error	Check wiring of the relay outputs. Set parameters to appropriate values (ref. to 9.12 "I/O Parameter Group")

17.2 Unwind Brake Trouble Shooting

Error	Cause	Corrective action
Brake gives maximum torque (full braking)	Controller is enabled, but material is not tight	Tighten the material carefully to build-up a material tension
	Using pilot control, the diameter signal gives „0“; diameter sensor defect	Check diameter sensor and wiring. Replace it, if needed.
Brake doesn't work	Brake parameters wrongly set	Set parameter <i>Break</i> to the correct breaking current (see 9.12 "Input / Output parameter group")
	Wrong control mode	Check parameter <i>CtrMode</i> and set it to <i>UnwBreak</i> if necessary. Check the other break parameters.
Pilot control does not work as expected	Setup of pilot control failed	Repeat setup of pilot control, ref. to 11.7 "Setup of Pilot Control"

17.3 Unwind and Rewind Drive Trouble Shooting

Error	Cause	Corrective action
Roller stays or winds too slow when enabling the controller	Start speed set too low	Increase parameter <i>v Start</i> (see chapter 9.6 "Configuration Parameter Group").
	Start Limit set too high	Decrease parameter <i>StartLim</i> (see chapter 9.6)
Roller winds fast when enabling the controller. pos. material cracks	Start Limit set too low	Increase parameter <i>StartLim</i> (see chapter 9.6)
	Start Speed set too high	Decrease parameter <i>v Start</i> .
Roller winds much too fast when enabling the controller	Using pilot control: The diameter signal gives „0“. Diameter sensor defect	Check diameter sensor and wiring. Replace if needed
Pilot control does not work as expected	Setup of pilot control failed	Repeat setup of pilot control, ref. to 11.7 "Setup of pilot control"

17.4 Line Drive Trouble Shooting

Error	Cause	Corrective action
Roller stays when enabling controller; pos. material cracks	Using line speed overlay: The line speed signal is „0“. Tachometer generator defective	Check tachometer generator and wiring; replace if needed
Roller turns backwards when enabling controller; pos. material cracks	Line drive application wrongly parametrised (position of tachometer)	Check parameter <i>PosLnDrv</i> and correct if necessary position of tachometer (see chapter 9.4)
Line speed overlay does not work as expected	Setup of Line speed overlay failed	Repeat setup of Line speed overlay, ref. to 14.2 “Setup of Line Speed overlay“

18 Technical Specification

18.1 Technical Data

Number of Channel	1 Channel for 1 or 2 sensors
Sensor Supply	5 VDC, max. 60mA, high stability
Input signal range	0...9mV (max. 12.5mV)
Resolution A/D converter	±8192 Digit (14 Bit)
Measuring error	<0.05% FS
Processor cycle time	1ms
Operation	3 buttons, 5 buttons wind rose, LCD-display 2x8 characters (size 8mm)
Interfaces	Ethernet via web browser (Ethernet explorer 7 or higher)
Power supply	24VDC (18...36VDC) / 10W (max. 0.5A)
Temperature range	-10...60 °C (14...140 °F)
Protection class	CMGZ309.R and S: IP50 CMGZ309.W: IP65
Weight	CMGZ309.R: 0.57kg [1.26 lbs]; CMGZ309.S: 0.40kg [0.88 lbs]; CMGZ309.W: 0.72kg [1.56 lbs]

18.2 Input / Output Configuration

CMGZ309 Series Input / Output Configuration	
Analogue input 1	1 or 2 sensors with strain gauges @ 350 Ω (0...9 mV, max. 12.5 mV)
Analogue input 2	Reference potentiometer (0...10 VDC)
Analogue input 3	Diameter or line speed overlay (0...10 VDC)
Analogue output 1	Controller output signal (±10VDC, 0...10 VDC, 0/4...20mA)
Analogue output 2	Feedback value output (0...10VDC)
Digital Inputs	2 inputs @ 24 VDC galvanically isolated
Relay outputs	2 outputs (DC: 220V/2A/60W; AC:250V/2A/62.5VA)

FMS Force Measuring Systems AG
Aspstrasse 6
8154 Oberglatt (Switzerland)
Tel. 0041 1 852 80 80
Fax 0041 1 850 60 06
info@fms-technology.com
www.fms-technology.com

FMS USA, Inc.
2155 Stonington Avenue Suite 119
Hoffman Estates., IL 60169 (USA)
Tel. +1 847 519 4400
Fax +1 847 519 4401
fmsusa@fms-technology.com

FMS (UK)
Aspstrasse 6
8154 Oberglatt (Switzerland)
Tel. +44 (0)1767 221 303
fmsuk@fms-technology.com

FMS (Italy)
Aspstrasse 6
8154 Oberglatt (Switzerland)
Tel. +39 02 39487035
fmsit@fms-technology.com

