

Low Pressure Filter/Suction Filter Pi 220

Nominal pressure 10 bar (140 psi), up to nominal size 160

1. Features

High performance filters for modern hydraulic systems

- Provided for pipe installation
- Modular system
- Compact design
- Minimal pressure drop through optimal flow design
- Visual/electronic/electrical maintenance indicator
- Threaded connections
- Quality filters, easy to service
- Equipped with highly efficient Mic or Sm-x filter elements
- Beta rated elements according to ISO 16889
- Elements with high differential pressure stability and dirt holding capacity
- Worldwide distribution



2. Flow rate/pressure drop curve complete filter

■ 190 mm²/s
■ 33 mm²/s

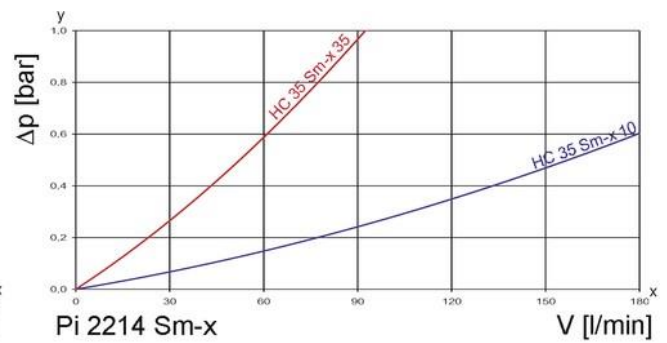
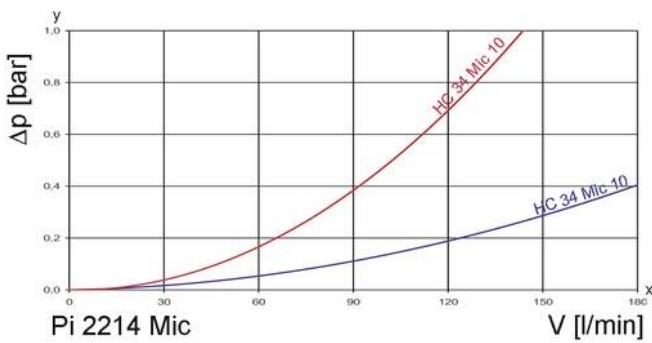
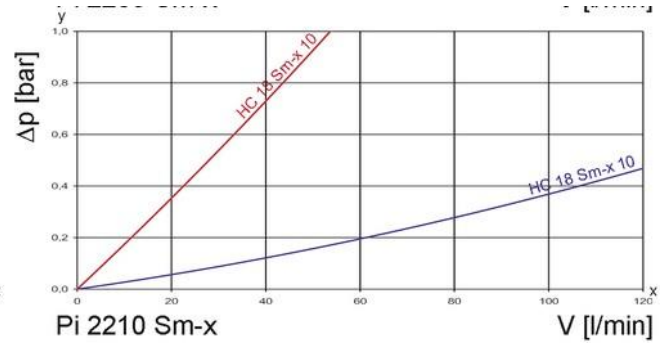
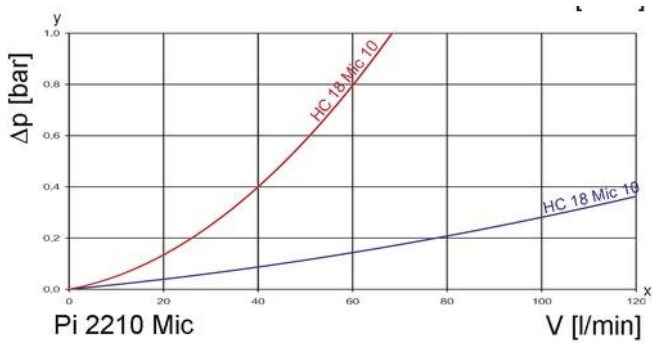
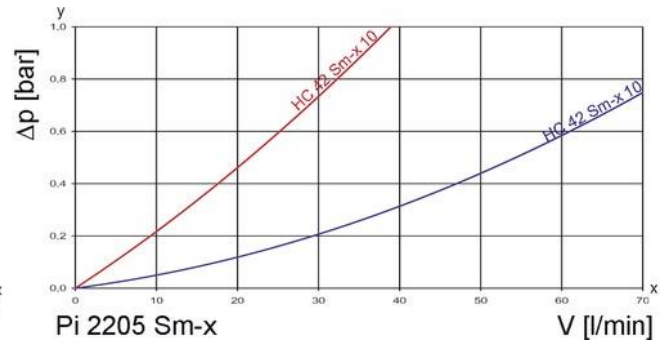
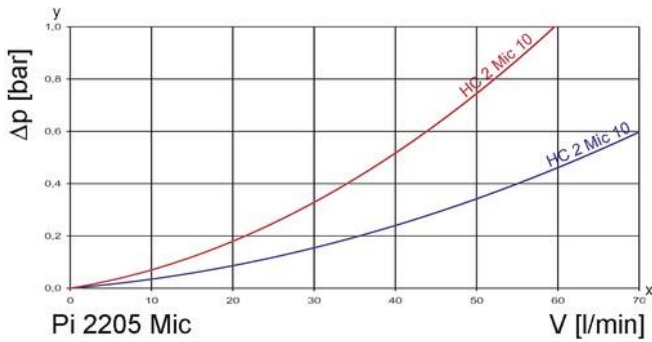
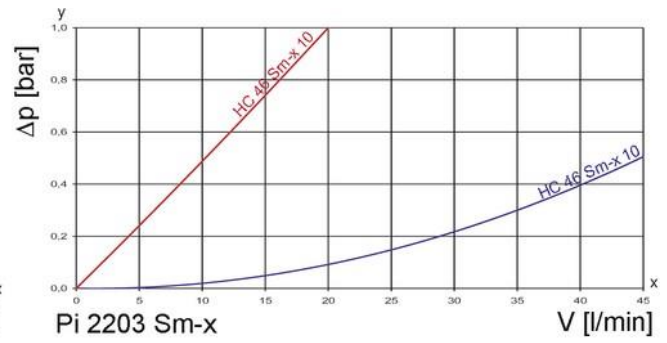
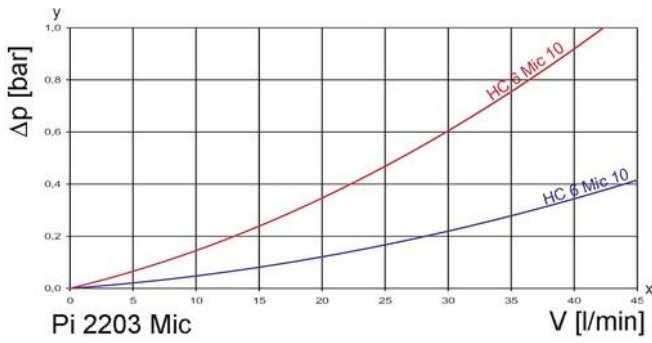
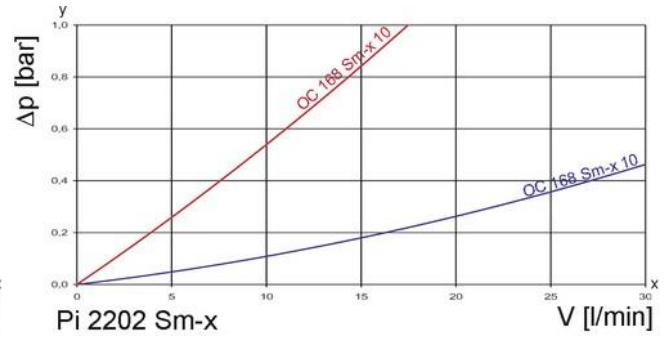
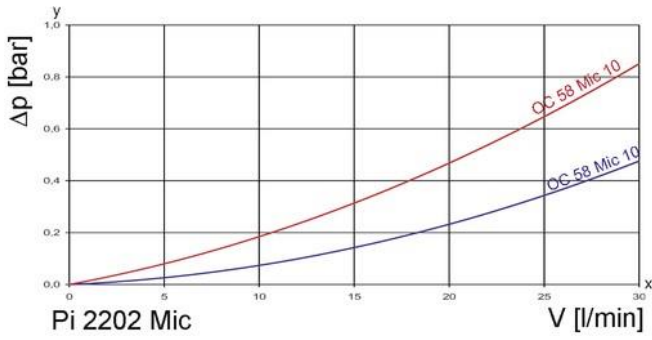

y = differential pressure Δp [bar]
 x = flow rate V [l/min]

3. Separation grade characteristics

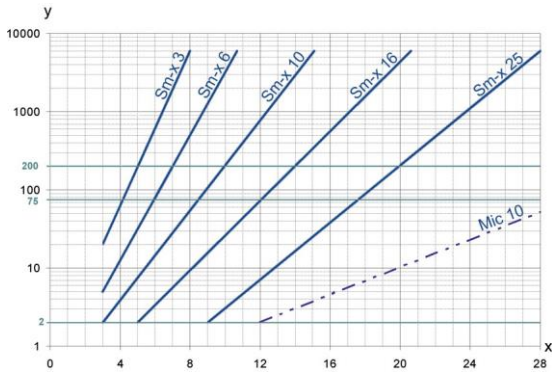

y = beta-value
x = particle size [μm]

determined by multipass tests (ISO 16889)
calibration according to ISO 11171 (NIST)

5. Quality assurance

Filtration Group filters and filter elements are produced according to the following international standards:

Norm	Designation
DIN ISO 2941	Hydraulic fluid power filter elements; verification of collapse/burst resistance
DIN ISO 2942	Hydraulic fluid power filter elements; verification of fabrication integrity
DIN ISO 2943	Hydraulic fluid power filter elements; verification of material compatibility
DIN ISO 3723	Hydraulic fluid power filter elements; method for end load test
DIN ISO 3724	Hydraulic fluid power filter elements; verification of flow fatigue characteristics
ISO 3968	Hydraulic fluid power-filters-evaluation of pressure drop versus flow characteristics
ISO 10771.1	Fatigue pressure testing of metal containing envelopes in hydraulic fluid applications
ISO 16889	Hydraulic fluid power filters-multipass method for evaluation filtration performance of a filter element

6. Symbols

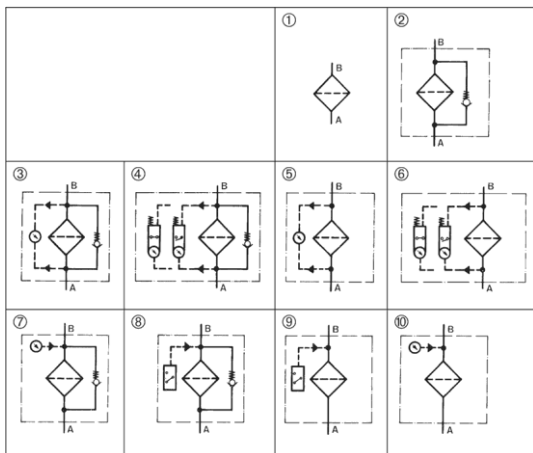

4. Filter performance data

tested according to ISO 16889 (multipass test)

Sm-x-elements with
max. Δp 5 bar

Sm-x 10 $\beta_{10(C)} \geq 200$

values guaranteed up to
5 bar differential pressure

7. Order numbers

Example for ordering filters:

1. Housing design	2. Spin-on cartridge
V = 25 l/min, bypass, electrical maintenance indicator Type: Pi 2202-058 Order number: 77665649	Mic 10 Type: OC 58 Order number: 77785983

7.1 Housing design/order number for pressure-side installation								
Nominal size NG [l/min]	Order number	Type	① no options	② with by- pass valve	③ with bypass valve and visual indicator	④ with bypass valve and electrical indicator	⑤ with visual indicator	⑥ with electrical indicator
25	77665656	Pi 2202-060						
	77665623	Pi 2202-056						
	77665631	Pi 2202-057						
	77665649	Pi 2202-058						
	77665664	Pi 2202-068						
	77665672	Pi 2202-069						
40	77665714	Pi 2203-060						
	77665680	Pi 2203-056						
	77665698	Pi 2203-057						
	77665706	Pi 2203-058						
	77665748	Pi 2203-068						
	77665755	Pi 2203-069						
63	77665813	Pi 2205-060						
	77665789	Pi 2205-056						
	77665797	Pi 2205-057						
	77665805	Pi 2205-058						
	77665847	Pi 2205-068						
	77665854	Pi 2205-069						
100	77666001	Pi 2210-060						
	77665979	Pi 2210-056						
	77665987	Pi 2210-057						
	77665995	Pi 2210-058						
	77666050	Pi 2210-068						
	77666068	Pi 2210-069						
160	77666126	Pi 2214-060						
	77666092	Pi 2214-056						
	77666100	Pi 2214-057						
	77666118	Pi 2214-058						
	77666183	Pi 2214-068						
	77666191	Pi 2214-069						

When filter with non bypass configuration is selected, the collapse pressure of the spin-on cartridge must not be exceeded.

7.2 Spin-on cartridges

Nominal size NG [l/min] Press./Suct. side	Order number	Type	Filter material	max. Δp [bar]	Filter surface [cm ²]
25/10	77785983	OC 58	Mic 10	5	1775
	77500184	OC 168	Sm-x 10		1309
40/16	77501273	HC 6	Mic 10	5	3000
	77501232	HC 46	Sm-x 10		2075
63/25	72013241	HC 2	Mic 10	5	5440
	77501372	HC 42	Sm-x 10		3360
100/40	77643331	HC 18	Mic 10	5	7000
	77643398	HC 28	Sm-x 10		3400
160/63	77504194	HC 34	Mic 10	5	14025
	77643844	HC 35	Sm-x 10		7638

7.3 Housing design/order numbers for suction-side installation

Nominal size NG [l/min]	Order number	Type	① no options	② with bypass 0.25 bar	⑦ with bypass 0.25 bar and vacuum gauge	⑧ with bypass 0.25 bar and vacuum switch	⑨ with vacuum switch	⑩ with vacuum gauge
10	77665656	Pi 2202-060						
	77736614	Pi 2202-067						
	77736622	Pi 2202-062						
	77736630	Pi 2202-061						
	77736606	Pi 2202-065						
	77736598	Pi 2202-066						
16	77665714	Pi 2203-060						
	77665730	Pi 2203-067						
	77736689	Pi 2203-062						
	77736697	Pi 2203-061						
	77736671	Pi 2203-065						
	77665722	Pi 2203-066						
25	77665813	Pi 2205-060						
	77736747	Pi 2205-067						
	77665821	Pi 2205-062						
	77736754	Pi 2205-061						
	77665839	Pi 2205-065						
	77736739	Pi 2205-066						
40	77666001	Pi 2210-060						
	77735947	Pi 2210-067						
	77666027	Pi 2210-062						
	77666019	Pi 2210-061						
	77666035	Pi 2210-065						
	77666043	Pi 2210-066						
63	77666126	Pi 2214-060						
	77666175	Pi 2214-067						
	77666142	Pi 2214-062						
	77666134	Pi 2214-061						
	77666159	Pi 2214-065						
	77666167	Pi 2214-066						

When filter with non bypass configuration is selected, the collapse pressure of the spin-on cartridge must not be exceeded.

8. Technical specifications

Design: line mounting filter
 Nominal pressure: 10 bar (140 psi)*
 Test pressure: 13 bar (180 psi)
 Temperature range: -10 °C to +120 °C
 (other temperature ranges on request)

Bypass setting:
 Pressure side: Δp 3.5 bar \pm 10%
 Suction side: Δp 0.25 bar \pm 10%
 Filter head material: GDAL
 Filter housing material: St
 Sealing material: NBR/AL
 Maintenance indicator setting: Δp 2.2 bar \pm 0.3 bar
 Indicating range vacuum meter: -1 bar to +1.5 bar
 Pressure setting vacuum switch: 200 mbar
 Type of protection (suction side): IP 54
 Electrical data of maintenance indicator:
 Max. voltage: 250 V AC/200 V DC
 Max. current: 1 A
 Contact load: 70 W
 Type of protection: IP 65 in inserted and secured status

Contact: normally open/closed
 Cable sleeve: M20x1.5

The switching function can be changed by turning the electric upper part by 180° (normally closed contact or normally open contact). The state on delivery is a normally closed contact. By inductivity in the direct current circuit the use of suitable protection circuit should be considered. Further maintenance indicator details and designs are available in the maintenance indicator data sheet.

We draw attention to the fact that all values indicated are average values which do not always occur in specific cases of application. Our products are continually being further developed. Values, dimensions and weights can change as a result of this. Our specialized department will be pleased to offer you advice.

We recommend you to contact us concerning applications of our filters in areas governed by the EU Directive 94/9 EC (ATEX 95). The standard version can be used for liquids based on mineral oil (corresponding to the fluids in Group 2 of Directive 97/23 EC Article 9). If you consider to use other fluids please contact us for additional support.

* For the contamination of the housing designs as per 7.1 with medium-pressure spin-on cartridges refer to leaflet "spin-on cartridges" for dimensions and specifications. Operating pressure on request.

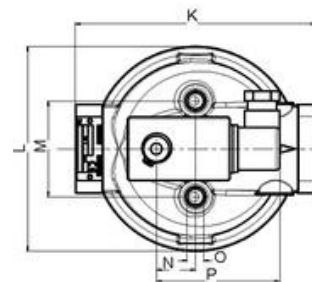
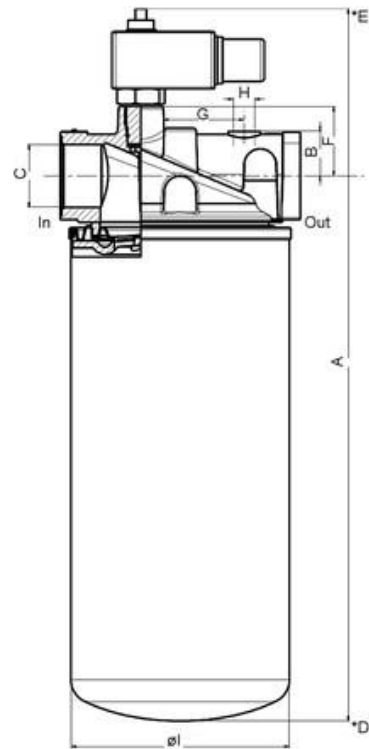

Pi 2210 - Pi 2214

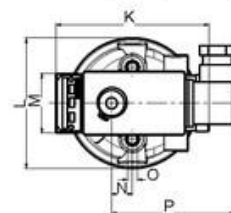

Pi 2202 - Pi 2205

In = Inlet

Out = Outlet

*D = Height required for spin-on cartridge removal

*E = Height required for maintenance indicator removal

Subject to technical alteration without prior notice.

9. Dimensions

All dimensions except "C" and "H" in mm.

Type	A	B	C	D	E	F	G*	H*	I	K	L	M	N	O	P	Weight [kg]
Pi 2202	241	19	G½	30	45	37.5	23.5	G1/8	76	95	80	45	13.0	M8x10	78	0.90
Pi 2203	261	19	G½	30	45	37.5	23.5	G1/8	93	95	80	45	13.0	M8x10	78	1.00
Pi 2205	328	19	G¾	30	45	37.5	23.5	G1/8	93	95	80	45	13.0	M8x10	78	1.25
Pi 2210	302	30	G1¼	40	45	43.5	40.0	G1/8	136	150	128	60	24.5	M12x15	78	2.30
Pi 2214	442	30	G1¼	40	45	43.5	40.0	G1/8	136	150	128	60	24.5	M12x15	78	2.70

*with suction-side installation only.

10. Installation, operating and maintenance instructions

10.1 Filter installation

When installing the filter make sure that sufficient space is available to remove spin-on cartridge. Filter should be installed with the spin-on cartridge pointing downwards.

The maintenance indicator must be visible.

10.2 Connecting the electrical maintenance indicator

The electrical indicator is connected via a 2-pole appliance plug according to DIN EN 175301-803 with poles marked 1 and 2.

The electrical section can be inverted to change from normally open position to normally closed position or vice versa.

10.3 When should the filter element be replaced?

- Filters equipped with visual and electrical maintenance indicator:

During cold starts, the indicator may give a warning signal. Press the red button of the visual indicator once again only after operating temperature has been reached. If the red button immediately pops up again and/or the electrical signal has not switched off after reaching operating temperature, the filter element must be replaced after the end of the shift.
- Filters without maintenance indicator:

The filter element should be replaced after the trial run or flushing of the system. Afterwards follow instructions of the manufacturer.
- Please always ensure that you have original Filtration Group spare elements in stock: disposable elements (Sm-x) cannot be cleaned.

10.4 Spin-on cartridge exchange

- Stop system and relieve filter from pressure.
- Unscrew the spin-on cartridge with the aid of a belt spanner by turning same to the left
- Make sure that the order number on the spin-on cartridge corresponds to the order number of the plate.
- The seal of the screw-on cartridge should be lightly oiled.
- Screw cartridge on in accordance with the printed-on instructions.

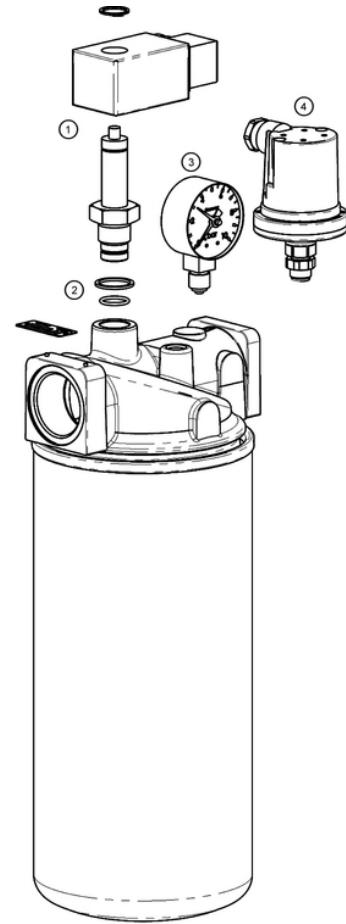

11. Spare parts list

Order numbers for spare parts		
Position	Type	Order number
①	Maintenance indicator	
	Visual PiS 3098	77669971
	Electrical PiS 3097	77669948
	Electrical upper part only	77536550
②	Seal kit for maintenance indicator	
	NBR	77760309
③	Vacuum gauge	76345763
④	Vacuum switch PiS 3070	77669724

Filtration Group GmbH
Schleifbachweg 45
D-74613 Öhringen
Phone +49 7941 6466-0
Fax +49 7941 6466-429
fm.de.sales@filtrationgroup.com
www.fluid.filtrationgroup.com
78356610.06/2019
[Low Pressure Filter/Suction Filter Pi 220 up to NG 160](#)