

UPT-6011

Operating instructions



The CIRUS[®] temperature controller UPT-6011 is a key component in an ULTRA-PULSE system, because it is responsible for all heat management functions, i.e. controlling the temperature of the heating element.

Important features

- Complete control via EtherNet/IP[™] interface (2 x RJ-45)
- Automatic zeroing (AUTOCAL)
- Automatic configuration of the secondary voltage and current range (AUTORANGE)
- Automatic frequency adaptation
- Booster output standard
- Analogue output 0...10 VDC for ACTUAL temperature
- Alarm function with error diagnosis
- Heating element alloy and temperature range can be selected
- Cooling system monitored
- Wide voltage range for the use of 110...415 V
- Eight channels for administration of various calibration values
- Micro-USB interface for ROPEXvisual[®]
- cULus approval

Contents

1	Revision list	3	8	Device functions	20
2	General information	3	8.1	LEDs and controls	20
2.1	Copyright	3	8.2	EtherNet/IP™ communication	21
2.2	Intended use	3	8.3	Device description file (EDS)	22
2.3	Heating element	4	8.4	Communication protocol	22
2.4	Impulse transformer	4	8.5	Input data	23
2.5	Current transformer PEX-W4/-W5	4	8.6	Output data	25
2.6	Line filter	4	8.7	Parameter object (class: 0x0F)	28
2.7	Standards / CE marking	4	8.8	Integrated web server	52
2.8	Maintenance	5	8.9	Undervoltage detection	56
2.9	Transportation	5	8.10	Temperature meter (actual value output)	57
2.10	Disposal	5	8.11	Booster connection	58
3	Application	6	8.12	USB interface for visualization software ROPEXvisual®	58
4	System description	7	8.13	AUX interface	59
4.1	Functional principle	7	8.14	Total cycle counter	59
5	Device features	8	8.15	Operating hours counter	59
6	Mounting and installation	9	8.16	Data memory for error messages and AUTOCAL	59
6.1	Installation notes	9	8.17	Built-in clock (date and time)	59
6.2	Installation procedure	9	8.18	System monitoring / alarm output	60
6.3	Power supply	11	8.19	Error messages	61
6.4	Line filter	12	8.20	Fault areas and causes	65
6.5	Current transformer PEX-W4/-W5	12	9	Factory settings	66
6.6	Wiring diagram (standard)	14	10	Technical data	67
6.7	Wiring diagram with booster connection	15	11	Dimensions	69
7	Startup and operation	16	12	Modifications (MODs)	69
7.1	View of the device	16	13	How to order	70
7.2	Device configuration	16	14	Index	72
7.3	Heating element	18			
7.4	Commissioning rules	19			

1 Revision list

Version	Change
1	<ul style="list-style-type: none"> • Creation of documentation
2	<ul style="list-style-type: none"> • Change to one column layout • ROPEX logo changed • Covering page with important features • Additions in general information <ul style="list-style-type: none"> ↳ section 2 "General information" on page 3 • Addition in Communication protocol: Status bit measurement interruption <ul style="list-style-type: none"> ↳ section 8.6.10 "Measurement interruption (MU)" on page 27 • Extension of parameter object with instances 62 to 78: absolute calibration resistances <ul style="list-style-type: none"> ↳ page 41 • Extension integrated webserver: presentation of calibration values <ul style="list-style-type: none"> ↳ section 8.8.6 "Calibration page" on page 55 • Updating of how to order <ul style="list-style-type: none"> ↳ section 13 "How to order" on page 70

2 General information

This CIRUS[®] temperature controller is manufactured according to DIN EN 61010-1. In the course of its manufacture it passed through quality assurance, whereby it was subjected to extensive inspections and tests. As a result of this, the product left our factory in perfect condition.

Please carefully read through the operating manual before using the CIRUS[®] temperature controller. Keep the operating manual for later reference and make sure that information and functions important for the user are available.

The recommendations and warning notes contained in these operating instructions must be complied with, in order to guarantee safe operation.

The device can be operated within the limits indicated in the "Technical Data" without impairing its operational safety. Installation and maintenance may only be performed by technically trained, skilled persons who are familiar with the associated risks and warranty provisions.

2.1 Copyright

All contents, in particular texts, photographs and graphics, are protected by copyright. All rights, including to replication, publication, editing and translation, are reserved.

2.2 Intended use

CIRUS[®] temperature controllers may only be used for heating and temperature control of heatsealing elements which are expressly approved for them, and providing the regulations, notes and warnings contained in these instructions are observed.

In case of non-observance or use contrary to the intended purpose, there is a risk that safety will be impaired or that the heatsealing element, electrical wiring, transformer etc. will overheat. This is the personal responsibility of the user.

2.3 Heating element

The temperature coefficient of a CIRUS[®] temperature controller is specially adapted to CIRUS heating elements.



The CIRUS[®] temperature controller is not allowed to be operated with any other heatsealing elements because they could be overheated and damaged beyond repair.

2.4 Impulse transformer

A suitable impulse transformer is necessary in order to guarantee trouble-free operation of the control loop. This transformer must be designed according to EN 61558 (isolating transformer with reinforced insulation) and have a one section bobbin. When the impulse transformer is installed, suitable touch protection must be provided in accordance with the national installation regulations for electrical equipment. In addition to this, water, cleaning solutions and conductive fluids must be prevented from seeping into the transformer.

Incorrect installation of the impulse transformer impairs electrical safety.

2.5 Current transformer PEX-W4/-W5

The current transformer supplied with the CIRUS[®] temperature controller is an integral part of the control system. Only the original ROPEX PEX-W4 or PEX-W5 current transformer may be used. Other transformers may cause the equipment to malfunction.

The current transformer may only be operated if it is correctly connected to the CIRUS[®] temperature controller (see section "Startup and operation"). The relevant safety instructions contained in section "Power supply", must be observed. External monitoring modules can be used in order to additionally increase operating safety. They are not included in the scope of supply of the standard control system and are described in a separate document.

2.6 Line filter

ROPEX provides line filters in different power classes. The ROPEX application report lists the suitable line filter which can be ordered accordingly.

The use of an original ROPEX line filter is mandatory in order to comply with the standards and provisions mentioned in section 2.7 "Standards / CE marking" on page 4. This device must be installed and connected according to the instructions contained in section "Power supply" as well as the separate documentation enclosed with the line filter.

2.7 Standards / CE marking

The controller described here complies with the following standards, provisions and directives:

DIN EN 61010-1:2001 (2014/35/EU)	Safety requirements for electrical equipment for measurement, control and laboratory use (low-voltage directive): pollution degree 2, protection class I, measurement category I (for U _R and I _R terminals)
DIN EN 60204-1 (2006/42/EG)	Electrical equipment of machines (machinery directive)

EN 55011:2009+A1:2010 EN 61000-3-2:2006-04+A1:2009+A2:2009 EN 61000-3-3:2008 EN 61000-6-4:2007+A1:2011 (2014/30/EU)	EMC generic emissions: Group 1, Class A
EN 61000-6-2:2005 (2014/30/EU)	EMC generic immunity: Class A (ESD, RFI, burst, surge) <u>Exception:</u> Line voltage interruption acc. to EN 61000-4-11 is not fulfilled (this leads to a designated error message of the controller)
2011/65/EU	Directive on the restriction of the use of certain hazardous substances in electrical and electronic equipment.

Compliance with these standards and provisions is only guaranteed if original accessories and / or peripheral components approved by ROPEX are used. If not, then the equipment is operated on the user's own responsibility. The CE marking on the controller confirms that the device itself complies with the above-mentioned standards. It does not imply, however, that the overall system also fulfills these standards.

It is the responsibility of the machine manufacturer and of the user to verify the completely installed, wired and operationally ready system in the machine with regard to its conformity with the safety provisions and the EMC directive (see also section "Power supply"). If peripheral components (e.g. the transformer or the line filter) from other manufacturers are used, no functional guarantee can be provided by ROPEX.

2.8 Maintenance

The controller requires no special maintenance. Regular inspection and / or tightening of the terminals – including the terminals for the winding connections on the impulse transformer – is recommended. Dust deposits on the controller can be removed with dry compressed air.



Dust deposits and dirt from liquids result in a loss of function. Accordingly, installation in a switch cabinet or terminal cabinet with IP54 is recommended.

2.9 Transportation

Store and transport the device in its original carton.
After transport, perform a visual inspection for possible damage.

2.10 Disposal



This device is subject to Directive 2012/19/EU concerning the reduction of the increasing amount of waste electrical and electronic equipment and the disposal of such waste in an environmentally sound way.

To guarantee proper disposal and / or the recover of reusable material, please take the device to a designated municipal collection point and observe local regulations.

Careless, uncontrolled disposal can cause damage to the environment and human health. By ensuring that your product is disposed of or recycled in a responsible way, you can help protect the environment and human health.



This device must not be disposed of as residual waste!

3 Application

This CIRUS[®] temperature controller is an integral part of the "series 6000". Its sole purpose is to control the temperature of CIRUS/UPT heating elements. The main application area is sealing or cutting of thermoplastics using the thermal impulse process.

The most common application areas are:

- vertical and horizontal form-fill-seal machines (VFFS and HFFS)
- bagging, filling and sealing machines
- bag-production machines
- foil welding devices
- foil splicer
- etc.

4 System description

Sample depiction

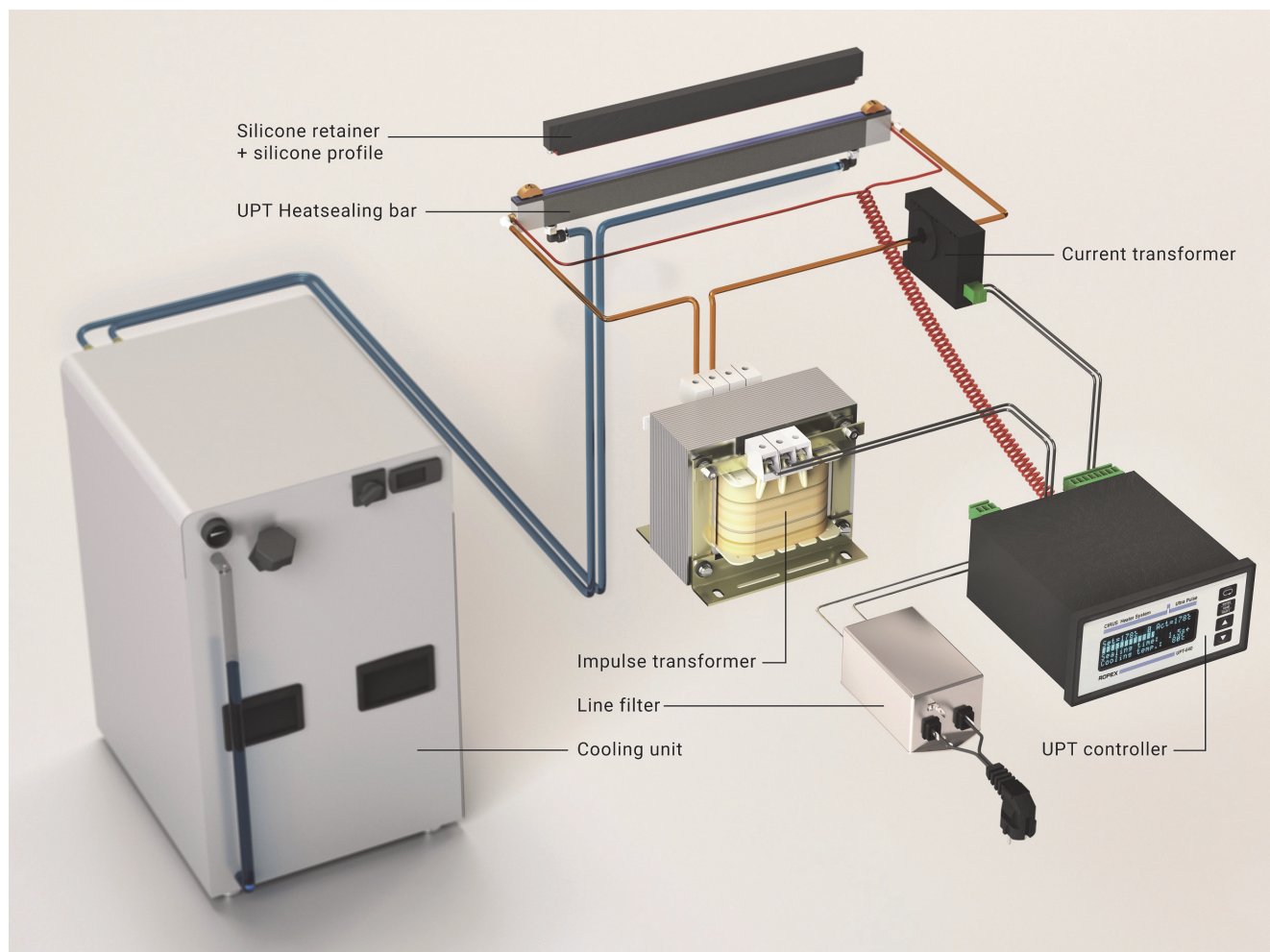

The basic design of the overall system is shown in the diagram above.

CIRUS heating elements, and in particular UPT heating elements, are high-performance systems which operate efficiently and reliably providing all the components in the control loop are optimally tuned to one another – and to the task at hand. Exact compliance with the installation and wiring instructions is essential. The system has been evolved and optimized by ROPEX GmbH in an intensive development process. Users who follow our technical recommendations will profit from the unique functionality of this technology, which reduces the customer's effort for installation, commissioning and maintenance to a minimum.

4.1 Functional principle

The controller determines the resistance of the heating element by measuring the current and voltage at a high sampling rate (corresponds to the line frequency), compares it with the set point and – if the difference is not 0 – adjusts the heating current with the help of a phase controlled transformer so that set = actual.

A highly dynamic thermoelectric control loop is established in this way because purely electrical variables are measured in rapid succession and the heating layer of the UPT heating element has a small mass.

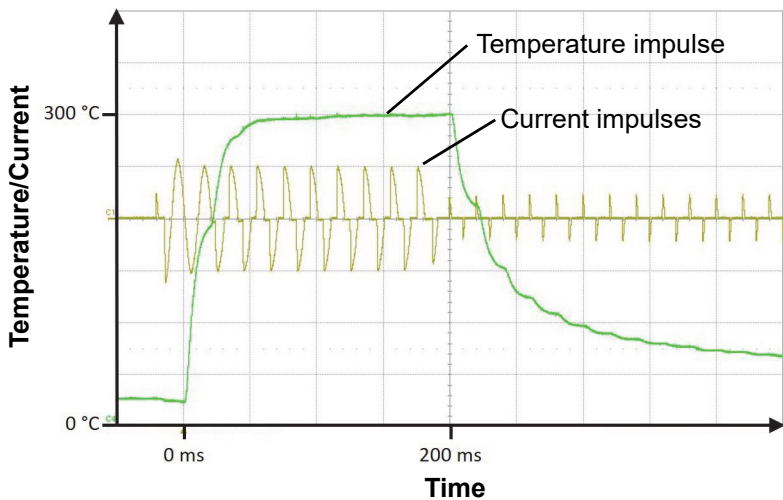

Thanks to the microprocessor based technology, the controller has an optimized control algorithm as well as numerous functions tailored to specific tasks such as AUTOCAL, ALARM with error diagnosis etc. These are described in detail below.

5 Device features

The CIRUS[®] temperature controller UPT-6011 is equipped with a EtherNet/IP[™] interface. Through this interface, all functions and parameters can be parameterised by means of the higher level machine controller. In addition, important controller information is queried and can be processed accordingly.

The ACTUAL temperature of the heating element is output through the EtherNet/IP[™] interface and through an analogue output 0...10 VDC. The real heating element temperature can be visualised on an external display instrument (e.g. ATR-x) or via the operating unit of the machine controller.

The UPT-6011 has an integrated error diagnosis that checks both the external system (heating element, wiring, etc.) and the internal electronics. A differentiated error message is output through the EtherNet/IP[™] interface in case of malfunction.

To increase operational security and immunity to interference, all EtherNet/IP[™] signals from the controller and heating circuit are electrically isolated.

Adjustment for different heating element alloys and setting of the temperature range to be used (0...300 °C or 0...500 °C) can be made through coding switches on the temperature controller itself or through the EtherNet/IP[™] interface.

The compact design of the CIRUS[®] temperature controller UPT-6011 as well as the plug-in connecting terminals make mounting and installation easier.

An overview of the most important features and functions:

- Easy calibration of the heating element through AUTOCAL, the automatic zero-point setting.
- Eight channels permit switching of the calibration parameters during tool change.
- High flexibility: The AUTORANGE function covers a secondary voltage range of 0.4 V to 120 V and a current range of 30 A to 500 A.
- Automatic adjustment to the network frequency in the range of 47 Hz to 63 Hz.
- Wide voltage range for flexible use from 110 VAC to 415 VAC
- Easy and convenient system diagnosis and process visualisation through the free, downloadable software ROPEXvisual[®]

- Comprehensive error diagnosis over the EtherNet/IP™ interface
- Booster output available for connecting a switching amplifier
- High process security through comprehensive options for evaluating the parameter data (e.g. temperature diagnosis or heat-up time monitoring)

6 Mounting and installation

↳ See also section 2 "General information" on page 3.



Mounting, installation and startup may only be performed by authorized persons who have received suitable instruction and are familiar with the associated risks and warranty provisions.



The supply voltage to the machine side must lie within the permitted voltage and frequency range of the CIRUS® temperature controller. Otherwise, there is the danger of a defect.

6.1 Installation notes

1. Please refer to the safety and warning notes (↳ "General information" on page 3.).
2. The information provided in the customized ROPEX Application Report, which is specifically prepared by ROPEX for each application, must be observed.
3. All electrical components such as the controller, impulse transformer, and line filter, should be installed as close as possible to the UPT sealing bar(s) in order to avoid unnecessarily long cables.
4. Connect the voltage measurement cable UR directly to the UPT sealing bar and lay it twisted to the controller (for the UML-1 voltage measurement cable see ↳ "How to order" on page 70.).
5. Ensure an adequate cable cross-section for the primary and secondary circuits (Ä Application Report).
6. Use only ROPEX impulse transformers or transformers approved by ROPEX. Please note the power, duty cycle, and primary and secondary voltages (Ä Application Report).

6.2 Installation procedure

Proceed as follows to install the CIRUS® temperature controller UPT-6011:

1. Switch off the line voltage and the 24 VDC supply, and verify that the circuit is de-energized.
2. Mount the CIRUS® temperature controller on a standard top hat rail (TS35 rail according to DIN EN 50022) in the electrical cabinet. If several controllers are mounted on one rail, the minimum clearance specified in section 10 "Technical data" on page 67 must be allowed between them.
3. Wire the system in accordance with the instructions in section 6.1 "Installation notes" on page 9, section 6.6 "Wiring diagram (standard)" on page 14, and the ROPEX Application Report. The information provided in section 6.1 "Installation notes" on page 9 must also be observed.
Wires used for control or measuring connections must always be laid inside the building.
4. An overcurrent protective device with a maximum rating of 10 A must be fitted when the device is installed, e.g.:
 - Miniature circuit breaker to EN 60898 (B, C, D, K, or Z characteristic)
 - Miniature circuit breaker to UL 489 (*) (B, C, D, K, or Z characteristic)
 - Fuse gG to IEC 60269
 - Class CC or Class J fuse to UL 248 (*)

The overcurrent protective devices marked (*) should be used in installations conforming to UL standards.

If one such device is not adequate for the heatsealing application, two separate overcurrent protective devices should be provided – one for the controller and one for the application (↪ ROPEX Application Report).

The overcurrent protective device must be located directly adjacent to the controller.

The minimum possible specification for this device is indicated in the ROPEX Application Report based on the calculated currents. If a larger overcurrent protective device is fitted, you must match the current carrying capacity of the other components accordingly (e.g. cables, impulse transformer etc.).

5. A disconnecting device must be provided when the system is installed; it must be marked as belonging to the system and fitted in a readily accessible position.
If a miniature circuit breaker is used, it can also perform the function of this device.
6. Connect the CIRUS temperature controller to the EtherNet/IP™ scanner using a suitable (standard compliant) cable.



Check that all system connections – including the terminals for the impulse transformer windings – are securely attached.

7. Make sure the wiring conforms to all relevant national and international installation regulations.

6.3 Power supply

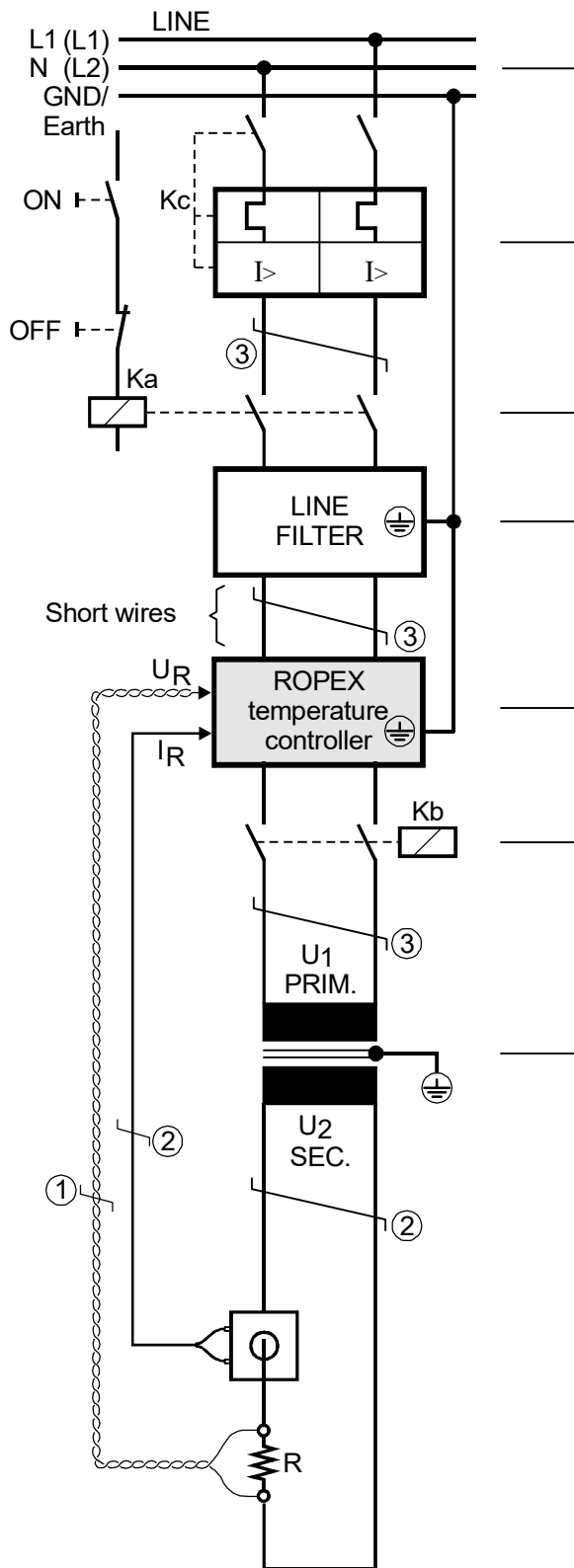

Line

Over-current protection

Double-pole circuit-breaker or fuses (☞ ROPEX Application Report).

⚠ Short-circuit protection only. CIRUS® temperature controller not protected.

Relay Ka

For "HEAT ON - OFF" function (all-pole) or "EMERGENCY STOP".

Line filter

The filter type and size must be determined according to the load, the transformer and the machine wiring (☞ ROPEX Application Report).

⚠ Do not run the filter supply wires (line side) parallel to the filter output wires (load side).

CIRUS® temperature controller

Relay Kb

Load break (all-pole), e.g. in combination with the alarm output of the temp. controller (ROPEX recommendation).

⚠ When using a series resistor RV-....-1 the relay Kb shall be installed.

Impulse Transformer

Designed according to EN 61558 (isolating transformer with reinforced insulation). Connect core to ground.

⚠ Use transformers with a one section bobbin. The power, duty cycle and voltage values must be determined individually according to the application (☞ ROPEX Application Report and "Accessories" leaflet for impulse transformers).

Wiring

The wire cross-sections depend on the application (☞ ROPEX Application Report).

- ① Wires must always be twisted (min. 20 turns/meter).
- ② These wires must be twisted (min. 20 turns/meter) if several control loops are laid together ("crosstalk").
- ③ Twisting (min. 20 turns/meter) is recommended to improve EMC.

6.4 Line filter

To comply with EMC directives – corresponding to EN 50081-1 and EN 50082-2 – CIRUS control loops must be operated with line filters.

These filters damp the reaction of the phase-angle control on the line and protect the controller against line disturbances.



The use of a suitable line filter is part of the standards conformity and a prerequisite of the CE mark.

ROPEX line filters are specially optimized for use in CIRUS control loops. Providing that they are installed and wired correctly, they guarantee compliance with the EMC limit values.

You can find the exact specification of the line filter in the ROPEX Application Report calculated for your particular heatsealing application.

For more technical information: ↪ "Line filter" documentation.

It is permissible to supply several CIRUS control loops with a single line filter, providing the total current does not exceed the maximum current of the filter.

The wiring instructions contained in section 6.3 "Power supply" on page 11 must be observed.

Example drawing for LF-06480:

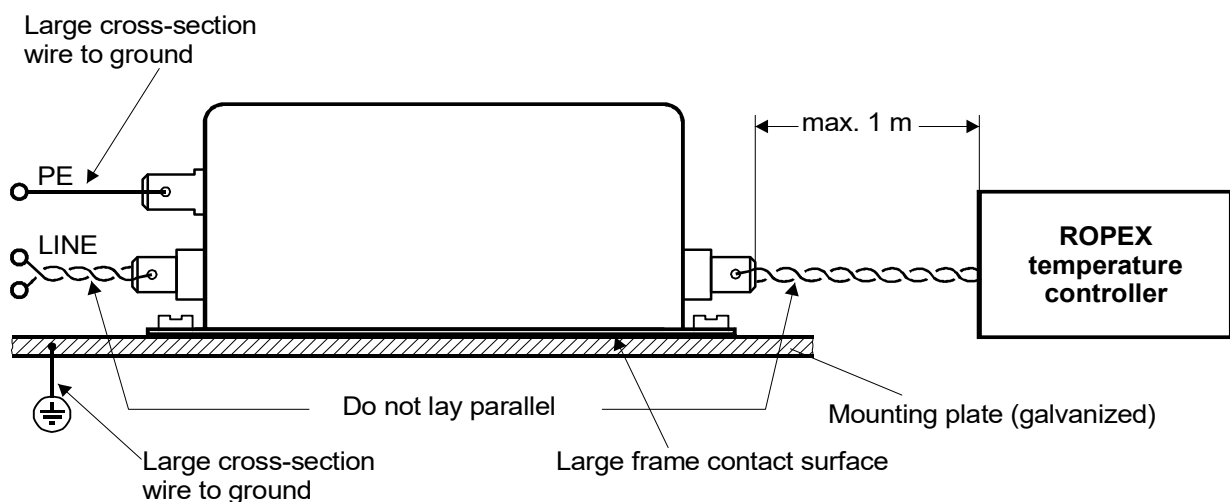

6.5 Current transformer PEX-W4/-W5

The PEX-W4/-W5 current transformer supplied with the CIRUS[®] temperature controller is an integral part of the control system. The current transformer may only be operated if it is connected to the temperature controller correctly (↪ section 6.3 "Power supply" on page 11).

6.5.1 PEX-W4

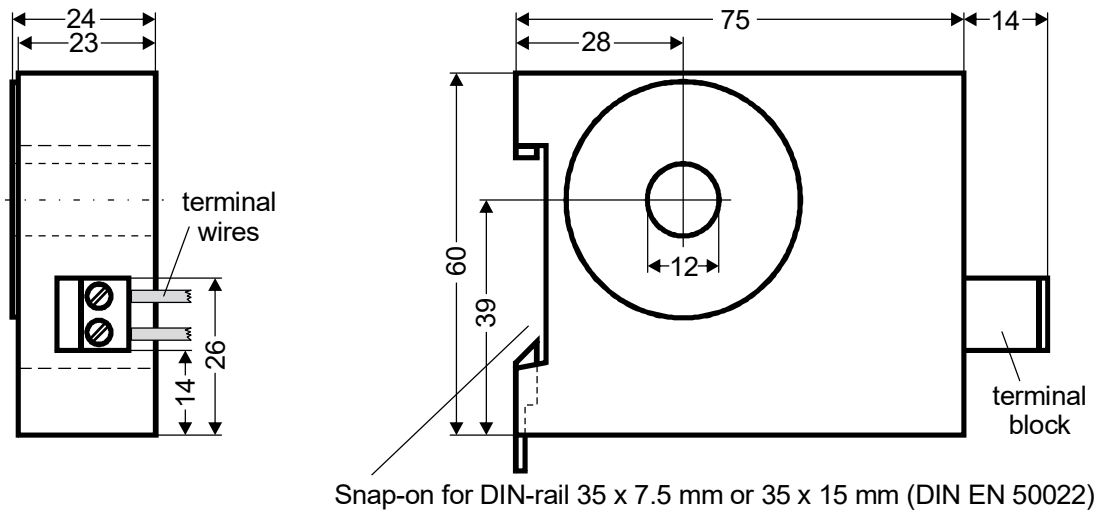

6.5.2 PEX-W5

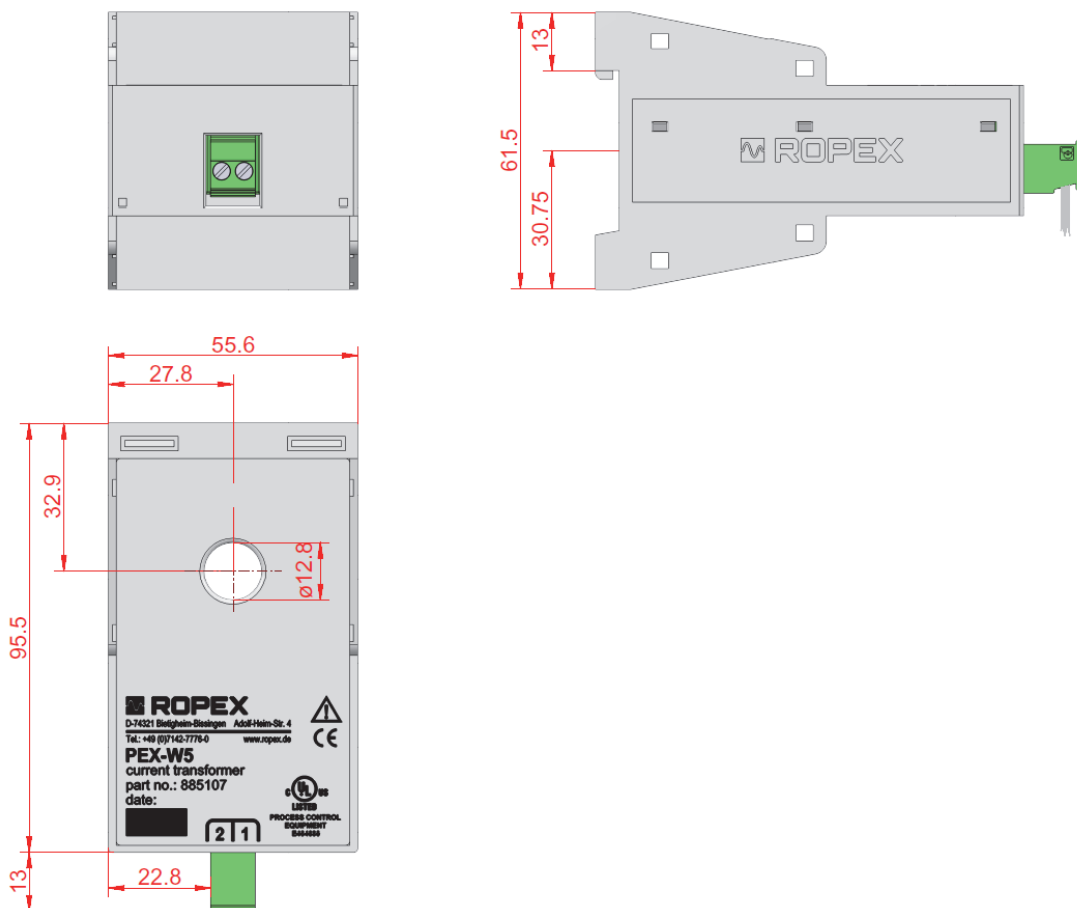

Mounting on DIN-rail 35 x 7.5 mm or 35 x 15 mm (DIN EN 50022).

6.6 Wiring diagram (standard)

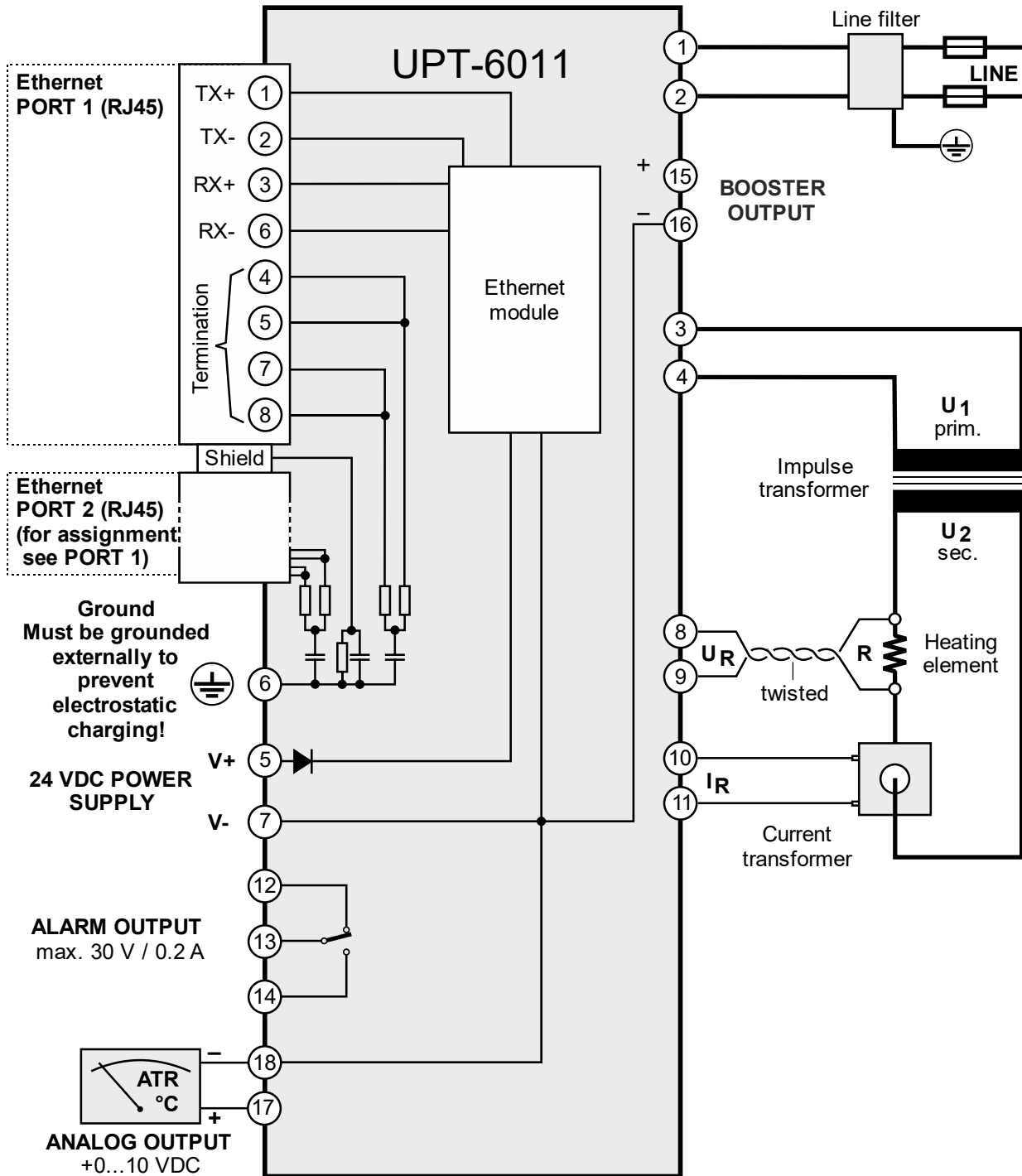

6.7 Wiring diagram with booster connection

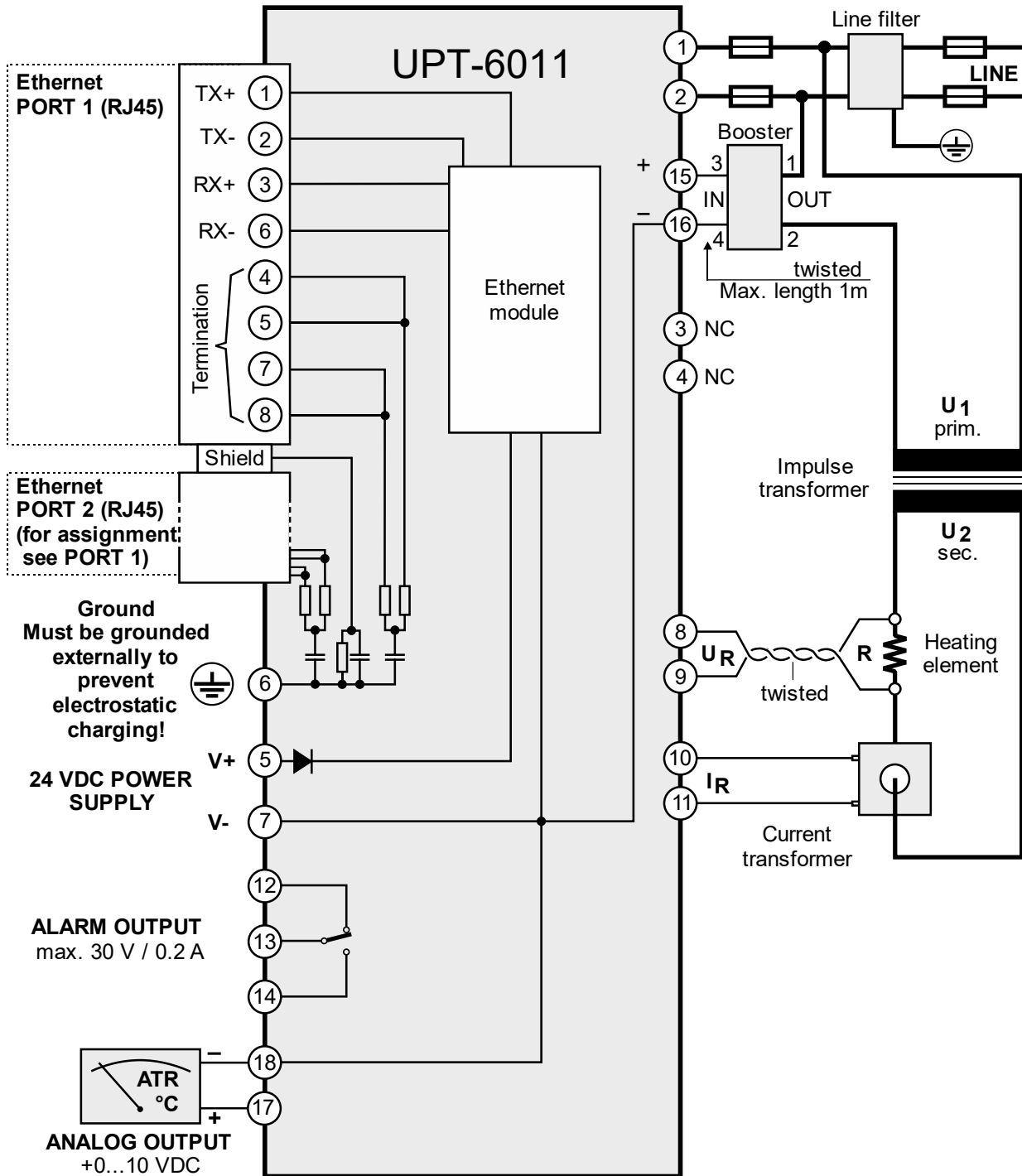

7 Startup and operation

7.1 View of the device

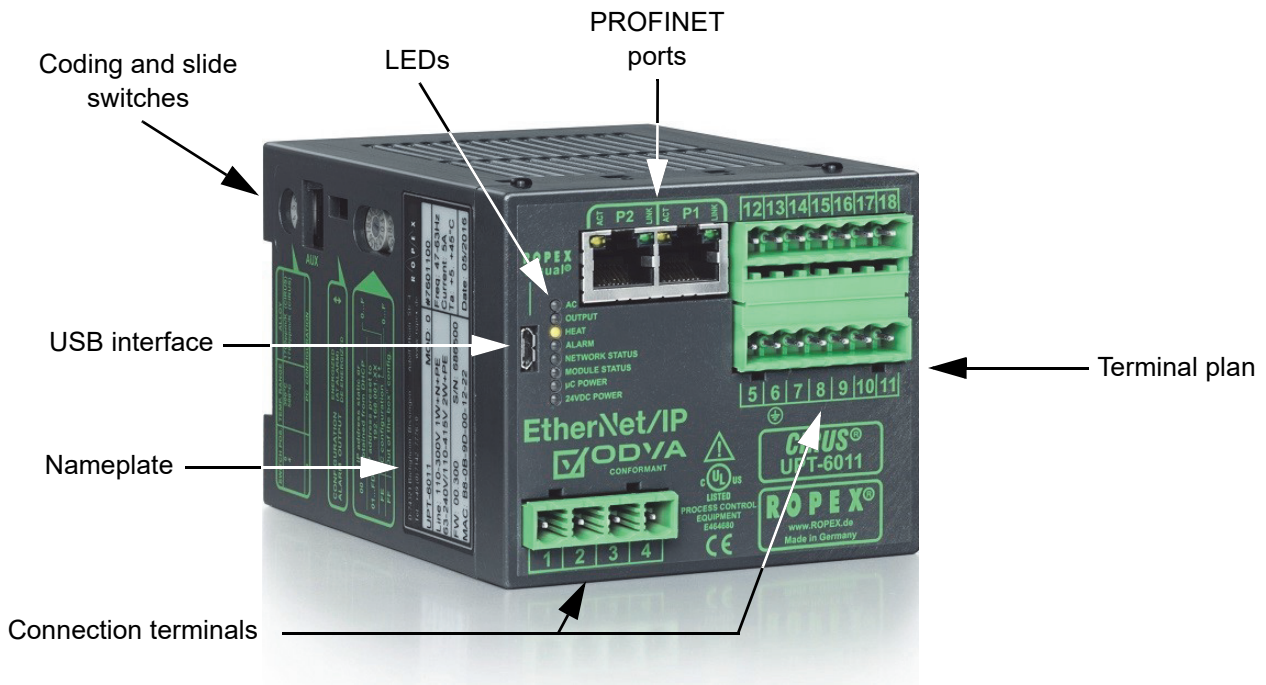

7.2 Device configuration

 **The controller must be switched off to configure the coding switch and the slide switch.**

7.2.1 Configuration of the secondary voltage and current ranges

The secondary voltage and current ranges are automatically configured during the automatic calibration function (AUTOCAL). The voltage is configured in the range from 0.4 VAC to 120 VAC and the current in the range from 30 A to 500 A. If the voltage and / or current are outside of the permissible range, a detailed error message appears on the controller (↪ section 8.19 "Error messages" on page 61).

If the secondary current I_2 is less than 30 A, the secondary high-current wire must be laid twice (or several times) through the PEX-W4 or PEX-W5 current transformer (↪ ROPEX Application Report).



7.2.2 Configuration of the rotary coding switch for the temperature range and alloy

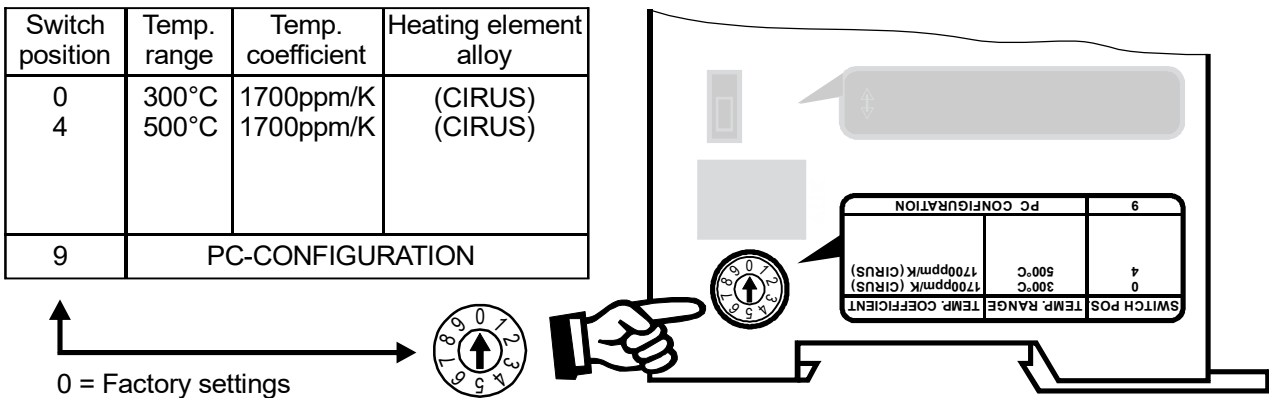

 **The setting of the rotary coding switch for the temperature range and alloy can be overwritten with the parameter data (↪ section 8.7 "Parameter object (class: 0x0F)" on page 28).**

If the switch is set to "9", more temperature ranges and alloys can be selected in the ROPEX visualization software (↪ section 8.12 "USB interface for visualization software ROPEXvisual®" on page 58).

7.2.3 Configuration of the rotary coding switch for the IP address

These coding switches allow you to set the least significant byte in the IP address of the UPT-6011 in the EtherNet/IP™ network to a value between 0x01 and 0xFD. A new setting does not take effect until the next time the controller is switched on. The preset IP address of the UPT-6011 is configured as follows, depending on the settings of the rotary coding switches:

Rotary coding switch	IP address
00	DHCP client active or if DHCP client was deactivated: Last IP address assigned is static
01...FD	192.168.001.1...253
FE	Configuration determined by PC visualization software
FF	Last configuration assigned is erased

IP address selectable.

00 = Factory settings

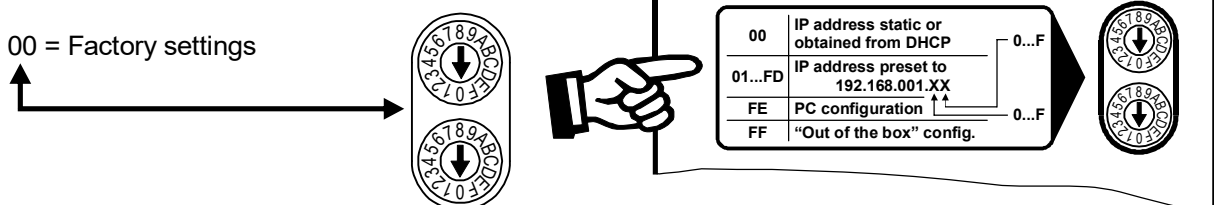

The "00" switch position allow an IP address to be assigned, or the DHCP client switched on and off, via the EtherNet/IP™ interface either using a software tool (e.g. Rockwell's "BOOT / P-DHCP Server") or by manually accessing the TCP / IP object. These settings are stored in the controller. However, when the power supply to the controller is momentarily interrupted, the stored values are only used if the rotary coding switches are set to "00". All other switch positions cause the stored values to be temporarily overwritten.

7.2.4 Configuration of the alarm relay

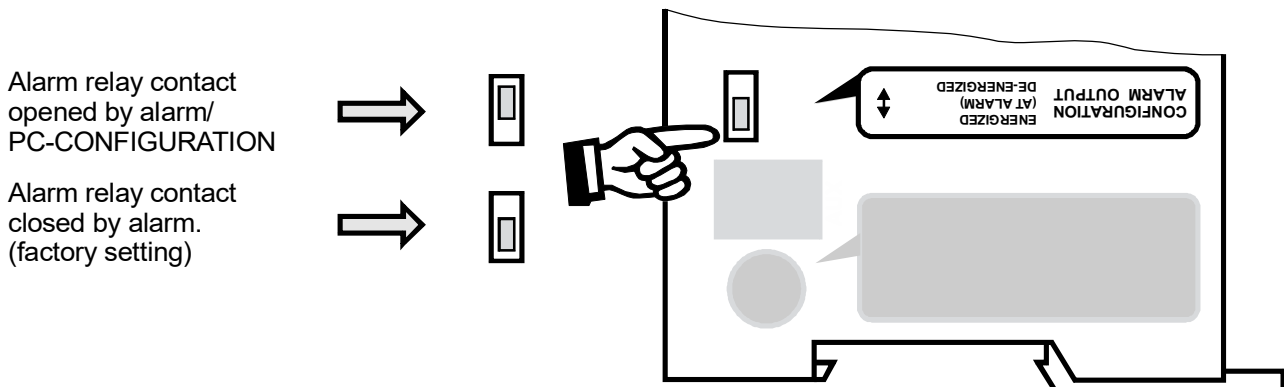

If the switch is set to "Alarm relay de-energized at alarm / PC CONFIGURATION", you can select more alarm output configurations in the ROPEX visualization software (↪ section 8.12 "USB interface for visualization software ROPEXvisual[®]" on page 58).

7.3 Heating element

7.3.1 General

The heating element is a key component in the control loop because it is not only a heating element but also a sensor. The geometry of the heating element is too complex to be discussed at length here. We shall therefore only refer to a few of the most important physical and electrical properties.

The measuring principle used for this system requires a heating element alloy with a suitable temperature coefficient TCR, i.e. one whose resistance increases as the temperature rises.

Too low a TCR leads to oscillation or uncontrolled heating.

If a heating element with a higher TCR is used, the controller must be calibrated for it.

The CIRUS[®] temperature controller is suitable for temperature coefficients in the range 400...4000 ppm/K.

⚠ The base resistance of the heating element increases continuously during operation (owing to the design). The "AUTOCAL" function must therefore be run again approximately every 100,000 heat-sealing cycles in order to prevent ACTUAL temperature measuring errors.

7.3.2 Replacing the heating element

⚠ The supply voltage (all poles) must be disconnected from the CIRUS[®] temperature controller in order to replace the heating element.

⚠ The heating element must be replaced in accordance with the instructions provided by the manufacturer.

Each time the heating element is replaced, you must run the "AUTOCAL" function (↪ section 8.5.1 "Automatic zero calibration AUTOCAL (AC)" on page 23) and set the correction factor Co (↪ section 8.7.8 "Correction factor Co" on page 49). Any production-related resistance tolerances of the heating element are compensated in this way.

7.4 Commissioning rules

Observe here section 2 "General information" on page 3 and section 3 "Application" on page 6.

⚠ Mounting, installation and commissioning may only be performed by qualified and trained persons who are familiar with the related hazards and warranty stipulations.

7.4.1 Initial startup

Requirement: Device is correctly mounted and connected (↪ section 6 "Mounting and installation" on page 9). Proceed as follows when starting up the controller for the first time:

1. Switch off network voltage and 24 VDC power supply; verify lack of voltage.
2. Either set the desired device IP address with the rotary coding switches or assign it using a DHCP server (↪ section 7.2 "Device configuration" on page 16).
3. Link the device description file (EDS) into the EtherNet/IP™ scanner (↪ section 8.3), then select the required parameters, make the connections, assign an IP address, and start the communication.
4. Make sure that the higher-level controller does not send values not equal to zero to the CIRUS® temperature controller.
5. Switch on the line voltage and the 24 VDC auxiliary supply (the order is arbitrary).
6. When the voltage is switched on, the yellow "AUTOCAL" LED lights up for approximately 0.3 seconds to indicate that the controller is being powered up correctly.

⚠ If the red "ALARM" LED lights up for 0.3...1.5 s when the voltage is switched on in addition to the yellow "AUTOCAL" LED, the configuration of this controller has been changed in the visualization software (↪ section 8.12 "USB interface for visualization software ROPEXvisual®" on page 58). In order to avoid malfunctions, please check the controller configuration before continuing the startup procedure.

7. One of the following states then appears:

"ALARM" LED	"OUTPUT" LED	ACTION
OFF	Short impulses every 0.4 seconds	Go to step 8
BLINKS fast (4 Hz)	OFF	Go to step 8
LIT continuously	OFF	Error diagnosis (↪ section 8.19)

8. Activate the AUTOCAL function while the heating element is still cold by setting the AC bit (**AUTOCAL**) in the EtherNet/IP™ protocol (↪ section 8.4 "Communication protocol" on page 22). The yellow "AUTOCAL" LED lights up for the duration of the calibration process (approx. 10...15 s). The AA bit (**AUTOCAL active**) is additionally set and a voltage of 0 VDC appears at the actual value output (terminals 17+18). If an ATR-x is connected, it indicates 0...3 °C.

After the zero point has been calibrated, the "AUTOCAL" LED goes out and the AA bit is reset. A voltage of 0.66 VDC (300 °C range and AUTOCAL temperature = 20 °C) or 0.4 VDC (500 °C range) appears at the actual value output. If an ATR-x is connected, it must be set to "Z".

If the zero point was not calibrated successfully, the AL bit (**alarm active**) is set and the red "ALARM" LED blinks slowly (1 Hz). In this case the controller configuration is incorrect (↪ section 7.2 "Device configuration" on page 16, ROPEX Application Report). Repeat the calibration after correcting the controller configuration.

9. After the zero point has been successfully calibrated, specify a defined temperature by means of the EtherNet/IP™ protocol (set point) and set the ST bit. The RA bit (**control active**) is then activated and the "HEAT" LED lights up. The heating and control process can be observed at the actual value output.

The controller is functioning correctly if the temperature (which corresponds to the signal change at the analog output or the actual value in the EtherNet/IP™ protocol) is a regular curve, in other words it must not jump

abruptly, fluctuate, or temporarily deviate in the wrong direction. This kind of behaviour would indicate that the U_R measurement cable was laid incorrectly.

If an error code is displayed, proceed as described in section 8.19 "Error messages" on page 61.

- Optimize the heating and control process either by adjusting the correction factor C_o in the parameter data (EDS file) or using the parameter object (↪ section 8.7.8 "Correction factor C_o " on page 49). Any production-related resistance tolerances of the heating element are compensated in this way.

8 Device functions

See also section 6.6 "Wiring diagram (standard)" on page 14.

8.1 LEDs and controls

RX/TX (yellow LED)	Lit or blinking if Ethernet frames are transmitted.
LINK (green LED)	Lit if connection exists to Ethernet.

AUTOCAL (yellow LED)	Lit while AUTOCAL process is executing.
OUTPUT (green LED)	Indicates pulses in measurement mode. In control mode, luminous intensity is proportional to heating current.
HEAT (yellow LED)	Lit during heating phase.
ALARM (Red LED)	Lit or blinking to indicate fault.

NETWORK STATUS (red/green)	Lit (green) if connection exists to EtherNet/IP scanner; lit (red) to indicate network error.
MODULE STATUS (red/green)	Lit (green) if there are no communication errors.
µC POWER (green LED)	Lit if internal power supply for EtherNet/IP interface is OK.
24 V POWER (green LED)	Lit if external 24 VDC power supply is present.

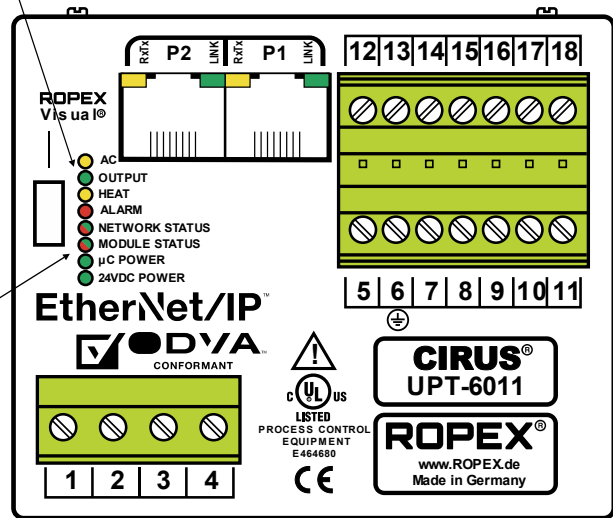

In addition to the functions shown above, the LEDs also indicate various controller operating states. These states are described in detail in the table below:

LED	Blinks slowly (1 Hz)	Blinks fast (4 Hz)	Lit continuously
AUTOCAL (yellow)	RS bit set (reset)	AUTOCAL requested but function blocked (e.g. START active)	AUTOCAL executing
	LED blinks at a different frequency: Supply voltages incorrect (too low)		
HEAT (yellow)	—	START requested but function blocked (e.g. AUTOCAL active, set temperature < 40 °C)	START executing
OUTPUT (green)	In control mode, luminous intensity is proportional to heating current.		
ALARM (red)	Configuration error, no AUTOCAL possible	Controller calibrated incorrectly, run AUTOCAL	Error, ↗ section 8.19
MODULE STATUS	Green: Standby Red: Warning, e.g. rotary coding switch setting changed	Red / green: Self-test	Green: Normal operation Red: Serious communication error
NETWORK STATUS	Green: No connection but IP address received Red: Connection timeout	Red / green: Self-test	Green: At least one connection to scanner Red: IP address of controller already assigned
LINK PORT 1, 2 (green)	—	—	Connection exists to Ethernet
RX / TX PORT 1, 2 (yellow)	Device is transmitting / receiving Ethernet frames		

8.2 EtherNet/IP™ communication

The following sections only describe controller-specific functions. For general information on the EtherNet/IP™ interface and the system configuration, please refer to the description of your PLC.

The controller can communicate via the EtherNet/IP™ interface provided the 24 VDC supply voltage (terminals 5+7) is present.

As long as no line voltage is present, the controller remains in an inactive status.

But interruption of the line voltage (e.g. by being switched off when a door is opened) triggers the error message 201 (error group no. 7, network voltage/sync signal is missing) and the Alarm relay switches. This is caused by the lack of line voltage. The error message can be reset by switching on the line voltage again and setting the RS bit (↗ section 8.5.3 "Reset (RS)" on page 24).

You can easily process the error code that appears if the line voltage is switched off – or suppress switching of the alarm relay – in the PLC program.

8.3 Device description file (EDS)

The configuring tools for the EtherNet/IP™ scanner interpret the content of the device description file (EDS) and use this information to create a parameter set for the EtherNet/IP™ scanner which controls user data traffic. The ROPEX_UPT-6011_V2_4.eds file of the UPT-6011 contains all essential controller information for the configuration, e.g. the I/O data description, parameter descriptions etc. The device description files and the associated image files (.BMP and .ICO) can be requested by e-mail (support@ropex.de) or downloaded from our website (<https://ropex.de>).

If the controller already has an IP address, the device description file can also be downloaded from the integrated web server. Alternatively, you can download it from the controller via the file object using CIP services.

After linking the required device description file into the configuring tool, you must assign an IP address to the controller. DHCP is activated by default to enable the controller to request an IP address from a DHCP server in the network. You must also select the desired parameter values.

8.4 Communication protocol

The communication protocol consists of 2x16 bit input words and 3x16 bit output words (from the point of view of the controller). This protocol separates the set point and the actual value of the UPT-6011 from the status information and the control functions, to simplify decoding by the EtherNet/IP™ scanner.

Bits 0...7 form the low byte and bits 8...15 the high byte ("INTEL format").

The 2 x 16 bit **input data** contains the set point in word ① and the control functions in word ②:

①	Spare							Set point / AC temperature									
Name:	0	0	0	0	0	0	0										
Bit no.:	15	14	13	12	11	10	9	8	7	6	5	4	3	2	1	0	

②	Spare					Channel			Spare			Control function				
Name:	0	0	0	0	0	CH2	CH1	CH0	0	0	0	MA	MP	RS	ST	AC
Bit no.:	15	14	13	12	11	10	9	8	7	6	5	4	3	2	1	0

The 3 x 16 bit **output data** contains the actual value in word ①, the status information in word ②, and the error code in word ③:

①	Actual value (signed)															
Name:																
Bit no.:	15	14	13	12	11	10	9	8	7	6	5	4	3	2	1	0

②	Spare			Channel				Status information								
Name:	0	0	0	MU ¹	CH2	CH1	CH0	SA	IA	WA	AA	AG	AL	TE	TO	RA
Bit no.:	15	14	13	12	11	10	9	8	7	6	5	4	3	2	1	0

1. From firmware version 303

③		Error code															
Name:	0	0	0	0	0	0	0	A9	A8	A7	A6	A5	A4	A3	A2	A1	A0
Bit no.:	15	14	13	12	11	10	9	8	7	6	5	4	3	2	1	0	

8.5 Input data

The term "input data" refers to the data that is transferred from the EtherNet/IP™ scanner to the UPT-6011. It contains the set point as well as the control functions such as START or AUTOCAL for the UPT-6011. These functions are explained in the following.

8.5.1 Automatic zero calibration AUTOCAL (AC)

Owing to the automatic zero calibration (AUTOCAL) function, there is no need to adjust the zero point manually on the controller. This function adjusts the controller to the current and voltage signals present in the system and calibrates it to the value which is predefined in the parameter data (↪ section 8.7.4 "Variable calibration temperature" on page 48). If no parameter data is transferred by the EtherNet/IP™ scanner, the default value is 20 °C. Some EtherNet/IP™ scanners do not allow the parameter data to be changed during operation. In this case, the calibration temperature cannot be adapted to the actual ambient conditions in the machines.

The calibration temperature can thus be specified by means of the "Set point / AC temperature" input data whenever the zero point is calibrated, provided this is permitted in the parameter data (↪ section 8.7.4 "Variable calibration temperature" on page 48). You can specify it in the 0...+40 °C range. The specified calibration temperature must be entered in the "Set point / AC temperature" input data when the AUTOCAL function is activated (AC bit = 1). This specified value must not be changed until the "AUTOCAL" function has finished.

If the specified temperature is too high (greater than 40 °C) or if the specified value fluctuates, an error message appears (error codes 115 and 116; ↪ section 8.19 "Error messages" on page 61).

The AUTOCAL request (AC bit = 1) is executed by the controller provided the AUTOCAL function is not blocked. The automatic calibration takes around 10...15 seconds. The heating element is not heated during this period. The yellow LED on the front panel lights up while the AUTOCAL function is executing and the controller shows "AUTOCAL active" (AA bit = 1) in the output data. The actual value output (terminals 17+18) changes to 0...3 °C (corresponds to approx. 0 VDC).

If the temperature of the heating element fluctuates, the AUTOCAL function is executed a maximum of three times. If the function still cannot be executed successfully, an error message appears (↪ section 8.19 "Error messages" on page 61).



You should always wait for the heating element to cool down (to ambient temperature) before activating the AUTOCAL function.

Reasons for blocked AUTOCAL function:

1. An AUTOCAL request cannot be accepted until 10 seconds after the controller is switched on. During this time the controller shows "AUTOCAL blocked" (AG bit = 1) in the output data.
2. The AUTOCAL function is not activated if the heating element cools down at a rate of more than 0.1 K/s. If the AC bit is set, the function is automatically executed when the cooling rate falls below the specified value.
3. If the START bit is set (ST bit = 1), the AUTOCAL function is not executed ("HEAT" LED lit).
4. If the RESET bit is set (RS bit = 1), the AUTOCAL function is not executed.
5. The AUTOCAL function cannot be activated if error codes 101...103, 201...203 or 9xx appear as soon as the controller is switched on (↪ section 8.19 "Error messages" on page 61). It also cannot be activated if error codes 201...203 or 9xx appear and the controller has operated correctly at least once since being switched on.

If the AUTOCAL function is blocked (AG bit = 1), an AUTOCAL request (AC bit = 1) causes the "AUTOCAL" LED to blink fast (4 Hz).

 **The base resistance of the heatsealing element increases during the operation continuously (determined by the design). Therefore the AUTOCAL function must be performed approximately every 100 000 sealing cycles to prevent measurement errors of the ACTUAL temperature.**

8.5.2 Start (ST)

When the START bit is set (ST bit = 1), the controller's internal set / actual comparison is enabled and the heating element is heated to the SET temperature. It remains at this temperature either until the ST bit is reset or until the actual heating time exceeds the preset heating time limit (↪ section 8.7.5 "Heating time limit" on page 49).

The "HEAT" LED on the front panel of the UPT-6011 lights up continuously for the duration of the heating time. A start request is not processed as long as the AUTOCAL function is active, a fault is present on the controller, the set point is less than 20 °C higher than the calibration temperature, or the RS bit is set. In this case, the "HEAT" LED blinks.

The heatup process is terminated if the ST bit is reset or a communication error occurs.

The ST bit is only accepted if the AUTOCAL function is deactivated and there are no faults.

The alarm relay is switched if the ST bit is set while a warning with error code 104...106, 111...114, 211, 302, or 303 is indicated (↪ section 8.19 "Error messages" on page 61). The heating element is not heated.

8.5.3 Reset (RS)

This bit resets the controller if the controller shows a fault.

No AUTOCAL or START requests are accepted as long as the RS bit is set. Until it is reset again, only error codes 201...203, 901, 913 are evaluated and output by the error diagnosis function. The power unit is not activated in this state and no measuring impulses are generated. As a result of this, the actual value is no longer updated. The reset request is not accepted until the RS bit is reset. EtherNet/IP™ Communications are not interrupted by a controller reset.

The controller actual value output changes to 0...3 °C (i.e. approximately 0 VDC) and the SA bit is set in order to set the RS bit.

The AUTOCAL function is not cancelled if the RS bit is set while it is executing.

The controller performs an internal initialization lasting approximately 500 ms after the RS bit is reset. The next heatsealing process cannot be started until it has finished.

If a Kb contactor is used to deactivate the control loop (↪ section 6.3 "Power supply" on page 11), it must be reliably energized again 200 ms at the latest after the RS bit is reset (note the contactor switching and delay times). If it is energized too late, an error message appears on the controller.

8.5.4 Measurement pause (MP)

No more measuring impulses are generated by the controller as soon as the MP bit is set. Until it is reset again, only error codes 201...203, 901, 913 are evaluated and output by the error diagnosis function. In addition, the actual value is no longer updated. The last valid value before the bit was set is output. As soon as the bit is reset, new measuring impulses are generated, all error messages are evaluated, and the actual value is updated again. This bit is only active in measurement mode. The bits ST, RS, and AC take priority.

The bit is suitable for all applications where the electrical connections of the heating element must be disconnected during normal operation without triggering a fault (e.g. sliding rail contacts).

Unlike the RS bit (RESET), the MP bit does not reset any faults when it is set. The controller is active again as soon as the bit is reset, in other words there is no initialization phase.

When the controller is switched on, it does not evaluate the MP bit until the system test (including the functional test of the heating circuit) has been successfully completed. This can take several hundred milliseconds.

8.5.5 Master AUTOCAL (MA)

Setting this control bit starts a calibration as described in section 8.5.1 "Automatic zero calibration AUTOCAL (AC)" on page 23. However, if the AUTOCAL function is successful, the heating element resistance which is determined by the controller is also used as a reference value, e.g. after replacing the heating element.

This reference value serves to calculate the deviation from the calibration value for all subsequent calibrations (initiated with the AC bit). This deviation helps you assess aging of the heating element. The deviation from the calibration value is queried by means of the parameter object.

8.5.6 Channel selection (CH0...CH2)

The temperature controller has separate memories for up to eight calibration data records. A calibration data record contains the values determined by the temperature controller during the "AUTOCAL" function. By storing the calibration data records, you can alternate between different sealing tools without having to run the AUTOCAL function every time the tool is changed. You only need to execute AUTOCAL if you connect a new heating element.

Since different calibration values, AUTOCAL temperatures, correction factors, and temperature coefficients are stored in the controller for this purpose, the required calibration data record 0...7 can be selected with the three bits CH0...CH2. You can switch to another channel at any time.

This function is useful, for instance, in applications where frequent changes of format are necessary. The tools can then be changed as required in order to handle the different formats. A channel containing the relevant calibration data record is assigned to each tool. Once all tools have been calibrated with a unique channel assignment, they can be changed at any time simply by selecting the appropriate channel.

If the application does not require any format changes, the channel can remain set to 0. In this case, the temperature controller behaves in exactly the same way as older models where different calibration data records are not supported.

It is possible to switch to another channel during the "AUTOCAL" function; however, the controller continues working with the original channel until the "AUTOCAL" function has finished. The channel currently being used by the controller is shown in the status information.

8.5.7 Set point

A set point of up to 300 °C or 500 °C is allowed, depending on the selected temperature range (↪ section 8.7.1 "Temperature range and alloy" on page 48). If you attempt to enter a higher set point, it is limited internally to 300 °C or 500 °C.

8.6 Output data

The term "output data" refers to the data that is transferred from the UPT-6011 to the EtherNet/IP™ scanner. It contains the current actual value as well as all important information on the current status of the controller. If a fault is signalled, it can be diagnosed accurately with the help of the error code.

8.6.1 AUTOCAL active (AA)

The "AA bit indicates that the AUTOCAL function is executing.

8.6.2 AUTOCAL blocked (AG)

If the AG bit is set, the AUTOCAL function is temporarily blocked. This is the case if "START" is active or the heating element is still in the cooling phase.

8.6.3 Alarm active (AL)

If the AL bit is set, an alarm has been triggered but not yet reset. The error code provides information on the exact cause (↪ section 8.19 "Error messages" on page 61).

8.6.4 Warning active (WA)

This bit can be set in addition to the AL bit. If the WA bit is set, a warning is output to indicate the current fault. In this case, the alarm relay is not active.

8.6.5 Temperature achieved (TE)

The TE bit is set if the actual temperature exceeds 95% of the set temperature. This status bit is reset again as soon as you exit control mode (ST bit = 0) or a fault is signalled (AL bit = 1).

8.6.6 Temperature OK (TO)

The UPT-6011 checks whether the actual temperature is within a settable tolerance band ("OK" window) either side of the set temperature. The high ($\Delta\vartheta_{high}$) and low ($\Delta\vartheta_{low}$) limits of the tolerance band can be changed independently of one another in the parameter data (↪ section 8.7 "Parameter object (class: 0x0F)" on page 28). The following settings are possible:

1. **"Off"**

The TO bit is always reset.

2. **"Active when Tact = Tset" (factory setting)**

The TO bit is set if the actual value is inside the specified temperature tolerance band. If the actual temperature is outside of the tolerance band, the TO bit is reset (see graph below).

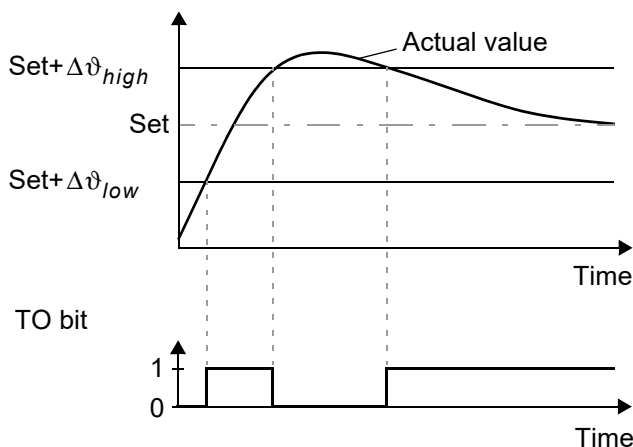

Unlike the "Temperature achieved" status bit (TE bit), the actual temperature is evaluated independently of the control mode.

3. **"Active when Tact = Tset" with latch function**

A heatsealing cycle starts when the ST bit is set. The TO bit is set when the actual temperature reaches the temperature tolerance band for the first time during a heatsealing cycle. If the actual temperature leaves the tolerance band again while the ST bit is still set, the TO bit is reset (Fig. a.). If the actual temperature does not leave the tolerance band while the ST bit is still set, the TO bit is not reset until the start of the next heatsealing cycle (latch function, Fig. b.). The switching state of the TO bit can thus be queried after the ST bit has been reset and before the start of the next heatsealing cycle.

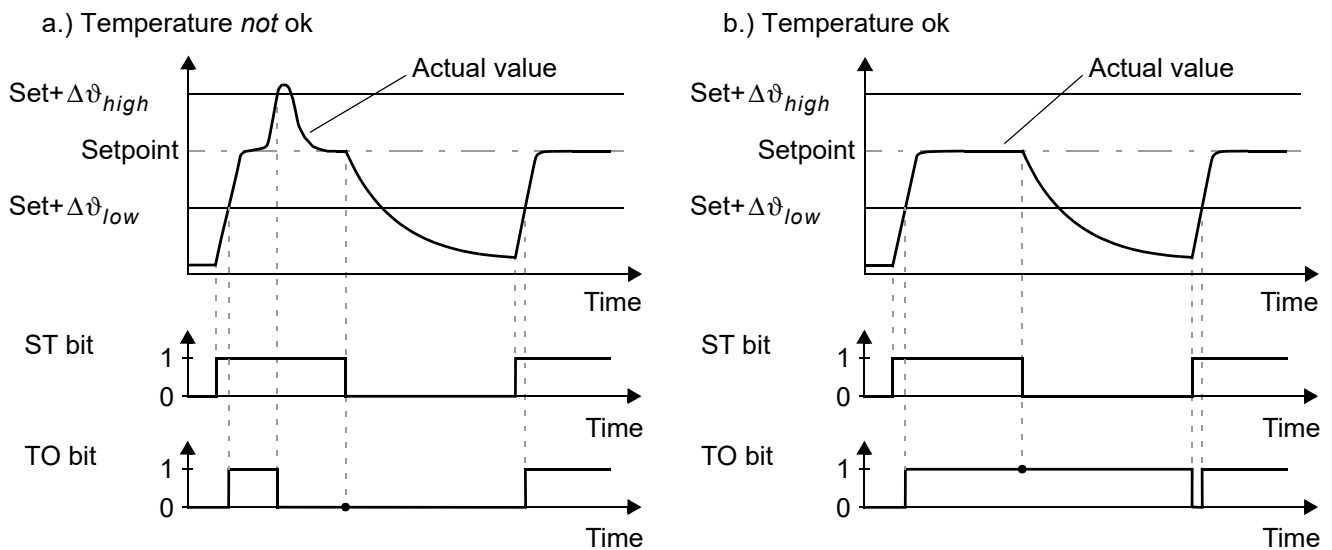

 The limits of the tolerance band are adjustable up to a maximum of ± 99 K.

8.6.7 Control active (RA)

The UPT-6011 has successfully accepted the "START" request and entered control mode if the RA bit = 1.

8.6.8 Info active (IA)

This bit is reserved for future use and is not currently supported (it is always set to 0).

8.6.9 Standby active (SA)

This bit is active if the RS bit is set. It shows the PLC when the controller has accepted the RS_bit or the MP bit, so that these bits can be reset again (handshake).

8.6.10 Measurement interruption (MU)

 This bit is available as from firmware version 303.

This bit is active as long as the controller does not perform a temperature measurement during the regulation phase ($ST = 1$). This can occur when the actual value is larger than the setpoint value (setpoint exceeded). This can be used, for example, to evaluate whether measurement interruptions occur during the heating impulse. This would then be an indication of excessive temperature, which can result in a bad sealing seam. As soon as a measurement is performed again, the MU bit goes back to 0.

8.6.11 Actual value

8.6.12 All 16 bits of the first word must be interpreted as a signed number (twos complement notation). The resolution is 1 °C. During the calibration procedure or if a fault occurs, the actual value is 0.**Error codes**

If a fault is signalled (AL bit = 1), you can determine the exact cause with the help of the error code. The error code is contained in the third word at bit positions 0...9 ( section 8.19 "Error messages" on page 61).

8.7 Parameter object (class: 0x0F)

In accordance with the CIP specification, the UPT-6011 provides a parameter object containing all of the device parameters.

All instances of the parameter object support the "Get_Attribute_Single" and "Get_Attribute_All" services. The class (instance 0) additionally supports the "Save", "Restore", and "Reset" services. The instances additionally support the "Set_Attribute_Single" service for attribute 1. The parameter object has the following structure:

Instance	Attribute ID	Data type ¹	Name	Default value	Value range
0 (class)	1	UINT	Revision	1	
	2	UINT	Max. instance	78	
	6	UINT	Max. class attribute	9	
	7	UINT	Max. instance attribute	6	
	8	UINT	Parameter class description	13	
	9	UINT	Configuration assembly	102	
1	1	USINT	Temperature range / alloy	10	0, 4, 9, 10, 11 (↪ 8.7.1)
	2	USINT	Link path length	6	
	3	EPATH	Link path	20 0F 24 01 30 01	
	4	WORD	Descriptor	0x0000	
	5	USINT	Data type	0xC6	
	6	USINT	Data length	1	
2	1	USINT	Low temperature OK threshold	10 K	3...99 K
	2	USINT	Link path length	6	
	3	EPATH	Link path	20 0F 24 02 30 01	
	4	WORD	Descriptor	0x0000	
	5	USINT	Data type	0xC6	
	6	USINT	Data length	1	
3	1	USINT	High temperature OK threshold	10 K	3...99 K
	2	USINT	Link path length	6	
	3	EPATH	Link path	20 0F 24 03 30 01	
	4	WORD	Descriptor	0x0000	
	5	USINT	Data type	0xC6	
	6	USINT	Data length	1	

Instance	Attribute ID	Data type ¹	Name	Default value	Value range
4	1	SINT	Calibration temperature	20 °C	-1 (= variable), 0...40 °C
	2	USINT	Link path length	6	
	3	EPATH	Link path	20 0F 24 04 30 01	
	4	WORD	Descriptor	0x0000	
	5	USINT	Data type	0xC2	
	6	USINT	Data length	1	
5	1	UINT	Heating time limit (10 ms steps)	500 (5.00 s)	0...999 (0...9.99 s)
	2	USINT	Link path length	6	
	3	EPATH	Link path	20 0F 24 05 30 01	
	4	WORD	Descriptor	0x0004 (scaling supported)	
	5	USINT	Data type	0xC7	
	6	USINT	Data length	2	
	13	USINT	Factor	1	
	14	USINT	Divisor	100	
	15	USINT	Base	1	
	16	USINT	Offset	0	
6	1	USINT	Measuring impulse duration	1.7 ms (17)	1.7...3.0 ms (17...30)
	2	USINT	Link path length	6	
	3	EPATH	Link path	20 0F 24 06 30 01	
	4	WORD	Descriptor	0x0004 (scaling supported)	
	5	USINT	Data type	0xC6	
	6	USINT	Data length	1	
	13	USINT	Factor	1	
	14	USINT	Divisor	10	
	15	USINT	Base	1	
	16	USINT	Offset	0	

Instance	Attribute ID	Data type ¹	Name	Default value	Value range
7	1	BOOL	Data format	Little Endian, Intel (0)	Little Endian, Intel (0), Big Endian, Motorola (1)
	2	USINT	Link path length	6	
	3	EPATH	Link path	20 0F 24 07 30 01	
	4	WORD	Descriptor	0x0000	
	5	USINT	Data type	0xC1	
	6	USINT	Data length	1	
8	1	UINT	Correction factor	100	25...200%
	2	USINT	Link path length	6	
	3	EPATH	Link path	20 0F 24 08 30 01	
	4	WORD	Descriptor	0x0000	
	5	USINT	Data type	0xC7	
	6	USINT	Data length	2	
9	1	UINT	Maximum start temperature	100	20...500 °C
	2	USINT	Link path length	6	
	3	EPATH	Link path	20 0F 24 09 30 01	
	4	WORD	Descriptor	0x0000	
	5	USINT	Data type	0xC7	
	6	USINT	Data length	2	
10	1	UINT	Temperature coefficient	1700 ppm/K	400...4000 ppm/K
	2	USINT	Link path length	6	
	3	EPATH	Link path	20 0F 24 0A 30 01	
	4	WORD	Descriptor	0x0000	
	5	USINT	Data type	0xC7	
	6	USINT	Data length	2	

Instance	Attribute ID	Data type ¹	Name	Default value	Value range
11	1	USINT	Temperature range	1 (300 °C)	0 (200 °C), 1 (300 °C), 2 (400 °C), 3 (500 °C)
	2	USINT	Link path length	6	
	3	EPATH	Link path	20 0F 24 0B 30 01	
	4	WORD	Descriptor	0x0000	
	5	USINT	Data type	0xC6	
	6	USINT	Data length	1	
12	1	UINT	Maximum temperature	300 °C	200...500 °C
	2	USINT	Link path length	6	
	3	EPATH	Link path	20 0F 24 0C 30 01	
	4	WORD	Descriptor	0x0000	
	5	USINT	Data type	0xC7	
	6	USINT	Data length	2	
13	1	BOOL	Temperature diagnosis	Off (0)	Off (0), on (1)
	2	USINT	Link path length	6	
	3	EPATH	Link path	20 0F 24 0D 30 01	
	4	WORD	Descriptor	0x0000	
	5	USINT	Data type	0xC1	
	6	USINT	Data length	1	
14	1	UINT	Temperature diagnosis delay (10 ms steps)	0 s	0...999 (0...9.99 s)
	2	USINT	Link path length	6	
	3	EPATH	Link path	20 0F 24 0E 30 01	
	4	WORD	Descriptor	0x0004 (scaling supported)	
	5	USINT	Data type	0xC7	
	6	USINT	Data length	2	
	13	USINT	Factor	1	
	14	USINT	Divisor	100	
	15	USINT	Base	1	
	16	USINT	Offset	0	

Instance	Attribute ID	Data type ¹	Name	Default value	Value range
15	1	UINT	Heatup timeout (10 ms steps)	0 s	0...999 (0...9.99 s)
	2	USINT	Link path length	6	
	3	EPATH	Link path	20 0F 24 0F 30 01	
	4	WORD	Descriptor	0x0004 (scaling supported)	
	5	USINT	Data type	0xC7	
	6	USINT	Data length	2	
	13	USINT	Factor	1	
	14	USINT	Divisor	100	
	15	USINT	Base	1	
16	USINT	Offset	0		
16	1	USINT	Temperature OK bit	Active when Tact=Tset	Off (0), active when Tact=Tset (1), active when Tact=Tset with latch (2)
	2	USINT	Link path length	6	
	3	EPATH	Link path	20 0F 24 10 30 01	
	4	WORD	Descriptor	0x0000	
	5	USINT	Data type	0xC6	
	6	USINT	Data length	1	
17	1	USINT	Hold mode	Off	Off (0), on (1), 2 s (2)
	2	USINT	Link path length	6	
	3	EPATH	Link path	20 0F 24 11 30 01	
	4	WORD	Descriptor	0x0000	
	5	USINT	Data type	0xC6	
	6	USINT	Data length	1	

Instance	Attribute ID	Data type ¹	Name	Default value	Value range
18	1	SINT	Calibration temperature, channel 1	20 °C	-1 (= variable), 0...40 °C
	2	USINT	Link path length	6	
	3	EPATH	Link path	20 0F 24 12 30 01	
	4	WORD	Descriptor	0x0000	
	5	USINT	Data type	0xC2	
	6	USINT	Data length	2	
19	1	UINT	Correction factor, channel 1	100	25...200%
	2	USINT	Link path length	6	
	3	EPATH	Link path	20 0F 24 13 30 01	
	4	WORD	Descriptor	0x0000	
	5	USINT	Data type	0xC7	
	6	USINT	Data length	2	
20	1	UINT	Temperature coefficient, channel 1	1700 ppm/K	400...4000 ppm/K
	2	USINT	Link path length	6	
	3	EPATH	Link path	20 0F 24 14 30 01	
	4	WORD	Descriptor	0x0000	
	5	USINT	Data type	0xC7	
	6	USINT	Data length	2	
21	1	SINT	Calibration temperature, channel 2	20 °C	-1 (= variable), 0...40 °C
	2	USINT	Link path length	6	
	3	EPATH	Link path	20 0F 24 15 30 01	
	4	WORD	Descriptor	0x0000	
	5	USINT	Data type	0xC2	
	6	USINT	Data length	1	
22	1	UINT	Correction factor, channel 2	100	25...200%
	2	USINT	Link path length	6	
	3	EPATH	Link path	20 0F 24 16 30 01	
	4	WORD	Descriptor	0x0000	
	5	USINT	Data type	0xC7	
	6	USINT	Data length	2	

Instance	Attribute ID	Data type ¹	Name	Default value	Value range
23	1	UINT	Temperature coefficient, channel 2	1700 ppm/K	400...4000 ppm/K
	2	USINT	Link path length	6	
	3	EPATH	Link path	20 0F 24 17 30 01	
	4	WORD	Descriptor	0x0000	
	5	USINT	Data type	0xC7	
	6	USINT	Data length	2	
24	1	SINT	Calibration temperature, channel 3	20 °C	-1 (= variable), 0...40 °C
	2	USINT	Link path length	6	
	3	EPATH	Link path	20 0F 24 18 30 01	
	4	WORD	Descriptor	0x0000	
	5	USINT	Data type	0xC2	
	6	USINT	Data length	1	
25	1	UINT	Correction factor, channel 3	100	25...200%
	2	USINT	Link path length	6	
	3	EPATH	Link path	20 0F 24 19 30 01	
	4	WORD	Descriptor	0x0000	
	5	USINT	Data type	0xC7	
	6	USINT	Data length	2	
26	1	UINT	Temperature coefficient, channel 3	1700 ppm/K	400...4000 ppm/K
	2	USINT	Link path length	6	
	3	EPATH	Link path	20 0F 24 1A 30 01	
	4	WORD	Descriptor	0x0000	
	5	USINT	Data type	0xC7	
	6	USINT	Data length	2	
27	1	SINT	Calibration temperature, channel 4	20 °C	-1 (= variable), 0...40 °C
	2	USINT	Link path length	6	
	3	EPATH	Link path	20 0F 24 1B 30 01	
	4	WORD	Descriptor	0x0000	
	5	USINT	Data type	0xC2	
	6	USINT	Data length	1	

Instance	Attribute ID	Data type ¹	Name	Default value	Value range
28	1	UINT	Correction factor, channel 4	100	25...200%
	2	USINT	Link path length	6	
	3	EPATH	Link path	20 0F 24 1C 30 01	
	4	WORD	Descriptor	0x0000	
	5	USINT	Data type	0xC7	
	6	USINT	Data length	2	
29	1	UINT	Temperature coefficient, channel 4	1700 ppm/K	400...4000 ppm/K
	2	USINT	Link path length	6	
	3	EPATH	Link path	20 0F 24 1D 30 01	
	4	WORD	Descriptor	0x0000	
	5	USINT	Data type	0xC7	
	6	USINT	Data length	2	
30	1	SINT	Calibration temperature, channel 5	20 °C	-1 (= variable), 0...40 °C
	2	USINT	Link path length	6	
	3	EPATH	Link path	20 0F 24 1E 30 01	
	4	WORD	Descriptor	0x0000	
	5	USINT	Data type	0xC2	
	6	USINT	Data length	1	
31	1	UINT	Correction factor, channel 5	100	25...200%
	2	USINT	Link path length	6	
	3	EPATH	Link path	20 0F 24 1F 30 01	
	4	WORD	Descriptor	0x0000	
	5	USINT	Data type	0xC7	
	6	USINT	Data length	2	
32	1	UINT	Temperature coefficient, channel 5	1700 ppm/K	400...4000 ppm/K
	2	USINT	Link path length	6	
	3	EPATH	Link path	20 0F 24 20 30 01	
	4	WORD	Descriptor	0x0000	
	5	USINT	Data type	0xC7	
	6	USINT	Data length	2	

Instance	Attribute ID	Data type ¹	Name	Default value	Value range
33	1	SINT	Calibration temperature, channel 6	20 °C	-1 (= variable), 0...40 °C
	2	USINT	Link path length	6	
	3	EPATH	Link path	20 0F 24 21 30 01	
	4	WORD	Descriptor	0x0000	
	5	USINT	Data type	0xC2	
	6	USINT	Data length	1	
34	1	UINT	Correction factor, channel 6	100	25...200%
	2	USINT	Link path length	6	
	3	EPATH	Link path	20 0F 24 22 30 01	
	4	WORD	Descriptor	0x0000	
	5	USINT	Data type	0xC7	
	6	USINT	Data length	2	
35	1	UINT	Temperature coefficient, channel 6	1700 ppm/K	400...4000 ppm/K
	2	USINT	Link path length	6	
	3	EPATH	Link path	20 0F 24 23 30 01	
	4	WORD	Descriptor	0x0000	
	5	USINT	Data type	0xC7	
	6	USINT	Data length	2	
36	1	SINT	Calibration temperature, channel 7	20 °C	-1 (= variable), 0...40 °C
	2	USINT	Link path length	6	
	3	EPATH	Link path	20 0F 24 24 30 01	
	4	WORD	Descriptor	0x0000	
	5	USINT	Data type	0xC2	
	6	USINT	Data length	1	
37	1	UINT	Correction factor, channel 7	100	25...200%
	2	USINT	Link path length	6	
	3	EPATH	Link path	20 0F 24 25 30 01	
	4	WORD	Descriptor	0x0000	
	5	USINT	Data type	0xC7	
	6	USINT	Data length	2	

Instance	Attribute ID	Data type ¹	Name	Default value	Value range
38	1	UINT	Temperature coefficient, channel 7	1700 ppm/K	400...4000 ppm/K
	2	USINT	Link path length	6	
	3	EPATH	Link path	20 0F 24 26 30 01	
	4	WORD	Descriptor	0x0000	
	5	USINT	Data type	0xC7	
	6	USINT	Data length	2	
39	1	DATE	Date (days since 1972-01-01)	01.01.2000	
	2	USINT	Link path length	6	
	3	EPATH	Link path	20 0F 24 27 30 01	
	4	WORD	Descriptor	0x0000	
	5	USINT	Data type	0xCD	
	6	USINT	Data length	2	
40	1	TIME_OF_DAY	Time (milliseconds since 00:00)	00:00:00:00	
	2	USINT	Link path length	6	
	3	EPATH	Link path	20 0F 24 28 30 01	
	4	WORD	Descriptor	0x0000	
	5	USINT	Data type	0xCE	
	6	USINT	Data length	4	
41	1	UDINT	Operating hours	0	0...9999999.9 h
	2	USINT	Link path length	6	
	3	EPATH	Link path	20 0F 24 29 30 01	
	4	WORD	Descriptor	0x0014	
	5	USINT	Data type	0xC8	
	6	USINT	Data length	4	
42	1	UDINT	Cycle counter (non-clearable)	0	0...99999999
	2	USINT	Link path length	6	
	3	EPATH	Link path	20 0F 24 2A 30 01	
	4	WORD	Descriptor	0x0010	
	5	USINT	Data type	0xC8	
	6	USINT	Data length	4	

Instance	Attribute ID	Data type ¹	Name	Default value	Value range
43	1	UDINT	Cycle counter (clearable)	0	0...99999999
	2	USINT	Link path length	6	
	3	EPATH	Link path	20 0F 24 2B 30 01	
	4	WORD	Descriptor	0x0000	
	5	USINT	Data type	0xC8	
	6	USINT	Data length	4	
44	1	UDINT	Cycle counter, channel 0	0	0...99999999
	2	USINT	Link path length	6	
	3	EPATH	Link path	20 0F 24 2C 30 01	
	4	WORD	Descriptor	0x0000	
	5	USINT	Data type	0xC8	
	6	USINT	Data length	4	
45	1	UDINT	Cycle counter, channel 1	0	0...99999999
	2	USINT	Link path length	6	
	3	EPATH	Link path	20 0F 24 2D 30 01	
	4	WORD	Descriptor	0x0000	
	5	USINT	Data type	0xC8	
	6	USINT	Data length	4	
46	1	UDINT	Cycle counter, channel 2	0	0...99999999
	2	USINT	Link path length	6	
	3	EPATH	Link path	20 0F 24 2E 30 01	
	4	WORD	Descriptor	0x0000	
	5	USINT	Data type	0xC8	
	6	USINT	Data length	4	
47	1	UDINT	Cycle counter, channel 3	0	0...99999999
	2	USINT	Link path length	6	
	3	EPATH	Link path	20 0F 24 2F 30 01	
	4	WORD	Descriptor	0x0000	
	5	USINT	Data type	0xC8	
	6	USINT	Data length	4	

Instance	Attribute ID	Data type ¹	Name	Default value	Value range
48	1	UDINT	Cycle counter, channel 4	0	0...99999999
	2	USINT	Link path length	6	
	3	EPATH	Link path	20 0F 24 30 30 01	
	4	WORD	Descriptor	0x0000	
	5	USINT	Data type	0xC8	
	6	USINT	Data length	4	
49	1	UDINT	Cycle counter, channel 5	0	0...99999999
	2	USINT	Link path length	6	
	3	EPATH	Link path	20 0F 24 31 30 01	
	4	WORD	Descriptor	0x0000	
	5	USINT	Data type	0xC8	
	6	USINT	Data length	4	
50	1	UDINT	Cycle counter, channel 6	0	0...99999999
	2	USINT	Link path length	6	
	3	EPATH	Link path	20 0F 24 32 30 01	
	4	WORD	Descriptor	0x0000	
	5	USINT	Data type	0xC8	
	6	USINT	Data length	4	
51	1	UDINT	Cycle counter, channel 7	0	0...99999999
	2	USINT	Link path length	6	
	3	EPATH	Link path	20 0F 24 33 30 01	
	4	WORD	Descriptor	0x0000	
	5	USINT	Data type	0xC8	
	6	USINT	Data length	4	
52	1	INT	Start temperature	-99	-99...500 °C
	2	USINT	Link path length	6	
	3	EPATH	Link path	20 0F 24 34 30 01	
	4	WORD	Descriptor	0x0010	
	5	USINT	Data type	0xC3	
	6	USINT	Data length	2	

Instance	Attribute ID	Data type ¹	Name	Default value	Value range
53	1	INT	Device temperature		-60...190 °C
	2	USINT	Link path length	6	
	3	EPATH	Link path	20 0F 24 35 30 01	
	4	WORD	Descriptor	0x0010	
	5	USINT	Data type	0xC3	
	6	USINT	Data length	2	
54	1	INT	Calibration deviation, channel 0	0	-100.00...100.00%
	2	USINT	Link path length	6	
	3	EPATH	Link path	20 0F 24 36 30 01	
	4	WORD	Descriptor	0x0010	
	5	USINT	Data type	0xC3	
	6	USINT	Data length	2	
55	1	INT	Calibration deviation, channel 1	0	-100.00...100.00%
	2	USINT	Link path length	6	
	3	EPATH	Link path	20 0F 24 37 30 01	
	4	WORD	Descriptor	0x0010	
	5	USINT	Data type	0xC3	
	6	USINT	Data length	2	
56	1	INT	Calibration deviation, channel 2	0	-100.00...100.00%
	2	USINT	Link path length	6	
	3	EPATH	Link path	20 0F 24 38 30 01	
	4	WORD	Descriptor	0x0010	
	5	USINT	Data type	0xC3	
	6	USINT	Data length	2	
57	1	INT	Calibration deviation, channel 3	0	-100.00...100.00%
	2	USINT	Link path length	6	
	3	EPATH	Link path	20 0F 24 39 30 01	
	4	WORD	Descriptor	0x0010	
	5	USINT	Data type	0xC3	
	6	USINT	Data length	2	

Instance	Attribute ID	Data type ¹	Name	Default value	Value range
58	1	INT	Calibration deviation, channel 4	0	-100.00...100.00%
	2	USINT	Link path length	6	
	3	EPATH	Link path	20 0F 24 3A30 01	
	4	WORD	Descriptor	0x0010	
	5	USINT	Data type	0xC3	
	6	USINT	Data length	2	
59	1	INT	Calibration deviation, channel 5	0	-100.00...100.00%
	2	USINT	Link path length	6	
	3	EPATH	Link path	20 0F 24 3B 30 01	
	4	WORD	Descriptor	0x0010	
	5	USINT	Data type	0xC3	
	6	USINT	Data length	2	
60	1	INT	Calibration deviation, channel 6	0	-100.00...100.00%
	2	USINT	Link path length	6	
	3	EPATH	Link path	20 0F 24 3C 30 01	
	4	WORD	Descriptor	0x0010	
	5	USINT	Data type	0xC3	
	6	USINT	Data length	2	
61	1	INT	Calibration deviation, channel 7	0	-100.00...100.00%
	2	USINT	Link path length	6	
	3	EPATH	Link path	20 0F 24 3D 30 01	
	4	WORD	Descriptor	0x0010	
	5	USINT	Data type	0xC3	
	6	USINT	Data length	2	
62	1	USINT	Passes through current transformer	1	1...9
	2	USINT	Link path length	6	
	3	EPATH	Link path	20 0F 24 3E 30 01	
	4	WORD	Descriptor	0x0000	
	5	USINT	Data type	0xC6	
	6	USINT	Data length	1	

Instance	Attribute ID	Data type ¹	Name	Default value	Value range
63	1	UINT	Calibration resistance, channel 0 (in 0.1 mΩ)	0 mΩ	0...65535 (0...6553.5 mΩ)
	2	USINT	Link path length	6	
	3	EPATH	Link path	20 0F 24 3F 30 01	
	4	WORD	Descriptor	0x0014 (scaling supported)	
	5	USINT	Data type	0xC7	
	6	USINT	Data length	2	
	13	USINT	Factor	1	
	14	USINT	Divisor	10	
	15	USINT	Basis	1	
	16	USINT	Offset	0	
64	1	UINT	Calibration resistance, channel 1 (in 0.1 mΩ)	0 mΩ	0...65535 (0...6553.5 mΩ)
	2	USINT	Link path length	6	
	3	EPATH	Link path	20 0F 24 40 30 01	
	4	WORD	Descriptor	0x0014 (scaling supported)	
	5	USINT	Data type	0xC7	
	6	USINT	Data length	2	
	13	USINT	Factor	1	
	14	USINT	Divisor	10	
	15	USINT	Basis	1	
	16	USINT	Offset	0	
65	1	UINT	Calibration resistance, channel 2 (in 0.1 mΩ)	0 mΩ	0...65535 (0...6553.5 mΩ)
	2	USINT	Link path length	6	
	3	EPATH	Link path	20 0F 24 41 30 01	
	4	WORD	Descriptor	0x0014 (scaling supported)	
	5	USINT	Data type	0xC7	
	6	USINT	Data length	2	
	13	USINT	Factor	1	
	14	USINT	Divisor	10	
	15	USINT	Basis	1	
	16	USINT	Offset	0	

Instance	Attribute ID	Data type ¹	Name	Default value	Value range
66	1	UINT	Calibration resistance, channel 3 (in 0.1 mΩ)	0 mΩ	0...65535 (0...6553.5 mΩ)
	2	USINT	Link path length	6	
	3	EPATH	Link path	20 0F 24 42 30 01	
	4	WORD	Descriptor	0x0014 (scaling supported)	
	5	USINT	Data type	0xC7	
	6	USINT	Data length	2	
	13	USINT	Factor	1	
	14	USINT	Divisor	10	
	15	USINT	Basis	1	
	16	USINT	Offset	0	
67	1	UINT	Calibration resistance, channel 4 (in 0.1 mΩ)	0 mΩ	0...65535 (0...6553.5 mΩ)
	2	USINT	Link path length	6	
	3	EPATH	Link path	20 0F 24 43 30 01	
	4	WORD	Descriptor	0x0014 (scaling supported)	
	5	USINT	Data type	0xC7	
	6	USINT	Data length	2	
	13	USINT	Factor	1	
	14	USINT	Divisor	10	
	15	USINT	Basis	1	
	16	USINT	Offset	0	
68	1	UINT	Calibration resistance, channel 5 (in 0.1 mΩ)	0 mΩ	0...65535 (0...6553.5 mΩ)
	2	USINT	Link path length	6	
	3	EPATH	Link path	20 0F 24 44 30 01	
	4	WORD	Descriptor	0x0014 (scaling supported)	
	5	USINT	Data type	0xC7	
	6	USINT	Data length	2	
	13	USINT	Factor	1	
	14	USINT	Divisor	10	
	15	USINT	Basis	1	
	16	USINT	Offset	0	

Instance	Attribute ID	Data type ¹	Name	Default value	Value range
69	1	UINT	Calibration resistance, channel 6 (in 0.1 mΩ)	0 mΩ	0...65535 (0...6553.5 mΩ)
	2	USINT	Link path length	6	
	3	EPATH	Link path	20 0F 24 45 30 01	
	4	WORD	Descriptor	0x0014 (scaling supported)	
	5	USINT	Data type	0xC7	
	6	USINT	Data length	2	
	13	USINT	Factor	1	
	14	USINT	Divisor	10	
	15	USINT	Basis	1	
	16	USINT	Offset	0	
70	1	UINT	Calibration resistance, channel 7 (in 0.1 mΩ)	0 mΩ	0...65535 (0...6553.5 mΩ)
	2	USINT	Link path length	6	
	3	EPATH	Link path	20 0F 24 46 30 01	
	4	WORD	Descriptor	0x0014 (scaling supported)	
	5	USINT	Data type	0xC7	
	6	USINT	Data length	2	
	13	USINT	Factor	1	
	14	USINT	Divisor	10	
	15	USINT	Basis	1	
	16	USINT	Offset	0	
71	1	UINT	Initial calibration resistance, channel 0 (in 0.1 mΩ)	0 mΩ	0...65535 (0...6553.5 mΩ)
	2	USINT	Link path length	6	
	3	EPATH	Link path	20 0F 24 47 30 01	
	4	WORD	Descriptor	0x0014 (scaling supported)	
	5	USINT	Data type	0xC7	
	6	USINT	Data length	2	
	13	USINT	Factor	1	
	14	USINT	Divisor	10	
	15	USINT	Basis	1	
	16	USINT	Offset	0	

Instance	Attribute ID	Data type ¹	Name	Default value	Value range
72	1	UINT	Initial calibration resistance, channel 1 (in 0.1 mΩ)	0 mΩ	0...65535 (0...6553.5 mΩ)
	2	USINT	Link path length	6	
	3	EPATH	Link path	20 0F 24 48 30 01	
	4	WORD	Descriptor	0x0014 (scaling supported)	
	5	USINT	Data type	0xC7	
	6	USINT	Data length	2	
	13	USINT	Factor	1	
	14	USINT	Divisor	10	
	15	USINT	Basis	1	
	16	USINT	Offset	0	
73	1	UINT	Initial calibration resistance, channel 2 (in 0.1 mΩ)	0 mΩ	0...65535 (0...6553.5 mΩ)
	2	USINT	Link path length	6	
	3	EPATH	Link path	20 0F 24 49 30 01	
	4	WORD	Descriptor	0x0014 (scaling supported)	
	5	USINT	Data type	0xC7	
	6	USINT	Data length	2	
	13	USINT	Factor	1	
	14	USINT	Divisor	10	
	15	USINT	Basis	1	
	16	USINT	Offset	0	
74	1	UINT	Initial calibration resistance, channel 3 (in 0.1 mΩ)	0 mΩ	0...65535 (0...6553.5 mΩ)
	2	USINT	Link path length	6	
	3	EPATH	Link path	20 0F 24 4A 30 01	
	4	WORD	Descriptor	0x0014 (scaling supported)	
	5	USINT	Data type	0xC7	
	6	USINT	Data length	2	
	13	USINT	Factor	1	
	14	USINT	Divisor	10	
	15	USINT	Basis	1	
	16	USINT	Offset	0	

Instance	Attribute ID	Data type ¹	Name	Default value	Value range
75	1	UINT	Initial calibration resistance, channel 4 (in 0.1 mΩ)	0 mΩ	0...65535 (0...6553.5 mΩ)
	2	USINT	Link path length	6	
	3	EPATH	Link path	20 0F 24 4B 30 01	
	4	WORD	Descriptor	0x0014 (scaling supported)	
	5	USINT	Data type	0xC7	
	6	USINT	Data length	2	
	13	USINT	Factor	1	
	14	USINT	Divisor	10	
	15	USINT	Basis	1	
	16	USINT	Offset	0	
76	1	UINT	Initial calibration resistance, channel 5 (in 0.1 mΩ)	0 mΩ	0...65535 (0...6553.5 mΩ)
	2	USINT	Link path length	6	
	3	EPATH	Link path	20 0F 24 4C 30 01	
	4	WORD	Descriptor	0x0014 (scaling supported)	
	5	USINT	Data type	0xC7	
	6	USINT	Data length	2	
	13	USINT	Factor	1	
	14	USINT	Divisor	10	
	15	USINT	Basis	1	
	16	USINT	Offset	0	
77	1	UINT	Initial calibration resistance, channel 6 (in 0.1 mΩ)	0 mΩ	0...65535 (0...6553.5 mΩ)
	2	USINT	Link path length	6	
	3	EPATH	Link path	20 0F 24 4D 30 01	
	4	WORD	Descriptor	0x0014 (scaling supported)	
	5	USINT	Data type	0xC7	
	6	USINT	Data length	2	
	13	USINT	Factor	1	
	14	USINT	Divisor	10	
	15	USINT	Basis	1	
	16	USINT	Offset	0	

Instance	Attribute ID	Data type ¹	Name	Default value	Value range
78	1	UINT	Initial calibration resistance, channel 7 (in 0.1 mΩ)	0 mΩ	0...65535 (0...6553.5 mΩ)
	2	USINT	Link path length	6	
	3	EPATH	Link path	20 0F 24 4E 30 01	
	4	WORD	Descriptor	0x0014 (scaling supported)	
	5	USINT	Data type	0xC7	
	6	USINT	Data length	2	
	13	USINT	Factor	1	
	14	USINT	Divisor	10	
	15	USINT	Basis	1	
	16	USINT	Offset	0	

- 1. USINT: Unsigned short integer (8-bit value, unsigned)
- SINT: Short integer (8-bit value, signed)
- UINT: Unsigned integer (16-bit value, unsigned)
- UDINT: Unsigned double integer (32-bit value, unsigned)
- BOOL: 1-bit value
- WORD: 16-bit value
- EPATH: CIP path segment

Changes to one or more instances are normally only temporary, i.e. they are undone again when the supply voltage is interrupted. All write protected instances with the descriptors 0x0010 are an exception (these cannot be changed); the same applies to the instances for the time (39), date (40), the clearable counters (43...51) and the passes through current transformer (62). Changes to these instances take effect immediately and are also effective the next time the device is switched on.



However, changes to other instances can be saved in a retentive memory area of the controller using the CIP "Save (0x16)" service, in which case the values are restored after the supply voltage is reconnected. The CIP "Restore (0x15)" service allows you to load stored values back from the retentive memory area to the temporary memory again at any time in order to undo unwanted changes.

The CIP "Reset (0x05)" service resets all instances of the parameter object to their default values. This applies to both temporary (volatile) and retentive objects.

The "Save", "Restore", and "Reset" services can only be applied to the class (instance 0). All instances of the parameter object concerned are simultaneously saved or restored.

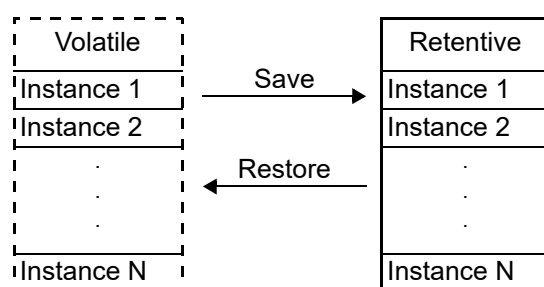
Parameter object



-  **When the controller is switched on, the last values saved in the retentive parameter object are automatically restored.**
-  **If the controller needs to be replaced, you must load the old parameter data into the new controller using a suitable network configuration tool and then run the "Save" service.**
-  **The parameter object is also reset to the default values if a type 1 reset is triggered on the identity object (class 1).**

8.7.1 Temperature range and alloy

This parameter determines both the temperature range and the heating element alloy. You can overwrite the setting of the rotary coding switch (↪ section 7.2.2 "Configuration of the rotary coding switch for the temperature range and alloy" on page 17) by changing the default value (10).

Value	Temperature range	Alloy
0	300 °C	TCR = 1700 ppm/K, adapted to the CIRUS heating elements
4	500 °C	TCR = 1700 ppm/K, adapted to the CIRUS heating elements
9	PC setting (visualization software)	PC setting (visualization software)
10	Rotary coding switch setting	Rotary coding switch setting
11	Variable: Parameter instance 11 is used	Variable: Parameter instance 10 as well as the channel-specific temperature coefficients at instances 20, 23, 36, 29, 32, 35 and 38 are used

You must always execute the AUTOCAL function after changing the "Temperature range / alloy", "Temperature range", or "Temperature coefficient" parameter.

8.7.2 Low temperature OK threshold

Low threshold value for the "OK" window.

Refer to section 8.6.6 "Temperature OK (TO)" on page 26 and section 8.7.10 "Temperature diagnosis" on page 50.

8.7.3 High temperature OK threshold

High threshold value for the "OK" window.

Refer to section 8.6.6 "Temperature OK (TO)" on page 26 and section 8.7.10 "Temperature diagnosis" on page 50.

8.7.4 Variable calibration temperature

The calibration temperature is set to 20 °C by default. You can change it to another value between 0 °C and 40 °C in order to adapt it to the temperature of the cold heating element.

Some EtherNet/IP™ scanners do not allow the parameter data to be changed during operation. In this case, the calibration temperature cannot be adapted to the actual ambient conditions in the machines.

The calibration temperature can thus be enabled for setting by means of the input data by specifying the value "-1" in the parameter data. The calibration temperature can then be specified via the "Set point / AC temperature" input data (↪ section 8.5.1 "Automatic zero calibration AUTOCAL (AC)" on page 23).

After a change of the calibration temperature, the AUTOCAL function must be performed.

8.7.5 Heating time limit

The heating time limit provides additional protection against unwanted continuous heating. The controller automatically deactivates the heating impulse after the set heating time limit has elapsed if the start bit remains set for longer than the time specified with this limit. The ST bit must be reset before the controller can be started up again. The heating time limit is activated by default (5.00 s) but can be set to any value between 0 s and 9.99 s (0 and 999).

8.7.6 Measuring impulse duration

The length of the measuring impulses generated by the controller can be set with the parameter at index 10. It may be necessary to set a measuring impulse longer than the default 1.7 ms for certain applications.

8.7.7 Data format

This parameter specifies the order of the bytes ("Little Endian (Intel)" or "Big Endian (Motorola)") in the cyclic data; this setting applies to both input and output data (↪ section 8.4 "Communication protocol" on page 22).



We recommend selecting "Big Endian (Motorola)" for Siemens PLCs.

8.7.8 Correction factor Co

The correction factor Co allows you to adapt the controller to the actual conditions in the machine (type of UPT heating element, impulse transformer specification, length of connecting cables, cooling etc.). You can set the required correction factor with this parameter.

Proceed as follows to determine the optimum correction factor Co:

1. Controller settings:

- Set temperature: 160...180 °C
- Sealing time: 0.20...0.30 s

2. Heating impulses (ST bit = 1):

Proceed as described in section 8.5.2 "Start (ST)" on page 24.

Slowly increase the correction factor, starting either with the lowest value (50%) or with the value recommended in the ROPEX Application Report minus 25%, until the actual temperature at the end of the heating impulse corresponds to the set temperature.

The correction factor should be checked, and if necessary corrected, whenever the machine is operated or the set temperature or the sealing time is changed.

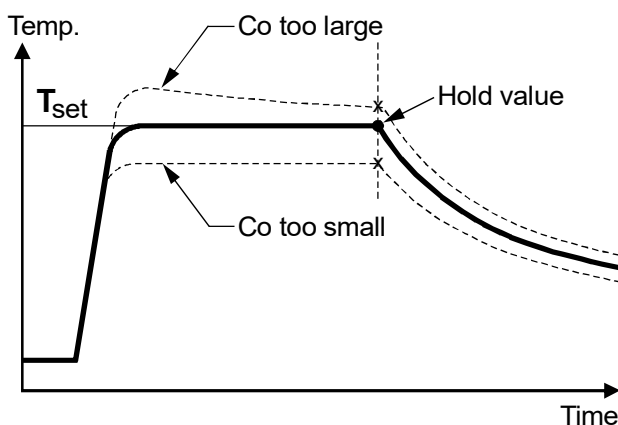

8.7.9 Maximum start temperature

You can set the required maximum start temperature in the parameter data. This temperature is the maximum allowable actual value at the start time. The value is determined by the controller at the start of each impulse and compared with the set value.

This function serves to monitor the cooling circuit.

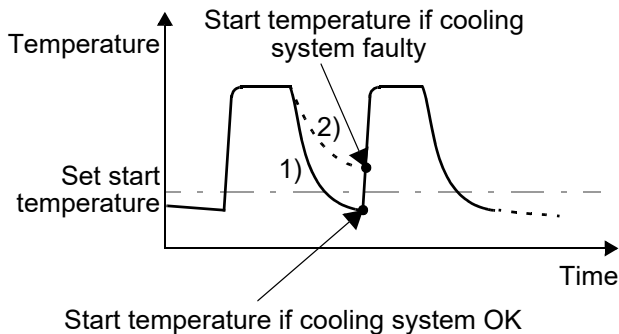

If the cooling system is intact, curve 1) applies. If the cooling system is faulty, curve 2) applies instead because the water is no longer cooled. The temperature never falls below the value set with this menu step. In this case, the controller ignores the next heatup command. Error code 305 appears and the alarm relay is switched (↪ section 8.19 "Error messages" on page 61). The idea is to prevent the UPT sealing bar from being destroyed. The maximum value of the setting range is limited by the specified maximum value and the set temperature range. Both values are selected in the parameter data.

Setting:

It is advisable not to set this parameter until you have determined the optimum heatsealing parameters (temperature and cooling time) for production. The start temperature should be set to approximately 50% of the heatsealing temperature for the trial run, to enable the optimum working parameters to be established correctly.

8.7.10 Temperature diagnosis

An additional temperature diagnosis can be activated in the parameter data (EDS file). The UPT-6011 checks whether the actual temperature is within a settable tolerance band ("OK" window) either side of the set temperature. The high ($\Delta\vartheta_{high}$) and low ($\Delta\vartheta_{low}$) tolerance limits are the same as for the "Temperature OK" function (TO bit ↪ section 8.6.6 "Temperature OK (TO)" on page 26). The limits are set to -10 K and +10 K by default. If the ACTUAL temperature is inside the specified tolerance band when the START signal is activated, the temperature diagnosis is activated as well. If the ACTUAL temperature leaves the tolerance band, the corresponding error code (307, 308) appears and the alarm relay is switched (↪ section 8.19 "Error messages" on page 61).

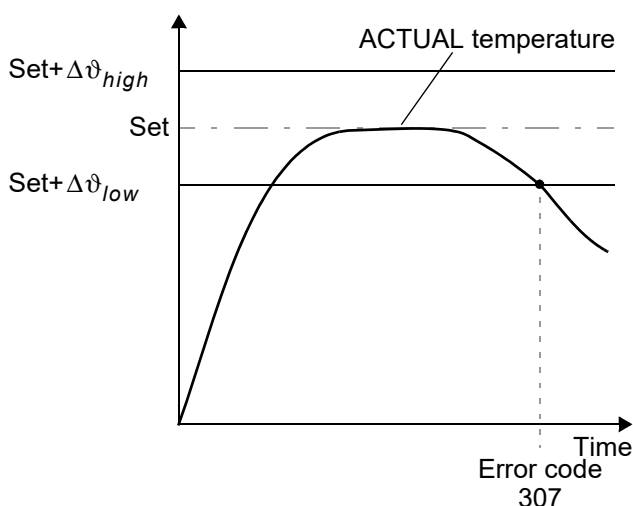

If the temperature diagnosis is not activated by the time the START signal is deactivated (i.e. if the ACTUAL temperature does not exceed the high or low tolerance limit), the corresponding error code (309, 310) appears and the alarm relay is switched.

An additional delay time (0..9.99 s) can be set in the parameter data (EDS file). The first time the low tolerance limit is exceeded, the temperature diagnosis is not activated until the configured delay time has elapsed. The temperature diagnosis function can thus be selectively deactivated, e.g. if the temperature drops temporarily owing to the closure of the sealing jaws.

The high and low tolerance limits cannot be set in the ROPEX visualization software. The same limits apply as with the TO bit. They can only be set in the parameter data (↪ section 8.7 "Parameter object (class: 0x0F)" on page 28).

8.7.11 Heatup timeout

An additional heatup timeout can be activated in the parameter data (EDS file).

This timeout starts when the ST bit is set. The UPT-6011 then monitors the time required for the ACTUAL temperature to reach 95% of the SET temperature. If this time is longer than the configured time, the corresponding error code (304) appears and the alarm relay is switched (↪ section 8.19 "Error messages" on page 61).

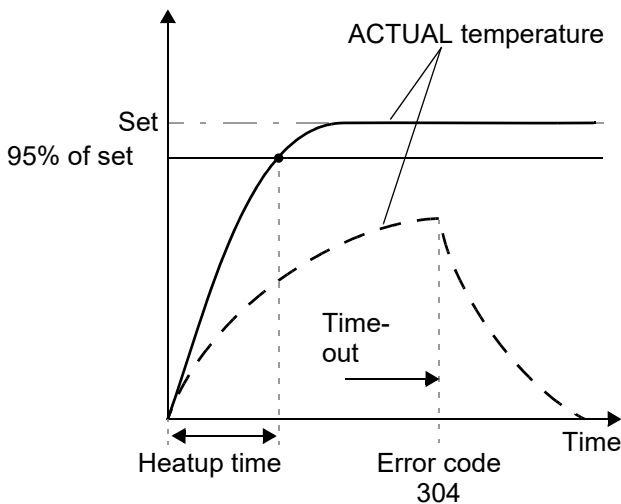

The "Heatup timeout" function must be enabled for use in the parameter data (↪ section 8.7 "Parameter object (class: 0x0F)" on page 28) (default setting: heatup timeout off).

8.7.12 Hold mode

The ACTUAL temperature output via the EtherNet/IP™ protocol can be configured in the parameter data (EDS file) as follows:

1. **"Off" (factory setting)**
The ACTUAL temperature is always output in real time.
2. **"On"**
The ACTUAL temperature that was valid at the end of the last heatsealing phase is output. When the controller is switched on, the real ACTUAL temperature is indicated up until the end of the first heating phase.
3. **"2 sec."**
This setting causes the current ACTUAL temperature to be output for an additional 2 seconds by means of the EtherNet/IP™ protocol at the end of a heatsealing phase. The ACTUAL temperature is then output again in real time until the end of the next heatsealing phase.

Hold mode only applies to the ACTUAL temperature which is output via the EtherNet/IP™ protocol and the digital temperature display in the ROPEX visualization software. It has no effect on the ACTUAL temperature that appears at the controller's analog output or is plotted in the graphics window of the ROPEX visualization software.

The various hold modes are shown below:

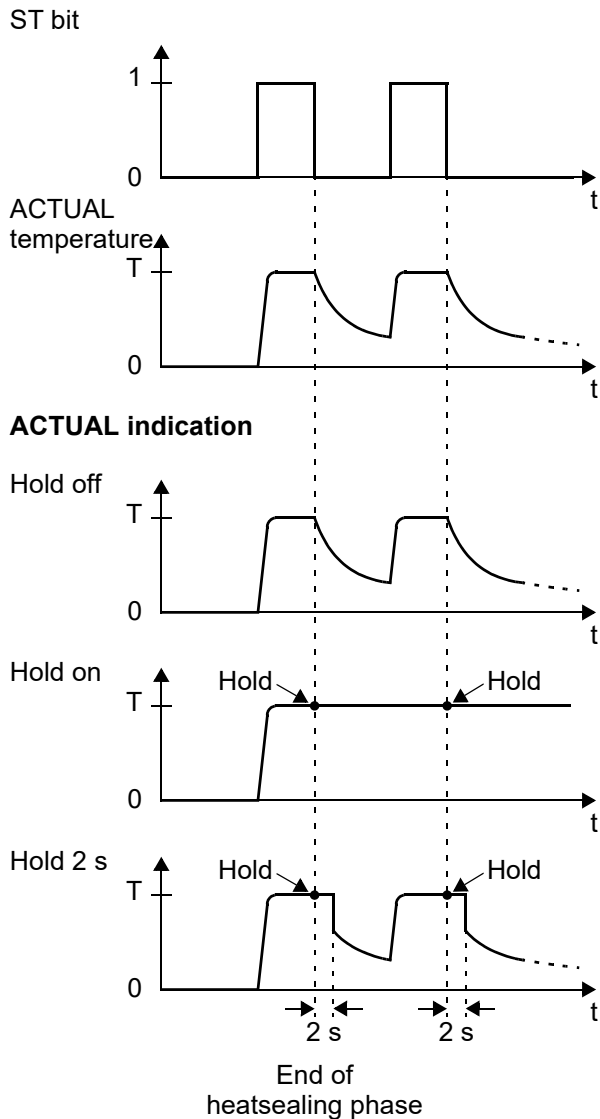

The "Hold mode" function must be activated in the parameter data (↪ section 8.7 "Parameter object (class: 0x0F)" on page 28) (default setting: hold mode off).

8.8 Integrated web server

The integrated web server enables quick and easy access to status information and parameter values of the temperature controller via the existing Ethernet connection. The device protocol can additionally be read out and displayed. A graph showing the last 5 seconds of a heating impulse allows a rapid qualitative evaluation of the controlled system.

The latest version of the operating instructions can be downloaded from the ROPEX website by clicking on the picture of the device on any page. To make sure this latest version is always available in any selectable language, the instructions are not stored in the device; you must therefore have an Internet connection in order to access the operating instructions.

You can go direct to the official ROPEX website by clicking on the ROPEX logo in the top right-hand corner.

The web server uses JavaScript and has been successfully tested with Internet Explorer 9, 10, and 11 as well as with Microsoft Edge. It also works with the latest version of the Safari and Firefox browsers.

8.8.1 Home page

This page contains general product information under "Device Information", for instance the product name, serial number, firmware version, MAC address, and real-time Ethernet protocol. You can also download the correct device description file for your product here (↪ section 8.3 "Device description file (EDS)" on page 22). No Internet connection is necessary to do this because the file is already stored in the device's internal memory.

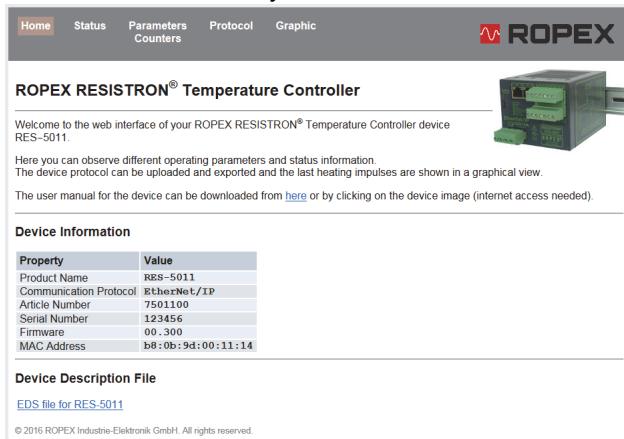

The screenshot shows the 'Home' page of the ROPEX RESISTRON Temperature Controller web interface. The navigation menu includes Home, Status, Parameters Counters, Protocol, and Graphic. The main heading is 'ROPEX RESISTRON® Temperature Controller'. Below this, there is a welcome message and instructions on how to view operating parameters and status information. A 'Device Information' table is displayed, followed by a link to the 'Device Description File' (EDS file for RES-5011).

Property	Value
Product Name	RES-5011
Communication Protocol	EtherNet/IP
Article Number	7501100
Serial Number	123456
Firmware	00.300
MAC Address	b8:0b:9d:00:11:14

8.8.2 Status page

This page provides an overview of the current controller status.

"Online" indicates whether a connection has been set up to the PLC.

The inputs (↪ section 8.5 "Input data" on page 23) are shown in the left-hand column, the outputs (↪ section 8.6 "Output data" on page 25) in the middle column, and the current status of all device LEDs (↪ section 8.1 "LEDs and controls" on page 20) in the right-hand column.

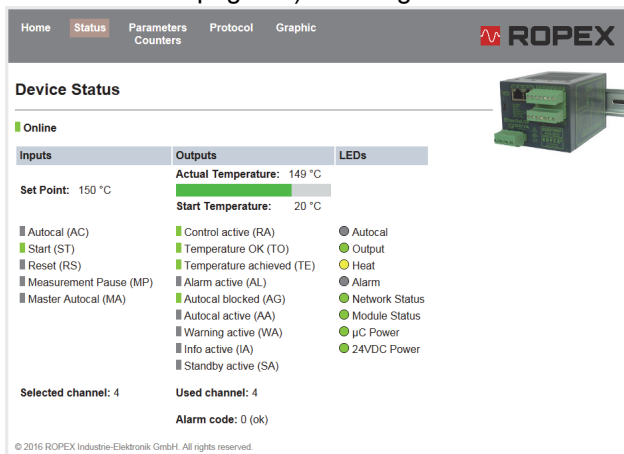

The screenshot shows the 'Status' page of the ROPEX RESISTRON Temperature Controller web interface. The navigation menu includes Home, Status, Parameters Counters, Protocol, and Graphic. The main heading is 'Device Status'. The status is 'Online'. The page is divided into three columns: Inputs, Outputs, and LEDs. The Inputs column shows 'Set Point: 150 °C'. The Outputs column shows 'Actual Temperature: 149 °C' and 'Start Temperature: 20 °C'. The LEDs column shows a list of status indicators with corresponding icons.

Inputs	Outputs	LEDs
Set Point: 150 °C	Actual Temperature: 149 °C Start Temperature: 20 °C	Autocal (AC) Start (ST) Reset (RS) Measurement Pause (MP) Master Autocal (MA)
Autocal (AC) Start (ST) Reset (RS) Measurement Pause (MP) Master Autocal (MA)	Control active (RA) Temperature OK (TO) Temperature achieved (TE) Alarm active (AL) Autocal blocked (AG) Autocal active (AA) Warning active (WA) Info active (IA) Standby active (SA)	Autocal Output Heat Alarm Network Status Module Status µC Power 24VDC Power
Selected channel: 4	Used channel: 4 Alarm code: 0 (ok)	

8.8.3 Parameters / Counters page

This page shows all parameter values received by the temperature controller from the EtherNet/IP™ scanner. If the parameters have been changed using acyclic services, these changes are also indicated here.

For the meanings of the parameter data, refer to section 8.7 "Parameter object (class: 0x0F)" on page 28.

Under "Counters" you see a list of all cycle and operating hours counters, which are useful for statistical purposes.

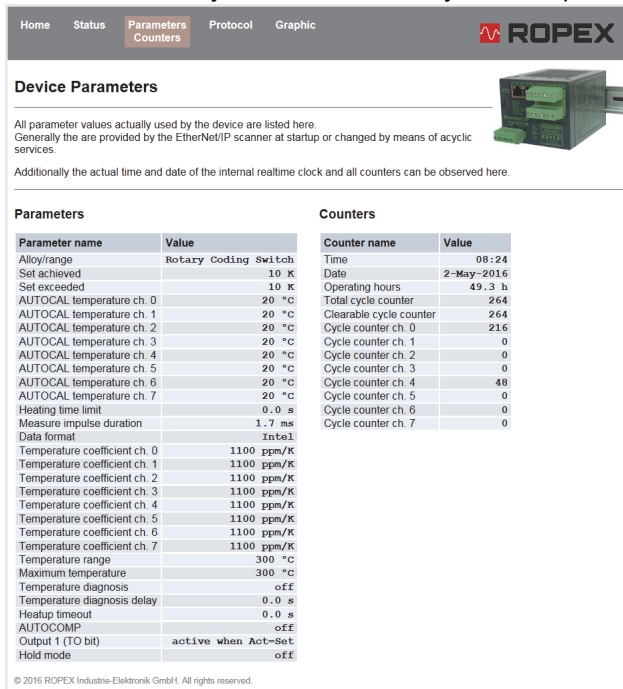

The screenshot shows the 'Parameters' and 'Counters' sections of the ROPEX web interface. The 'Parameters' table lists various settings like temperature coefficients and limits. The 'Counters' table lists operating hours and cycle counters for different channels.

Parameter name	Value	Counter name	Value
Alloy/range	Rotary Coding Switch	Time	08:24
Set achieved	10 K	Date	2-May-2016
Set exceeded	10 K	Operating hours	49.3 h
AUTOCAL temperature ch. 0	20 °C	Total cycle counter	264
AUTOCAL temperature ch. 1	20 °C	Clearable cycle counter	264
AUTOCAL temperature ch. 2	20 °C	Cycle counter ch. 0	216
AUTOCAL temperature ch. 3	20 °C	Cycle counter ch. 1	0
AUTOCAL temperature ch. 4	20 °C	Cycle counter ch. 2	0
AUTOCAL temperature ch. 5	20 °C	Cycle counter ch. 3	0
AUTOCAL temperature ch. 6	20 °C	Cycle counter ch. 4	48
AUTOCAL temperature ch. 7	20 °C	Cycle counter ch. 5	0
Heating time limit	0.0 s	Cycle counter ch. 6	0
Measure impulse duration	1.7 ms	Cycle counter ch. 7	0
Data format	int32		
Temperature coefficient ch. 0	1100 ppm/K		
Temperature coefficient ch. 1	1100 ppm/K		
Temperature coefficient ch. 2	1100 ppm/K		
Temperature coefficient ch. 3	1100 ppm/K		
Temperature coefficient ch. 4	1100 ppm/K		
Temperature coefficient ch. 5	1100 ppm/K		
Temperature coefficient ch. 6	1100 ppm/K		
Temperature coefficient ch. 7	1100 ppm/K		
Temperature range	300 °C		
Maximum temperature	300 °C		
Temperature diagnosis	off		
Temperature diagnosis delay	0.0 s		
Heatup timeout	0.0 s		
AUTOCOMP	off		
Output 1 (TO bit)	active when Act=Set		
Hold mode	off		

8.8.4 Protocol page

You can download and display the device protocol for the temperature controller on this page. You see the overall size of the protocol ("Total event entries") as well as the upload progress. All entries appear in the form of a table. A timestamp (generated by the built-in clock), the operating hours and cycle counters, and the channel selected at the time are shown for each entry.

In addition to errors, the protocol also contains entries of general interest such as "Clock set" or the "AUTOCAL" function. An error code provides information on the cause of all events in the protocol. The error codes are described in detail in section 8.19 "Error messages" on page 61. Each error code is explained in a tooltip when you hover over it briefly.

The data can also be exported to a CSV file to enable further processing in another software program. By clicking on the appropriate button you can select a comma separated format or a semicolon separated format.

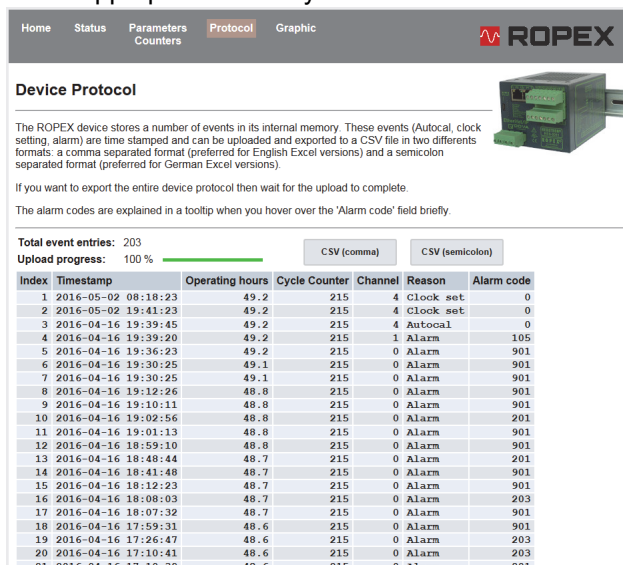

The screenshot shows the 'Device Protocol' section of the ROPEX web interface. It displays the total number of event entries (203) and the upload progress (100%). Below this, there are two buttons for exporting the data: 'CSV (comma)' and 'CSV (semicolon)'. A table of event entries is shown, with columns for Index, Timestamp, Operating hours, Cycle Counter, Channel, Reason, and Alarm code.

Index	Timestamp	Operating hours	Cycle Counter	Channel	Reason	Alarm code
0	2016-05-02 08:18:23	49.2	215	4	Clock set	0
2	2016-05-02 19:41:23	49.2	215	4	Clock set	0
3	2016-04-16 19:39:45	49.2	215	4	Autocal	0
4	2016-04-16 19:39:20	49.2	215	1	Alarm	105
5	2016-04-16 19:36:23	49.2	215	0	Alarm	901
6	2016-04-16 19:30:25	49.1	215	0	Alarm	901
7	2016-04-16 19:30:25	49.1	215	0	Alarm	901
8	2016-04-16 19:12:26	48.8	215	0	Alarm	901
9	2016-04-16 19:10:11	48.8	215	0	Alarm	901
10	2016-04-16 19:02:56	48.8	215	0	Alarm	201
11	2016-04-16 19:01:13	48.8	215	0	Alarm	901
12	2016-04-16 18:59:10	48.8	215	0	Alarm	901
13	2016-04-16 18:48:44	48.7	215	0	Alarm	201
14	2016-04-16 18:41:48	48.7	215	0	Alarm	901
15	2016-04-16 18:12:23	48.7	215	0	Alarm	901
16	2016-04-16 18:08:03	48.7	215	0	Alarm	203
17	2016-04-16 18:07:32	48.7	215	0	Alarm	901
18	2016-04-16 17:59:31	48.6	215	0	Alarm	901
19	2016-04-16 17:26:47	48.6	215	0	Alarm	203
20	2016-04-16 17:10:41	48.6	215	0	Alarm	203
21	2016-04-16 17:10:38	48.6	215	0	Alarm	201

The download may take a few seconds, depending on the number of entries which are stored here. The newest events appear at the top of the list.

If any new events occur while this page is displayed, you do not see them until you refresh the list by clicking on the "Protocol" menu again.

8.8.5 Graphic page

The temperature controller has an internal memory which can store temperature curves over a period of up to 5 seconds. This memory is automatically filled when the ST bit is set. You can display or export the memory contents on the Graphic page.

By clicking on "Refresh", you cause the graphic data to be downloaded from the memory of the temperature controller and displayed again.

"Clear" clears all data from the memory (disconnecting the 24 VDC supply voltage has the same effect).

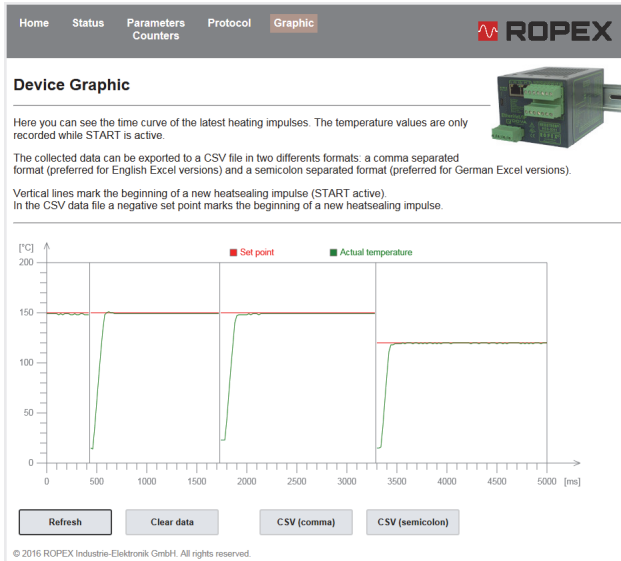

The vertical lines mark the beginning of a new heatsealing impulse (ST bit set). A negative set point indicates the start of a new impulse in the exported data. Cooling processes are not normally visible because they take place when the ST bit is reset.

8.8.6 Calibration page



This page is first available as from firmware version 303.

The temperature controller stores the absolute calibration resistance of each channel (Calibration resistance ch. 0...7) with an resolution of 0.1 mΩ.

The calculation of the respective calibration resistance is done at the end of the AUTOCAL function (↪ section 8.5.1 "Automatic zero calibration AUTOCAL (AC)" on page 23).

The initial calibration resistances (Initial calibration resistance ch. 0...7) are calculated if the Master-AUTOCAL function is executed (↪ section 8.5.5 "Master AUTOCAL (MA)" on page 24).

These initial calibration resistances are the basis for the calculation of the calibration deviation. Each execution of the AUTOCAL function will calculate both, the absolute calibration resistance and likewise the percentual calibration deviation towards the initial calibration resistance.

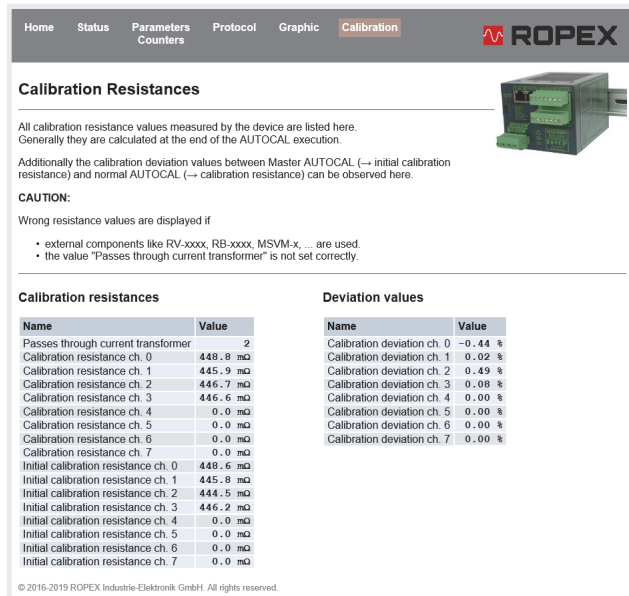

Home Status Parameters Counters Protocol Graphic **Calibration**

Calibration Resistances

All calibration resistance values measured by the device are listed here. Generally they are calculated at the end of the AUTOCAL execution.

Additionally the calibration deviation values between Master AUTOCAL (→ initial calibration resistance) and normal AUTOCAL (→ calibration resistance) can be observed here.

CAUTION:

Wrong resistance values are displayed if

- external components like RV-xxxx, RB-xxxx, MSVM-x, ... are used.
- the value "Passes through current transformer" is not set correctly.

Calibration resistances		Deviation values	
Name	Value	Name	Value
Passes through current transformer	2	Calibration deviation ch. 0	-0.44 %
Calibration resistance ch. 0	448.8 mΩ	Calibration deviation ch. 1	0.02 %
Calibration resistance ch. 1	445.9 mΩ	Calibration deviation ch. 2	0.49 %
Calibration resistance ch. 2	446.7 mΩ	Calibration deviation ch. 3	0.00 %
Calibration resistance ch. 3	446.6 mΩ	Calibration deviation ch. 4	0.00 %
Calibration resistance ch. 4	0.0 mΩ	Calibration deviation ch. 5	0.00 %
Calibration resistance ch. 5	0.0 mΩ	Calibration deviation ch. 6	0.00 %
Calibration resistance ch. 6	0.0 mΩ	Calibration deviation ch. 7	0.00 %
Calibration resistance ch. 7	0.0 mΩ		
Initial calibration resistance ch. 0	448.6 mΩ		
Initial calibration resistance ch. 1	445.8 mΩ		
Initial calibration resistance ch. 2	444.5 mΩ		
Initial calibration resistance ch. 3	446.2 mΩ		
Initial calibration resistance ch. 4	0.0 mΩ		
Initial calibration resistance ch. 5	0.0 mΩ		
Initial calibration resistance ch. 6	0.0 mΩ		
Initial calibration resistance ch. 7	0.0 mΩ		

© 2016-2019 ROPEX Industrie-Elektronik GmbH. All rights reserved.

These values are displayed on the Calibration page.

Additionally the actual value of „passes through current transformer“ are displayed. This value can be read or written by means of acyclic services. Set this value to the real wire passes through the current transformer for that the absolute resistance values can be calculated correctly. This value has no influence on the calculation of the percentual calibration deviation.

! The calculation of the absolute resistance values is liable to variation and imprecision due to tolerances in production, to application dimensioning, to quality of cabling, to fluctuations in the power supply, etc.

8.9 Undervoltage detection

Trouble-free operation of the temperature controller is guaranteed within the line voltage and 24 VDC supply voltage tolerances specified in section 10 "Technical data" on page 67.

If the 24 VDC supply voltage drops below the permitted lower limit, the controller is switched to standby mode. No more heatsealing processes take place and no more measuring impulses are generated. Normal operation is resumed when the input voltage returns to the specified tolerance range again.

Standby mode is indicated by 0...3 °C (i.e. approx. 0 V) at the analogue output. In addition, the SA bit is set in the status word for the cyclic output data.

! Trouble-free operation of the controller is only guaranteed within the specified tolerance range of the input voltage. An external voltage monitor must be connected to prevent low line or 24 VDC supply voltage from resulting in defective heatseals.

8.10 Temperature meter (actual value output)

The UPT-6011 supplies an analog 0...10 VDC signal, which is proportional to the real ACTUAL temperature, at terminals 17+18.

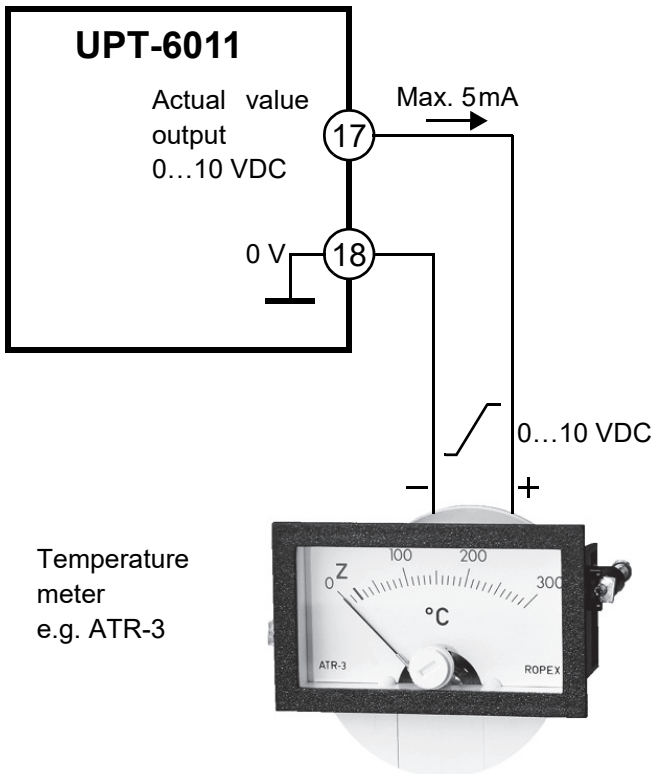

Voltage values:

0 VDC → 0 °C

10 VDC → 300 °C or 500 °C, depending on the device configuration

The relationship between the change in the output voltage and the ACTUAL temperature is linear.

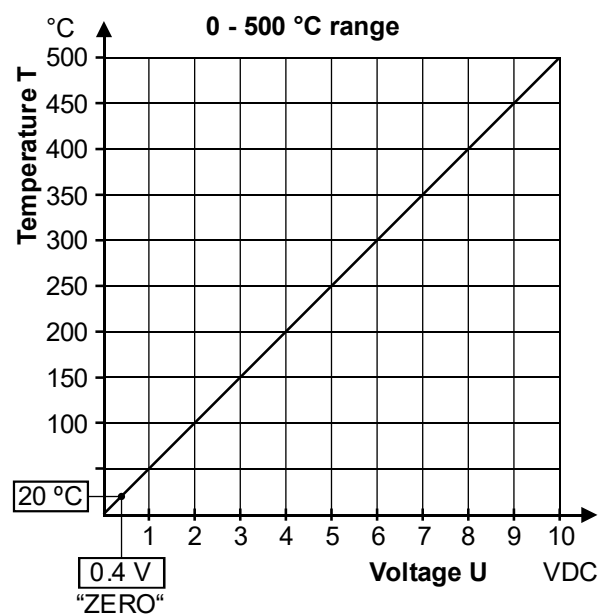
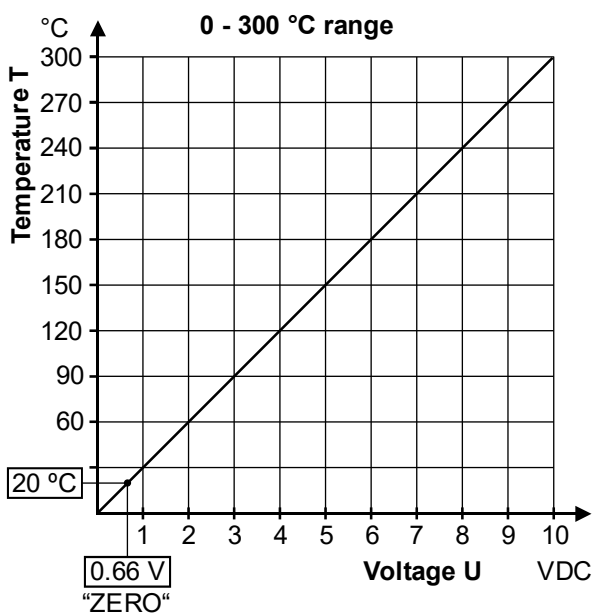

An indicating instrument can be connected to this output in order to visualize the temperature of the heating element.

The ROPEX ATR-x temperature meter is optimally adapted to this application in every respect (size, scale, dynamic behaviour) and can be used for this, if needed (↪ section 13 "How to order" on page 70).

The meter not only facilitates SET-ACTUAL comparisons but also enables other criteria such as the heating rate, set point achieved within the specified time, cooling of the heating element etc. to be evaluated.

The temperature meter additionally permits disturbances in the control loop (loose connections, contacting or wiring problems) as well as any line disturbances to be observed extremely efficiently and interpreted accordingly. The same applies if several neighbouring control loops interfere with one another.

If a fault is signalled, this analog output is used to display a selective error message (↪ section 8.19 "Error messages" on page 61).

8.11 Booster connection

The UPT-6011 controller has a connection for an external switching amplifier (booster) as standard. This connection (at terminals 15+16) is necessary for high primary currents (continuous current > 5 A, pulsed current > 25 A). The booster should be connected as described in section 6.7 "Wiring diagram with booster connection" on page 15.



The connecting cable to the booster must not be longer than 1 m; it must also be twisted in order to reduce EMC interference to a minimum.

8.12 USB interface for visualization software ROPEXvisual®

A USB interface (type: Micro USB) is provided for system diagnostics and process visualization. This USB interface enables a data connection to be set up to ROPEXvisual®, the ROPEX visualization software.

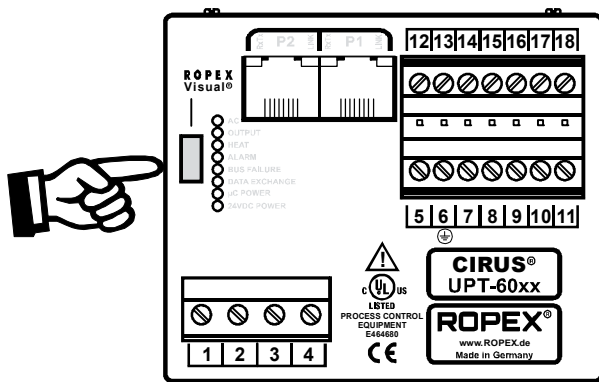

The ROPEX visualization software is described in a separate document. The software and the documentation are available in the [download area](#) (search term: "Visual").

8.13 AUX interface

Internal interface for diagnostics and maintenance. This interface is not currently available.

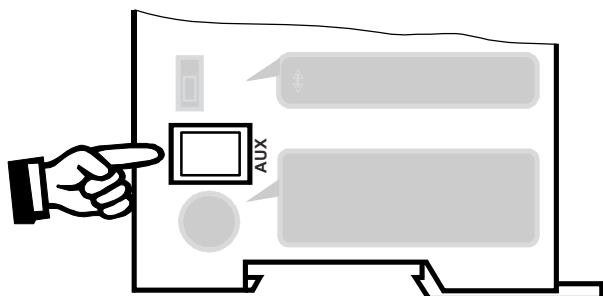

8.14 Total cycle counter

The number of heatsealing cycles executed since the controller was shipped is stored in the internal memory (ST bit = 1). This is a read-only counter which cannot be reset. It can be displayed in the ROPEX visualization software (↪ section 8.12 "USB interface for visualization software ROPEXvisual[®]" on page 58), via the integrated web server, or using the acyclic services of the EtherNet/IP[™] interface.

8.15 Operating hours counter

The number of operating hours since the controller was shipped is stored in the internal memory. This counter works with a resolution of six minutes. It is a read-only counter which cannot be reset. It can be displayed in the ROPEX visualization software (↪ section 8.12 "USB interface for visualization software ROPEXvisual[®]" on page 58), via the integrated web server, or using the acyclic services of the EtherNet/IP[™] interface.

8.16 Data memory for error messages and AUTOCAL

To simplify error diagnoses during operation, the UPT-6011 controller has a data memory for error messages (↪ section 8.19 "Error messages" on page 61) and executed AUTOCAL functions (↪ section 8.5.1 "Automatic zero calibration AUTOCAL (AC)" on page 23).

The 400 most recent messages are stored. They can be read out and displayed in the ROPEX visualization software (↪ section 8.12 "USB interface for visualization software ROPEXvisual[®]" on page 58) or via the integrated web server.

The UPT-6011 also features a built-in clock (↪ section 8.17 "Built-in clock (date and time)" on page 59). All messages are saved in the data memory together with their date and time of occurrence (timestamp).

 **The stored messages can be exported as a csv-file. If needed, ROPEX can evaluate the exported file and create an error diagnosis.**

8.17 Built-in clock (date and time)

The UPT-6011 has a built-in clock. All messages are saved in the data memory (↪ section 8.16 "Data memory for error messages and AUTOCAL" on page 59) together with their date and time of occurrence (timestamp). Error messages can thus be interpreted more accurately whenever a problem needs to be analyzed.

The built-in clock can be set and read out in the ROPEX visualization software (↪ section 8.12 "USB interface for visualization software ROPEXvisual[®]" on page 58) or using the acyclic services of the EtherNet/IP[™] interface. The date and time can be read out but not set via the integrated server.

A maintenance-free capacitor is used to operate the clock. There is no battery that has to be replaced every now and then.

The controller must remain switched on for at least three hours to make sure the clock's capacitor is fully charged. When the controller is switched off, the fully charged capacitor can keep the clock running for approximately 2...4 weeks. If the controller is switched off for longer, the date and time will have to be set again. You can do this in the ROPEX visualization software (↪ section 8.12 "USB interface for visualization software ROPEXvisual[®]" on page 58) or using the acyclic services of the EtherNet/IP[™] interface.

The capacitor is not charged when it leaves the factory. When the controller is started up, you must set the clock if you want error messages to be saved in the data memory (↪ section 8.16 "Data memory for error messages and AUTOCAL" on page 59) together with their date and time of occurrence.

The controller can also be operated without the clock. In this case, the dates and times that are saved in the data memory will be invalid (↪ section 8.16 "Data memory for error messages and AUTOCAL" on page 59). However, this has no effect on the temperature control functions.

8.18 System monitoring / alarm output

To increase operational safety and avoid faulty heatsealing, this controller incorporates special hardware and software features to facilitate selective error detection and diagnosis. Both the external wiring and the internal system are monitored.

These features significantly assist the operator in identifying the cause of abnormal situations.

A system fault is reported or differentiated by means of the following indications.

A.) Red "ALARM" LED on the controller with three states:

1. Blinking fast (4 Hz):

The "AUTOCAL" function should be executed (error codes 104...106, 211, 302, 303).

2. Blinking slowly (1 Hz):

The system configuration is incorrect and the zero calibration ("AUTOCAL" function) was unsuccessful (↪ section 7.2 "Device configuration" on page 16). This corresponds to error codes 111...114).

3. Lit continuously:

A fault is preventing the system from starting (error codes 101...103, 107, 108, 201...203, 304, 305, 307, 308, 9xx).

As a rule, this refers to an external wiring fault.

B.) Alarm relay (relay contact terminals 12+13+14):

This relay is set at the factory as follows:

- **DE-ENERGIZED** in operating states A.1 and A.2 but energized if a START signal is present in one of these states.
- **ENERGIZED** in operating state A.3.

If the alarm relay has the opposite configuration to the factory setting (↪ section 7.2.4 "Configuration of the alarm relay" on page 18), these states are reversed.

C.) Error code indicated via the EtherNet/IP[™] protocol:

If an error occurs, the AL bit is set and possibly also the WA bit. The error code is contained in the third word at bit positions 0...9 (↪ section 8.6.12 "All 16 bits of the first word must be interpreted as a signed number (twos complement notation). The resolution is 1 °C. During the calibration procedure or if a fault occurs, the actual value is 0. Error codes" on page 27).

D.) Error code indicated via the actual value output 0...10 VDC (terminals 17+18):

Since a temperature indication is no longer necessary if a fault occurs, the actual value output is used to display error messages whenever a fault is signalled.

Thirteen voltage levels are available for this purpose in the 0...10 VDC range, each of which is assigned an error code (↪ section 8.19 "Error messages" on page 61).

If a state that requires AUTOCAL occurs – or if the device configuration is incorrect – (error codes 104...106, 111...114, 211, 302, 303), the signal at the actual value output jumps back and forth at 1 Hz between the voltage value corresponding to the error and the end of the scale (10 VDC, i.e. 300 °C or 500 °C). If the START signal is present in one of these states, the voltage value does not change any more.

If a ROPEX temperature meter (e.g. an ATR-x) is connected to the controller's analog output, the temperature indication can be directly assigned to the error codes if an alarm is signalled.

An error message can be reset by setting the RS bit or by momentarily interrupting the power to the controller (24 VDC supply voltage).

If an error message is reset with the RS bit, it is not actually reset until the RS bit is reset.

Invalid error messages may appear when the controller is switched off owing to the undefined operating state. This must be taken into account when they are evaluated by the higher-level controller (e.g. a PLC) in order to avoid false alarms.

8.19 Error messages

The table below shows the meaning of the error codes. It includes a description of each error as well as the required corrective action.

The block diagram in section 8.20 "Fault areas and causes" on page 65 helps you clear a particular error quickly and efficiently.

Thirteen voltage levels for diagnosing errors appear at the CIRUS® temperature controller's actual value output. The error messages are even more finely differentiated internally. The 3-digit error codes described below can be displayed via the EtherNet/IP™ interface or in the ROPEX visualization software (↪ section 8.12 "USB interface for visualization software ROPEXvisual®" on page 58) to facilitate troubleshooting).

 **If the actual value output is evaluated in order to identify an error message – in the higher-level controller, for instance – the tolerance window must be adjusted to prevent incorrect interpretations. Please note the tolerances of the actual value output (↪ section 10 "Technical data" on page 67).**

Part 1 of 3: Error messages (faults)

NOTE: The error messages shown here are output as faults (constant error voltage at actual value output, alarm LED lit continuously, alarm relay energized).

Error code	Act. val. output voltage [V]	Cause	Action if machine started for first time	Action if machine already operated, heating element not changed
101	0.66	No current signal	Fault area ①	Fault area ①
102	1.33	No voltage signal	Fault area ③	Fault area ③
103	2.00	No current / voltage signals	Fault area ②	Fault areas ② ⑨
107	2.66	Temperature step, down	Fault areas ④ ⑤ ⑥ ("loose contact")	Fault areas ④ ⑤ ⑥ ("loose contact")
108		Temperature step, up		
307		Temperature too high / low (↪ section 8.7.10)		
308				
309				
310				
201	3.33	No line frequency / line frequency fluctuates	Check power supply	Check power supply
202		Line frequency too high / fluctuates		
203		Line frequency too low / fluctuates		
304	4.00	Heatup time too long (↪ section 8.7.11)	Perform RESET	Perform RESET
305		Start temperature too high (↪ section 8.7.9)		
901	4.66	No line voltage / sync signal	↪ Section 8.2	↪ Section 8.2
913		Triac defective	Replace device	Replace device
914		Internal fault, device defective	Replace device	Replace device
915				
916				
917		Jumper for alarm output incorrect	Check jumper	Check jumper
918				

Part 2 of 3: Error messages (warnings)

NOTE: The specified error messages are initially output as warnings (actual value output jumps back and forth between two values, alarm LED blinks, alarm relay de-energized). When the START signal is activated, the warning changes to a fault (actual value output no longer jumps back and forth, see ***bold italic values***, alarm LED lit continuously, alarm relay energized).

Error code	Act. val. output voltage [V]	Cause	Action if machine started for first time	Action if machine already operated, heating element not changed
104	↔ 5.33 ↔ ↔ 10 ↔	Current signal incorrect, incorrect impulse transformer specification	Perform AUTOCAL , check transformer specification, fault areas ⑦ ⑧	Fault areas ④ ⑤ ⑥ ("loose contact")
105		Voltage signal incorrect, incorrect impulse transformer specification		
106		Current and voltage signals incorrect, incorrect impulse transformer specification		
302		Temperature too low, calibration not performed, loose contact, ambient temp. fluctuates	Perform AUTOCAL and / or	
303		Temperature too high, calibration not performed, loose contact, ambient temp. fluctuates	fault areas ④ ⑤ ⑥ ("loose contact")	
211		↔ 6.00 ↔ ↔ 10 ↔	Data error	

Part 3 of 3: Error messages (warnings)

NOTE: The specified error messages are initially output as warnings (actual value output jumps back and forth between two values, alarm LED blinks, alarm relay de-energized). When the START signal is activated, the warning changes to a fault (actual value output no longer jumps back and forth, see **bold italic values**, alarm LED lit continuously, alarm relay energized).

Error code	Act. val. output voltage [V]	Cause	Action if machine started for first time	Action if machine already operated, heating element not changed
111	<i>↔ 6.66 ↔</i> <i>↔ 10 ↔</i>	Current signal incorrect, no calibration possible	Fault area ⑧, check configuration	Fault areas ④ ⑤ ⑥ ("loose contact")
112	<i>↔ 7.33 ↔</i> <i>↔ 10 ↔</i>	Voltage signal incorrect, no calibration possible	Fault area ⑦, check configuration	Fault areas ④ ⑤ ⑥ ("loose contact")
113	<i>↔ 8.00 ↔</i> <i>↔ 10 ↔</i>	Current / voltage signals incorrect, no calibration possible	Fault area ⑦ ⑧, check configuration	Fault areas ④ ⑤ ⑥ ("loose contact")
114	<i>↔ 8.66 ↔</i> <i>↔ 10 ↔</i>	Temperature fluctuates, no calibration possible	Perform AUTOCAL and / or fault areas ④ ⑤ ⑥ ("loose contact")	Perform AUTOCAL and / or fault areas ④ ⑤ ⑥ ("loose contact")
115		Ext. calibration temp. too high, no calibration possible	Perform AUTOCAL with ext. calibration temperature ≤ 40 °C	Perform AUTOCAL with ext. calibration temperature ≤ 40 °C
116		Ext. calibration temp. fluctuates, no calibration possible	Perform AUTOCAL with stable ext. calibration temperature	Perform AUTOCAL with stable ext. calibration temperature

8.20 Fault areas and causes

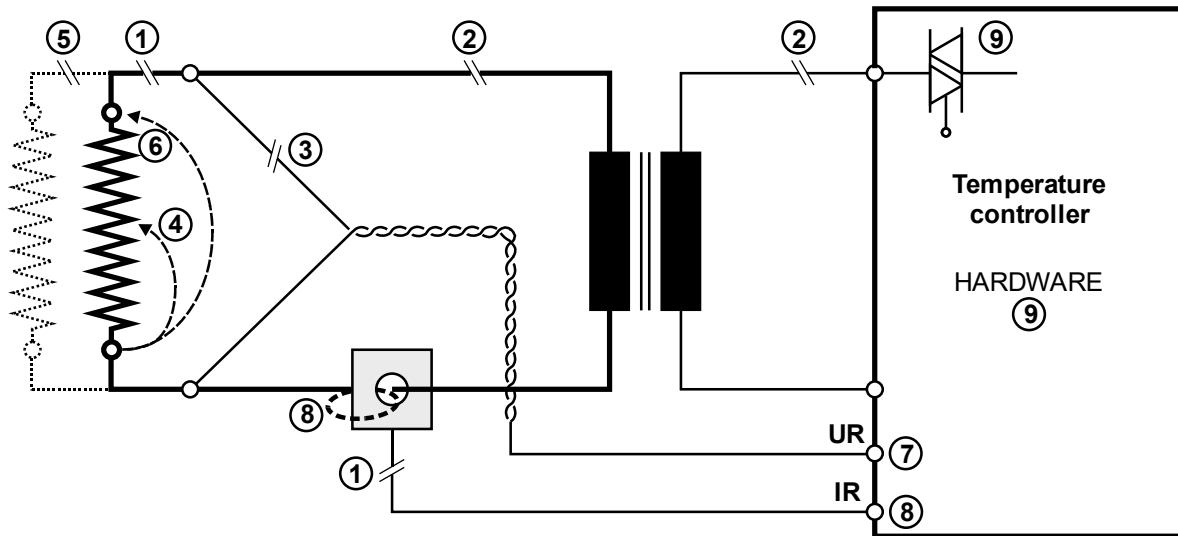



The table below explains the possible fault causes.

Fault area	Explanation	Possible causes
①	Load circuit interrupted after U_R pickoff point	- Wire break, heating element break - Contact to heating element is defective
	Current transformer signal interrupted	- I_R measurement cable from current transformer interrupted
②	Primary circuit interrupted	- Wire break, triac in controller defective - Primary winding of impulse transformer interrupted - Kb contactor open
	Secondary circuit interrupted before U_R pickoff point	- Wire break - Secondary winding of impulse transformer interrupted
③	No U_R signal	- Measurement cable interrupted
④	Partial short-circuit (ΔR)	- Heating element partially bypassed by conducting part (clamp, opposite heatsealing bar etc.)
⑤	Parallel circuit interrupted	- Wire break, heating element break - Contact to heating element is defective
⑥	Total short-circuit	- Heating element incorrectly installed, no insulation at heat-sealing bar ends or insulation incorrectly installed - Heating element completely bypassed by conducting part
⑦	U_R signal incorrect	- U_2 outside of permissible range from 0.4...120 VAC
⑧	I_R signal incorrect	- I_2 outside of permissible range from 30...500 A
	Wire incorrectly laid through current transformer	- Check number of turns (two or more turns required for currents < 30 A)



Fault area	Explanation	Possible causes
⑨	Internal device fault / no line voltage	<ul style="list-style-type: none"> - Hardware fault (replace controller) - Jumper for alarm relay not connected or incorrectly connected - No line voltage

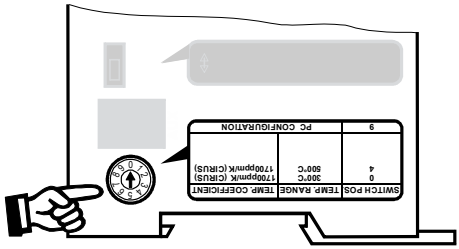
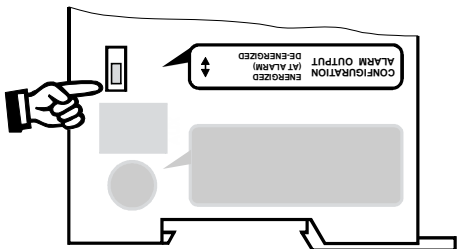

9 Factory settings

The CIRUS[®] UPT-6011 temperature controller is configured at the factory as follows:

<p><u>Rotary coding switch</u> for heating element alloy and temperature range</p>		<p>Heatsealing element alloy: 1700 ppm/K Temperature range: 300 °C</p> <p>Rotary coding switch: "0" position</p>
<p><u>Slide switch</u> for alarm relay</p>		<p>Alarm relay energized at alarm</p>
<p><u>Temperature diagnosis</u></p>		<p>Temperature diagnosis: Off</p>
<p><u>Heatup timeout</u></p>		<p>Heatup timeout: Off</p>

10 Technical data

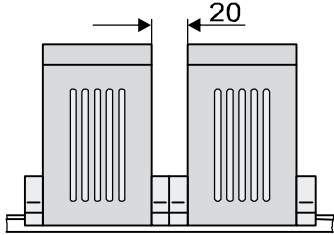
Type of construction	Housing for installation in an electrical cabinet Snaps onto a standard top hat rail (TS35 rail, 35 mm) acc. to DIN EN 50022 Dimensions: 90 x 75mm; depth: 135 mm (incl. terminals)
Line voltage	110 VAC -15%...300 VAC +10% Connected between neutral conductor and one line conductor or 110 VAC -15%...415 VAC +10% Connected between two line conductors  The voltage between the line conductor and ground must not be more than 300 VAC.
Power supply system	Balanced TN or TT system, max. 415 VAC Installation category III  Operation in potential-free systems (e.g. an IT system) is only permitted after consultation with ROPEX.
Line frequency	47...63 Hz, automatic adjustment to frequencies in this range
Current consumption (primary current of impulse transformer)	$I_{\max} = 5\text{ A}$ (duty cycle = 100%) $I_{\max} = 25\text{ A}$ (duty cycle = 20%, cycle duration 1 min)
24 VDC supply voltage Terminals 5+7	24 VDC, $I_{\max} = 200\text{ mA}$ Tolerance: $\pm 10\%$ SELV or PELV supplied from max. 300 VAC, Cat II
Measuring range	Secondary voltage U_R : 0.4...120 VAC Secondary current I_R : 30...500 A (with PEX-W4/-W5 current transformer) ↳ ROPEX Application Report
EtherNet/IP™ interface	2 Ethernet switch ports RJ45 Wiring: IEC 61784-5-3 Data transfer rate: 10 or 100 MHz Data transport layer: Ethernet II, IEEE 802.3 Addressing: DHCP or selectable with rotary coding switch ACD and DLR support: Yes
Heating element type and temperature range	The temperature range and temperature coefficient settings can also be specified in the ROPEX visualization software (↳ section 8.12 "USB interface for visualization software ROPEXvisual®" on page 58) in addition to using the rotary coding switch or via the EtherNet/IP™ interface (see below): Temperature range: 200 °C, 300 °C, 400 °C, or 500 °C Temperature coefficient: 400...4000 ppm/K (variable setting range) Two different ranges can be set using the rotary coding switch or via the EtherNet/IP™ interface: Temperature coefficient 1700 ppm/K, 0...300 °C (CIRUS) Temperature coefficient 1700 ppm/K, 0...500 °C (CIRUS)

Analog output (actual value) Terminals 17+18	0...10 VDC, $I_{\max} = 5 \text{ mA}$ Equivalent to 0...300 °C or 0...500 °C Accuracy: $\pm 1\%$ plus 50 mV
Alarm relay Terminals 12, 13, 14	$U_{\max} = 30 \text{ V (DC/AC)}$, $I_{\max} = 0.2 \text{ A}$, changeover contact, potential-free
Power loss	Max. 20 W
Ambient conditions	Max. altitude: 2000 m Ambient temperature: +5...+45 °C Max. relative humidity: 80% at temperatures up to +31 °C, decreasing linearly to 50% relative humidity at +45 °C
Degree of protection	IP20
UL file	E464680
Installation	<p>A minimum safety clearance of 20 mm all round (e.g. from other devices and wiring) must be allowed when installing the device.</p> <p>The moving clip required for fastening must be facing down for mounting on a horizontal top hat rail.</p> <p>End holders to mechanically fix the controller must be fitted at both ends for mounting on a vertical top hat rail.</p> 
Weight	Approx. 0.5 kg (incl. connector plug-in parts)
Housing material	Plastic, polycarbonate, UL-94-V0
Connecting cable Type / cross-sections	Rigid or flexible; 0.2...2.5 mm ² (AWG 24...12) Plug-in connectors Plug-in connectors: Tightening torque: 0.5...0.6 Nm (screwdriver: SZS 0.6x3.5 mm)  If ferrules are used, they must be crimped in accordance with DIN 46228 and IEC / EN 60947-1. This is essential to ensure proper electrical contact in the terminals.

11 Dimensions

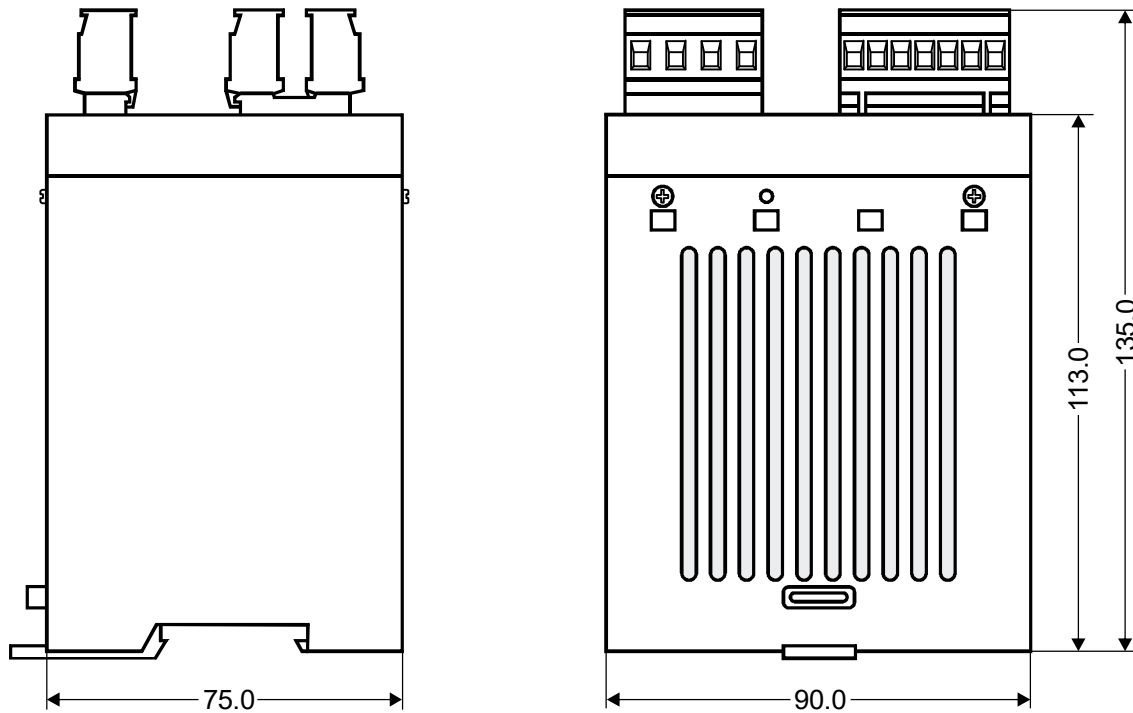

12 Modifications (MODs)

Owing to its universal design, the CIRUS[®] temperature controller UPT-6011 is suitable for a very wide range of heatsealing applications.

One modification (MOD) is available for the CIRUS[®] temperature controller UPT-6011 for implementing special applications.



The modifications must be ordered separately.

MOD 01

Booster for low secondary voltages ($U_R = 0.2 \dots 60 \text{ VAC}$). This modification is necessary, for example, for very short or low-resistance heating elements.

13 How to order

	<p>Controller UPT-6011 Power supply 115...400 VAC, Art. No. 7601100</p> <p>Scope of supply: Controller includes connector plug-in parts (without current transformer)</p> <p>Modification MOD . . (optional, if required)  e.g.  01: MOD 01, Art. No. 800001 (booster for low voltage)</p> <p>Please indicate the article numbers of the controller and the required modifications (optional) in all orders, e.g. UPT-6011 + MOD 01 (controller with booster for low voltage) Order of art no. 7601100 + 800001 must be ordered</p>
	<p>Current transformer PEX-W5 Art. no. 885107</p>
	<p>Monitoring current transformer MSW-2 Art. no. 885212</p>
	<p>Network filter LF-  06480: Continuous current 6 A, 480 VAC, art. no. 885500 (with UL certification) 10520: Continuous curr. 10 A, 520 VAC, art. no. 885504 (with UL and CSA certification) 35480: Continuous curr. 35 A, 480 VAC, art. no. 885506 50520: Continuous curr. 50 A, 520 VAC, art. no. 885509 (with UL and CSA certification)</p>
	<p>Impulse transformer</p> <p>For design and order specifications, see ROPEX application report Design in accordance with EN 61558 Available with UL certifications and thermal switch, if necessary. In addition, we can individually design and offer you an upstream transformer.</p>
	<p>Temperature meter ATR - .  3: 300 °C range, art. no. 882130  5: 500 °C range, art. no. 882150</p>

	<p>Booster B- . . .</p> <p>→ 075415: Impulse loaded 75 A, 415 VAC, art. no. 885302 100400: Impulse loaded 100 A, 400 VAC, art. no. 885304</p>
	<p>Lines</p> <p>For design and order specifications, see ROPEX application report</p>

14 Index

Numbers

24 VDC supply voltage 67

A

AA bit 25
AC bit 23
Actual value 27
Actual value output 57
AG bit 25
AL bit 19, 25
Alarm output 60
Alarm relay 18, 68
Alloy 17
Altitude 68
Ambient conditions 68
Ambient temperature 68
Application 6
Application Report 9, 12
AUTOCAL 8, 19
 Active 25
 Blocked 23, 25
 Starting 23
Automatic zero calibration 19, 23
Automatic zeroing 8
AUX interface 59

B

Booster 15, 71
Booster connection 58

C

Circuit-breaker 11
Co (correction factor) 49
Commissioning 19
Control active 27
Correction factor Co 49
Current transformer 4, 12, 70

D

Data format 49
Data memory 59
Date 59
Degree of protection 68
Device description file (EDS) 22
Dimensions 69
Disposal 5

E

EDS file 22
Error code format 50
Error diagnosis 8
Error messages 61
EtherNet/IP interface 67

External switching amplifier 15

F

Factory settings 66
Fault 25
Fault areas 65
Fuse 11

H

Heating element 4, 18
Heating element type 67
Heatup timeout 51

I

Impulse transformer 4, 11, 70
Input data 23
Installation 9, 68
Installation procedure 9
Installation regulations 10

L

Line filter 4, 11, 12
Line frequency 67
Line voltage 67

M

Maintenance 5
Master AUTOCAL (MA) 24
Measurement interruption 22, 27
Measurement pause 24
Measuring impulse duration 49
Measuring range 67
Modification MOD 69, 70
Monitoring current transformer 70
MP bit 24
MSW-2 70
MU bit 27

N

Network filter 70
Network frequency 8

O

Output data 25
Over-current protection 11

P

PEX-W4/-W5 4, 12
PEX-W5 70
Power loss 68
Power supply 11
Power supply system 67

R

RA bit 19, 27
Relative humidity 68
Replacing the heating element 18
Reset 24
ROPEXvisual 58
RS bit 24

S

Set point 25
ST bit 19
Standby mode 56
Start 24
Start temperature 50
Startup 16
System diagnosis 58
System monitoring 60

T

TCR 18
TE bit 26
Temperature achieved 26
Temperature coefficient 18
Temperature diagnosis 50, 51

Temperature meter 58, 70
Temperature OK 26
Temperature range 17, 67
Thermal impulse process 6
Time 59
Timestamp 59
TO bit 26
Transformer 4, 11, 70
Transportation 5
Type of construction 67

U

UL file 68
USB interface 58

V

View of the device 16
Visualization software 58

W

Web server 52
Wiring 10, 11
Wiring diagram 14, 15