

Linear Line

Telescopic Line

Actuator Line

Actuator System Line



Product Overview
English

Interactive catalogs
on: www.rollon.com



TO SUPPORT YOU, WE DESIGN AND PRODUCE

An industrialized process with various levels
of customization



For over 40 years, Rollon has adopted an approach entailing responsibility and ethics in the design and production of our linear motion solutions for different industrial sectors. The reliability of an international technology group has now been combined with the availability of a local support and service network



VALUES



PERFORMANCE



Rollon's goal is to help our clients become more competitive in their markets through technological solutions, design simplification, productivity, reliability, duration, and low maintenance.

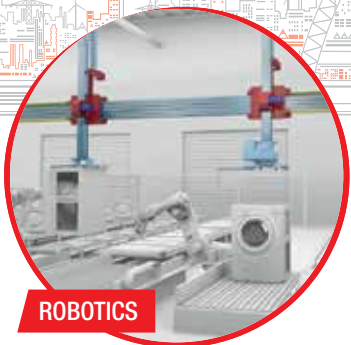

ROBOTICS



INDUSTRIAL MACHINERY



LOGISTICS



RAILWAY

COLLABORATION



High-level technical consulting and cross-competence allow us to identify the needs of our clients and transform them into guidelines for continuous exchange, while our strong specialization in the different industrial sectors becomes an factor in developing projects and innovative applications.

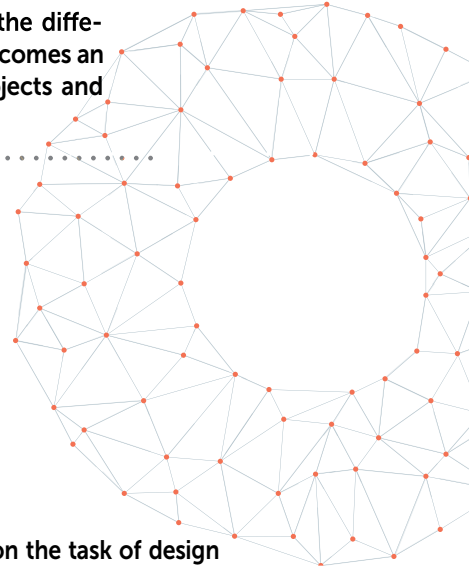

Rollon takes on the task of design and development of linear motion solutions, taking care of everything for our customers, so that they can concentrate on their core business. We offer everything from individual components to specifically designed, mechanically integrated systems: the quality of our applications is an expression of our technology and competence.

SOLUTIONS APPLICATIONS



INTERIORS AND ARCHITECTURE

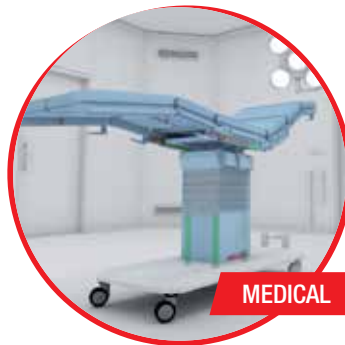

MEDICAL



SPECIAL VEHICLES



AERONAUTICS

DIVERSIFIED LINEAR SOLUTIONS FOR EVERY APPLICATION REQUIREMENT

Linear and telescopic rails

Linear Line



Linear and curved rails with ball and roller bearings, with hardened raceways, high load capacity, self-alignment, and capable of working in dirty environments.

Telescopic Line



Telescopic rails with ball and roller bearings, with hardened raceways, high load capacities, low bending, resistant to shocks and vibrations. For partial, total or extended extraction up to 200% of the length of the guide.

Linear actuators and automation systems

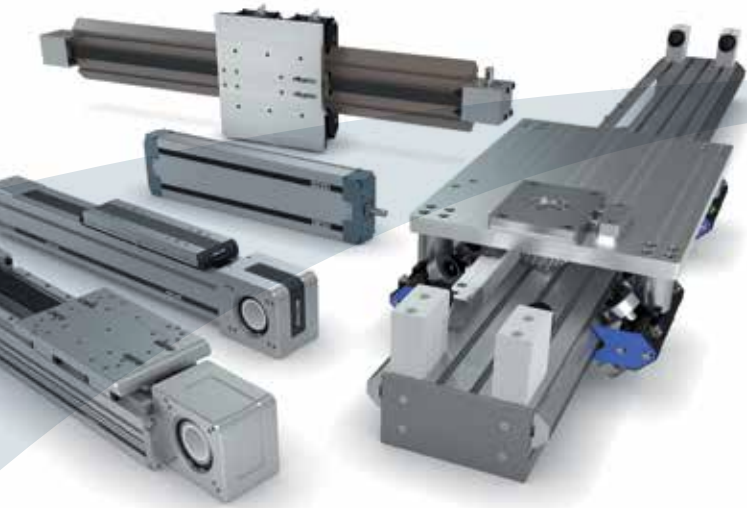

Actuator Line

Linear actuators with different rail configurations and transmissions, available with belt, screw, or rack and pinion drives for different needs in terms of precision and speed. Rails with bearings or ball recycle systems for different load capacities and critical environments.

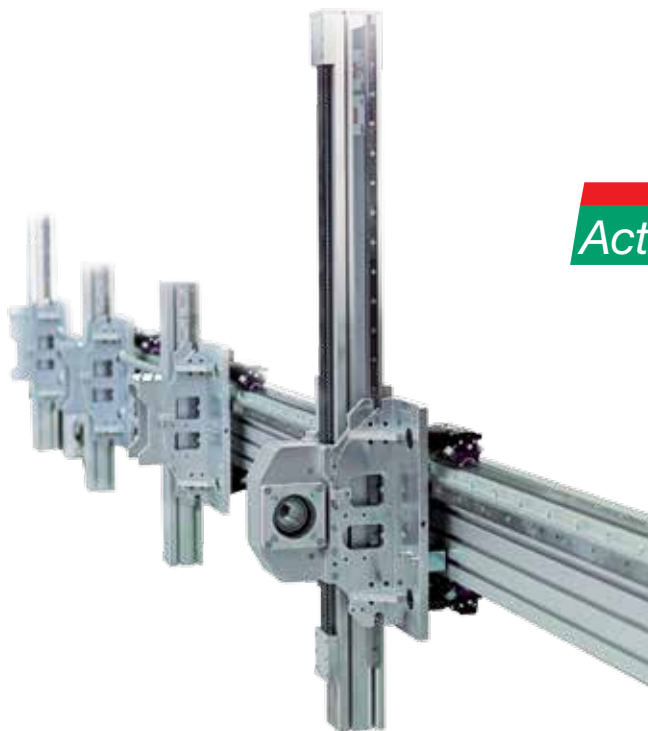

Actuator System Line

Integrated actuators for industrial automation, used in applications in several industrial sectors: automated industrial machinery, precision assembly lines, packaging lines and high speed production lines. The Actuator Line evolves to satisfy the requests of our most discerning clients.

Compact Rail

Self-aligning linear guides with bearings and a C-profile made of cold-drawn carbon steel. They have induction hardened and ground raceways.

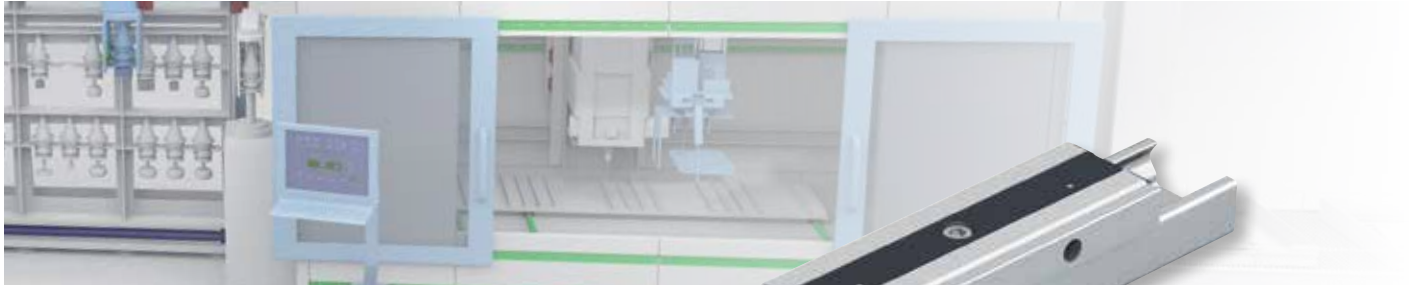

Resistant to corrosion



Optimal reliability in dirty environments.



Long life thanks to hardened raceways.



Low maintenance



Uniquely quiet with ground raceways.



Solid and sturdy thanks to steel slider body



Self-aligning systems on two planes: axially up to 3.9 mm, radially up to $\pm 2^\circ$.

High dynamics due to roller bearing:
 $V = 9\text{m/s}$, $A = 20\text{m/s}^2$



Available with double row ball bearings for high load capacities.

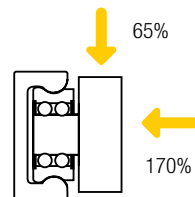

* Example referred to size 43.

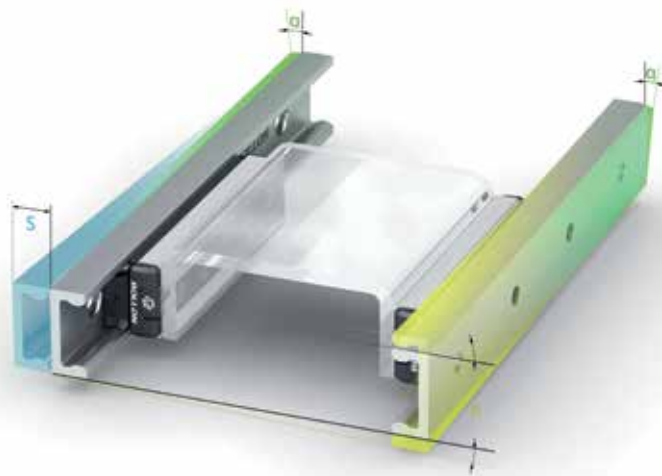

Linear Line

X-Rail

Linear bearings with bended C-profile. Available in zinc-plated steel, stainless steel or hardened with Rollon NOX treatment.



Available with Rollon NOX hardening process.



Optimal reliability in dirty environments.



Cost effective bended steel profiles.



Simple mounting.



Self-aligning system.



Anticorrosion.

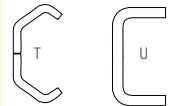

Up to 3,5 mm

Easyslide

Smooth linear guides with balls and a C-profile made of cold-drawn carbon steel. They have induction hardened raceways.

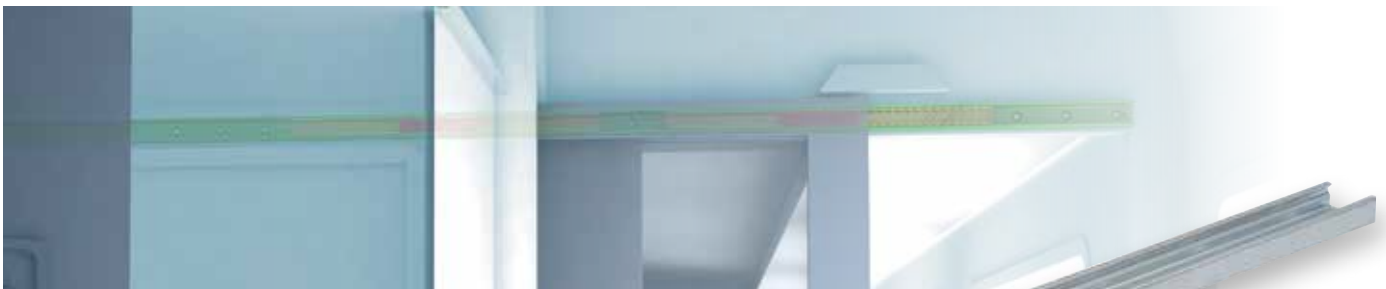

High loads up to 12.000 Kg. per slider.



Mounting and alignment even on imprecise surface.



Long life thanks to hardened raceways.



Space saving solution with internal slider.

Curviline

Customized guides for constant and variable radius. Available as stainless steel and hardened or unhardened steel version.



Stainless Steel
Anticorrosion.



Design freedom due to constant and variable radius.



Long life thanks to hardened raceways.

O-Rail

Modular linear guides with rollers. Versatile for the highest flexibility of configurations.

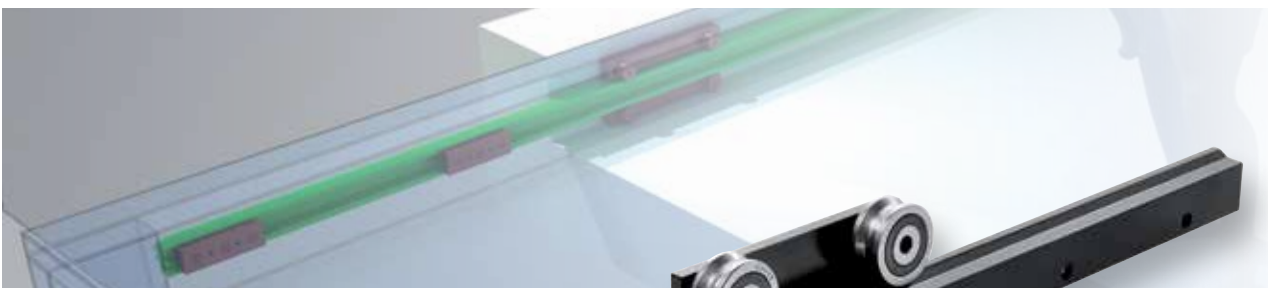

Versatile for multiple configurations and combinations.



Resistant to wear through the Rollon NOX hardening process.



High load capacity due to double row bearings.



Simple mounting.



Self-aligning system:

axial ± 1 mm, rotational $\pm 5^\circ$

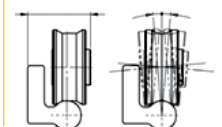

Linear Line

Prismatic Rail

Prismatic rails with bearings. They're available with cylindrical rollers or with V-shaped rollers configuration.

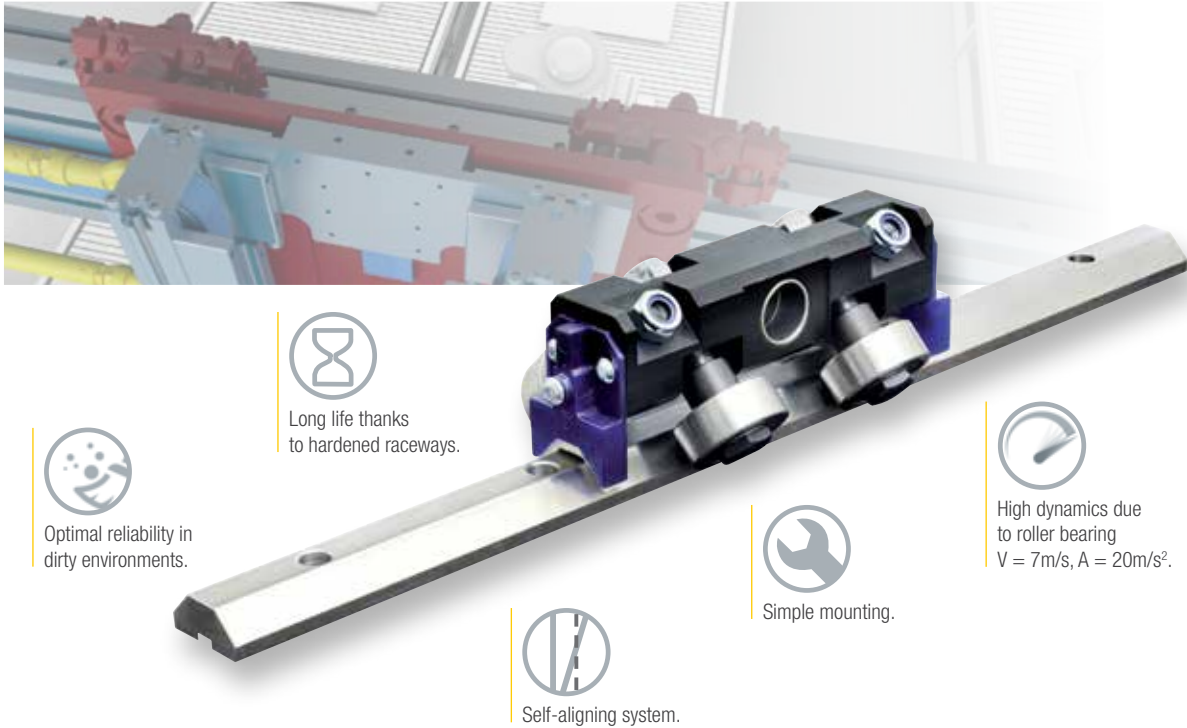

Optimal reliability in dirty environments.



Long life thanks to hardened raceways.



High dynamics due to roller bearing
 $V = 7\text{m/s}$, $A = 20\text{m/s}^2$.



Simple mounting.



Self-aligning system.

Speedy Rail

Self-supporting and self-aligning extruded aluminum linear guides. The slider is supported by steel bearings covered by plastic compound, available in cylindrical or V-shaped configuration.

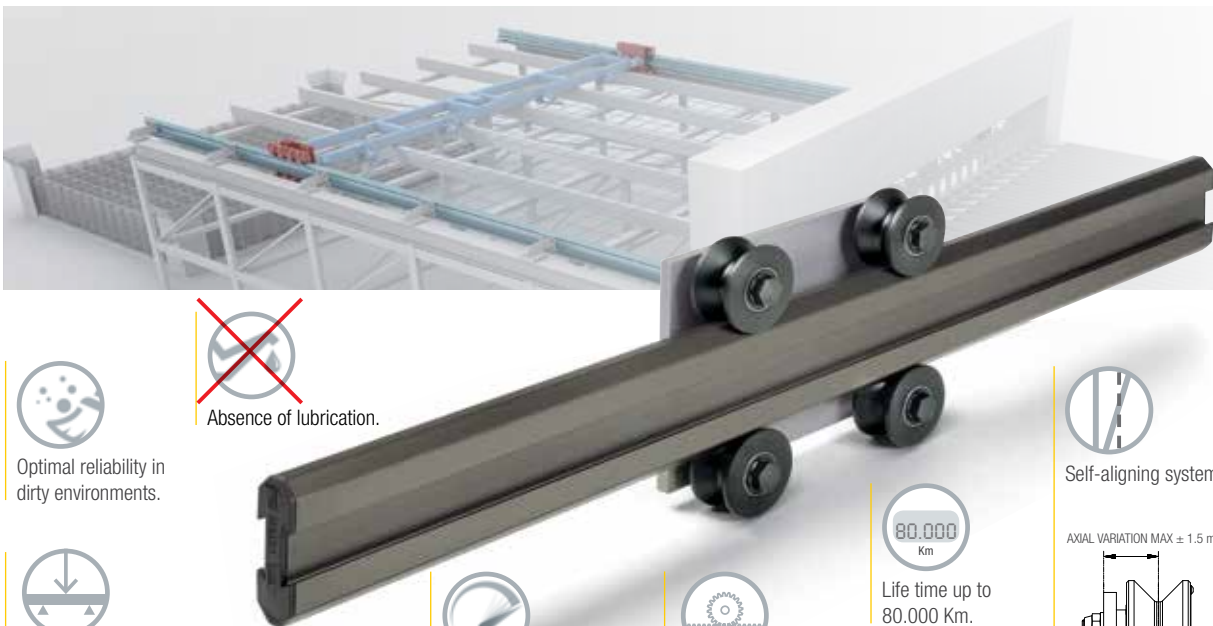

Optimal reliability in dirty environments.



Absence of lubrication.



Self-supporting for greatest design freedom.



High dynamics:
 $V = 15\text{m/s}$, $A = 10\text{m/s}^2$.



Use as a linear guide or actuator.



Life time up to 80.000 Km.



Self-aligning system.

AXIAL VARIATION MAX $\pm 1.5\text{ mm}$

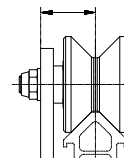

AXIAL VARIATION MAX $\pm 4\text{ mm}$

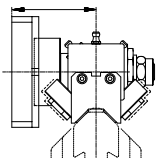

Mono Rail

Recirculating balls linear guides. They have ground raceways and a ball contact angle of 45° in X-arrangement.

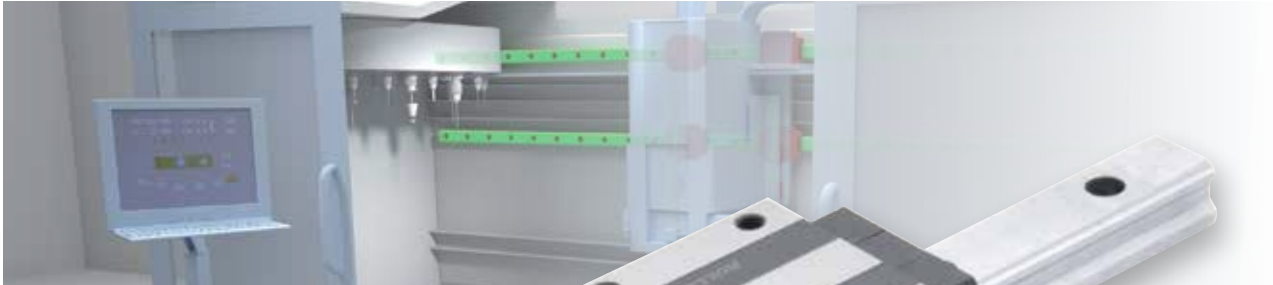

Long life thanks to hardened raceways.



High stiffness and precision with recirculating balls system.



High loads up to 24.000 Kg. per slider.

Technical features overview



Reference		Section	Shape of rail	Hardened raceways	Rollon NOX hardening process *3	Self-alignment	Slider		Anticorrosion
Product Family	Product						Balls	Rollers	
Compact Rail		TLC KLC ULC		✓		+++			****
		TG/TMG PLUS		✓	✓	+++			****
X-Rail		TEX TES UES UES				+++			Available in stainless steel
		TEN/TEP UEN			✓	+++			
Easyslide		SN		✓		++			****
		SNK		✓		+			****
Curviline		CKR CVR CKRH CVRH CKRX CVRX		✓		+			Available in stainless steel
O-Rail		FXRG			✓	+++			****
Prismatic Rail		P		✓		+++			
Speedy Rail		SR35		✓		++			
		SRC48		✓		+			
		SR		✓		+++			
Mono Rail		MR		✓		-			
		MMR		✓		-			****

Reported data must be verified according to the application.

*1 The maximum value is defined by the application.

*2 A longer stroke is available for jointed versions.

*3 High dept nitride hardening treatment and oxidation.

*4 Value referred to a single bearing, it's possible to configure the numbers of bearings to obtain the desired load capacity.

***C50

****For more information, please contact our technical department.

Size	Max. load capacity per slider [N]		Dynamic coefficient [N] C 100	Max. moment capacity [Nm]			Max. rail length [mm]	Max. speed* [m/s]	Max. acceleration [m/s ²]	Operating temperature
	C ₀ rad	C ₀ ax		M _x	M _y	M _z				
18-28-35 -43-63	15000	10000	36600	350	689	1830	4080* ²	9	20	-20°C/+120°C
18-28-43	10800	7140	15200	110.7	224.3	754	4000* ²	7	15	-20°C/+120°C
20-26-30-40-45	1740	935	****				4000	1.5	2	-20°C/+100°C TEX-UEX -20°C/+120°C TES-UES
TEN: 26-40 TEP: 30 UEN: 40	3240	1150	3670				4000	1,5	2	-30°C/+170°C
22-28-35 -43-63	122000	85400	122000	1120,7	8682	12403	1970	0,8		-20°C/+130°C
43	10858	7600	10858	105	182	261	2000* ²	1,5		-20°C/+70°C
16,5-23	2475	1459	****				3240	1,5	2	-20°C/+80°C
12	4000* ⁴	1190* ⁴	7600* ⁴				4000	9	20	-40° C / + 130° C
28-35-55	15000	15000	-	-	-	-	4100* ²	7	20	-10°C/+80°C
35	400	400	-	-	-	-	6500* ²	8	8	-30° C / + 80° C
48	540	400	-	-	-	-	7500* ²	8	8	-30° C / + 80° C
60-90-120- 180-250	14482	14482		-	-	-	7500* ²	15	10	-30° C / + 80° C
15-20-25-30-35- 45-55	249000		155000***	5800	6000	6000	4000* ²	3,5	20	-10°C/+60°C
7-9-12-15	8385		5065	171,7	45,7	45,7	1000* ²	3	250	-20°C/+80°C



Telescopic Line



Telescopic Rail

Heavy duty telescopic rails with hardened raceways for extractions up to 150%. Available with different shapes according to load capacity and rigidity required.

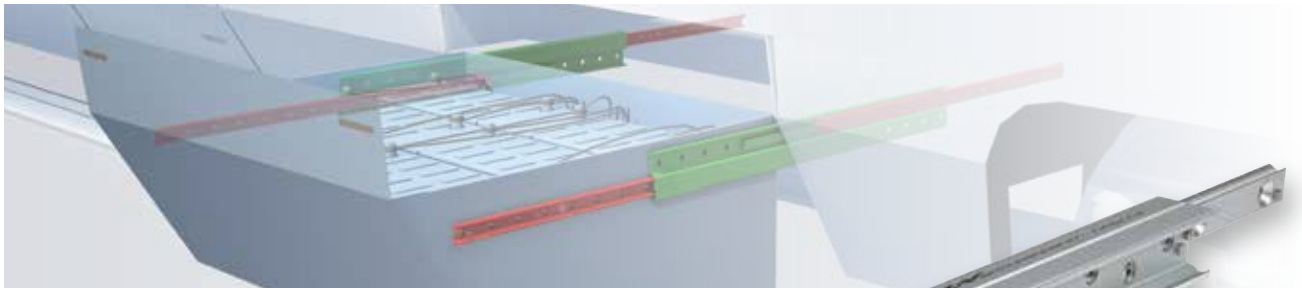

Long life thanks to hardened raceways.



High loads up to 3.800 Kg. per pair of guides.



Extractions up to 150%



Wide range of anticorrosion surface treatments.



Safe solutions with locking and damping systems.



Suitable for automation with rack and pinion synchronization available.



Low deflection due to sturdy profiles.

Hegra Rail

Industrial telescopic rails for extractions up to 200%. Stainless steel and aluminum versions available.



High loads up to 2.000 Kg. per pair of guides.



Safe solutions with locking and damping system.



Anticorrosion.



Low deflection due to sturdy profiles.



Aluminum available for lightweight construction.



Overextraction up to 200%.

Telescopic Line

Telerace

Telescopic guides with bearings, suitable for vertical strokes and variable stroke working cycles.



Stainless Steel

Available with stainless steel bearings.



Suitable for vertical and variable strokes.



Ideal for continuous working cycles with low maintenance.



Optimal reliability in dirty environments.



High load capacity due to double row bearings.



Uniquely quiet with ground raceways.

Light Rail

Bended steel telescopic rails with light structure for extractions up to 100%.

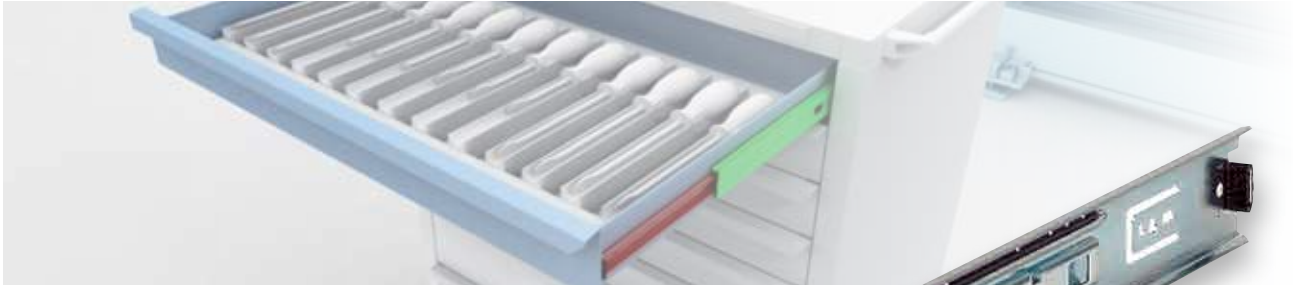

Good rigidity in relation to a lightweight design.



Stainless steel available.



Quiet sliding.



Space saving. Ideal for medium and lightweight drawers.

Technical features overview



Reference			Product name	Extraction	Size	Profile		Self alignment	Slider		Steel
Product Family	Product	Section				Type	Hardened raceways		Balls	Rollers	
Telescopic Rail	ASN		ASN22		22	Cold Draw	■	+	■		■
			ASN28		28						
			ASN35		35						
			ASN43		43						
			ASN63		63						
	DE		DE...22		22	Cold Draw	■	++	■		■
			DE...28		28						
			DE...35		35						
			DE...43		43						
			DE...63		63						
			DE...28S		28						
			DE...35S		35						
			DE...43S		43						
			DE...28D		28						
			DE...35D		35						
			DE...43D		43						
			DE...63D		63						
			DS								
	DSS35	35									
	DSS43	43									
	DSS63	63									
	DSS43S	43									
	DSB28	28									
	DSB35	35									
	DSB43	43									
	DSD28	28									
	DSD35	35									
	DSD43	43									
DSC		DSC43		43	Cold Draw	■	++	■		■	
		DSC43		43							
DBN		DBN22		22	Cold Draw	■	++	■		■	
		DBN28		28							
		DBN35		35							
		DBN43		43							
DMS		DMS63		63	Cold Draw	■	++	■		■	
DSE		DSE28		28	Cold Draw	■	++	■		■	
		DSE35		35							
		DSE43		43							
		DSE63		63							

Reported data must be verified according to the application.

* The maximum value is defined by the application. For more information, please contact our technical department.

■ standard

X steel
A stainless steel
aluminum

B stroke in both directions
BM stroke in both directions with driving disc



Material		Stroke direction		Snap	Locking closed position	Damping closed position	Max. load capacity per pair [N]		Max. rail length [mm]	Max. stroke [mm]	Max. extension speed* [m/s]	Rigidity (deflection)	Operating temperature [°C]
X	A	B	BM				C _{0rad}	C _{0ax}					
		■					5934	4154	770	394	0,8	+++	-20°C/+170°C
		■					15736	11014	1170	601	0,8		
		■					26520	18564	1490	759	0,8		
		■					48596	34018	1970	1013	0,8		
		■					88494	61946	1970	1013	0,8		-20°C/+170°C
		■					1348	546	770	788	0,8		
		■					2338	1074	1170	1202	0,8		
		■					3816	1586	1490	1518	0,8		
		■					6182	2868	1970	2026	0,8	+++	-20°C/+50°C
		■					14396	6124	1970	2026	0,8		
					■		2100	758	1170	1186	0,8		
					■		3540	1574	1490	1510	0,8		
							5964	2522	1970	2066	0,8		-20°C/+170°C
			■				2014	856	1170	1216	0,8		
			■				3460	1534	1490	1503	0,8		
			■				5784	2484	1970	2011	0,8		
			■				15512	6514	1970	1962	0,8	++++	-20°C/+80°C
					■		7524	3830	1970	1923	0,8		
					■		4480	-	1490	1518	0,8		
					■		7016	-	1730	1758	0,8		
							9816	-	1970	2026	0,8		-20°C/+50°C
							25664	-	1970	2026	0,8		
							10208	-	1970	2026	0,8		
					■		4480	-	1490	1518	0,8		
					■		7016	-	1730	1758	0,8	-20°C/+80°C	
					■		9816	-	1970	2026	0,8		
		■					5162	-	1490	1446	0,8		
		■					9736	-	1730	1630	0,8		
		■					11660	-	1970	1916	0,8		
		■					38018	-	1970	1758	0,8		
						■	11058	4150	1970	2028	0,8	+++	-20°C/+80°C
		■					562	472	770	788	0,8	+	-20°C/+170°C
		■					1244	1074	1170	1202	0,8		
		■					1334	1120	1490	1518	0,8		
		■					2662	2558	1970	2026	0,8		
						■	39624	-	2210	2266	0,8	++++	-20°C/+80°C
							1702	-	1170	1803	0,8	++++	-20°C/+80°C
							3182	-	1490	2277	0,8		
							5012	-	1970	3039	0,8		
							11344	-	1970	3039	0,8		

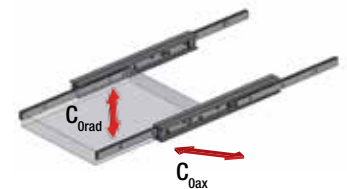

Technical features overview



Reference			Product name	Extraction	Size	Profile		Self alignment	Slider		Steel
Product Family	Product	Section				Type	Hardened raceways		Balls	Rollers	
Hegra Rail		HTT		HTT030		30	Machined		+	●	●
				HTT040		40					
				HTT050		50					
		HVC		HVC045		45	Bended sheetmetal & cold drawn		++	●	●
				HVC050		50					
				HVC058		58					
				HVC075		75					
		H1C*1		H1C075		75	Machined, cold drawn & bended sheetmetal		++	●	●
		H1T*1		H1T060		60	Machined & cold drawn		++	●	●
				H1T080		80					
				H1T100		100					
				H1T150		150					
		H2H		H2H080		80			++	●	●
		LTH		LTH30		30	Cold drawn		++	●	●
				LTH45		45					
				LTH30S		30					
				LTH45S		45					
		HGT		HGT060		60	Machined & cold drawn		++	●	●
				HGT080		80					
HGT100				100							
HGT120				120							
HGT150				150							
HGT200				200							
HGT240				250							
	LTF		LTF44		44	Cold drawn		++	●	●	
	HGS		HGS060		60	Machined		++	●	●	

Reported data must be verified according to the application.

In many cases, special designs or alternative surface coatings are possible. For more information, please contact our technical department.

*1 The over extension corresponds to 150 % stroke (1=150 % extraction). For a 200 % stroke (2=200 % extraction) please contact our technical department.

*2 Different temperature ranges from -30 °C to +250 °C, This must be verified according to the application.

*3 The load capacity for aluminum is 40 % and for stainless steel 60 % of the stated values, if available in this material variant.

*4 Different stainless steels, such as the «electropolishing» option, are available. For more information, please contact our technical department.

*5 The availability of locking systems depends on the system length and varies per product group. For more information, please contact our technical department.

*6 The operating temperature is maximum +50°C if damping is used. For more information, please contact our technical department.

*7 The maximum value is defined by the application. For more information, please contact our technical department.

- feasible
- ▲ only to length 1000
- standard

Material		Stroke direction			Snap			Locking*5			Damp- ing	Max. load capacity per pair [N]		Max. rail length [mm]	Max. stroke [mm]	Max. extension speed*7 [m/s]	Rigidity (deflection)	Operating temperature*2*6 [°C]
X*4	A	B	BM	EG	EO	EB	VG	VO	VB	DG	C _{0rad} *3	C _{0ax}						
•	•	•		•	•	•				■	1200	on request	1000	660	0,8	+++	-20°C/+170°C	
				•	•	•				■	2550		1000	660				
				•	•	•	•	•	•	■	2900		1200	720				
											1200	on request	1200	1200	0,8	+	-20°C/+170°C	
•		•	•	•	•	•	•	•	•	•	1500		1500	1500				
				•	•	•	•	•	•	•	2100		1500	1500				
											3300		2000	2000				
			•		•	•	•			•	1350	-	1500	2250	0,5	+	-20°C/+170°C	
•	•	•		•	•	•				•	2600	-	1500	2250	0,5	++	-20°C/+170°C	
				•	•	•				•	3200	-	1500	2250				
										•	5500	-	2000	3000				
										•	7500	-	2000	3000				
•	•			•	•	•				•	on request	-	2000	3000	0,5	++	-20°C/+170°C	
											1470	on request	1200	1215	0,5	++	-20°C/+170°C	
											3346		1500	1522				
										•	1498		1200	1217				
										•	3084		1500	1522				
•	•	•	•	•	•	•	•	•	•	•	5500	on request	1500	1500	0,5	+++	-20°C/+170°C	
				▲	▲	▲					9350		2000	2000				
											11000		2000	2000				
											11800		2000	2000				
											13900		2000	2000				
											17500		2300	2300				
											20000		2000	2000				
			•								1296	-	1010	1010	0,3	+	-20°C/+170°C	
	•	•		•	•	•					1400	-	1000	1000	0,5	+++	-20°C/+170°C	

X steel
 stainless steel
 A aluminum

B stroke in both directions
 BM stroke in both directions with driving disc

EG snap on closed position
 EO snap on opened position
 EB snap on both positions

VG locking closed position
 VO locking opened position
 VB locking both positions

DG damping closed position

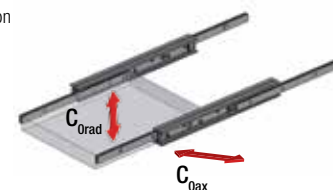

Technical features overview



Reference			Product name	Extraction	Size	Profile			Self alignment	Slider				
Product Family	Product	Section				Type	Hardened raceways	Rollon-Nox treatment* ¹		Balls	Rollers	Steel		
Telerace		TLR...G		TLR18		100%	18	Cold Draw	■		+++	■	■	
				TLR28G										28
				TLR43G										43
		TLQ...G		TLQ18FF		80% A 120%	18	Cold Draw	■		+	■	■	
				TLQ28G										28
				TLR43G										43
		TLN		TLN30		100%	30	Formed Sheetmetal		■	+	■	■	
				TLN40										40
		TON		TON30		80% A 120%	30	Formed Sheetmetal		■	+	■	■	
				TON40										40
		TLAX		TLAX26		100%	26	Formed Sheetmetal			+	■		
				TLAX40										40
		TQAX		TQAX26		80% A 120%	26	Formed Sheetmetal			+	■		
				TQAX40										40

Reported data must be verified according to the application.

*¹ High dept nitride hardening treatment and oxidation.

*² Also available in TLN.HP version with greater load capacity.

*³ The maximum value is defined by the application. For more information, please contact our technical department.

■ standard

steel

X stainless steel

A aluminum

B

stroke in both directions
BM stroke in both directions with driving disc

Reference			Product name	Extraction	Size	Profile		Self alignment	Slider				
Product Family	Product	Section				Type	Hardened raceways		Balls	Rollers	Steel		
Light Rail		LPS		LPS38		50%	38	Formed Sheetmetal		++	■	■	
				LFS46									46
		LFS		LFS57		100%	57	Formed Sheetmetal		++	■	■	
				LFS58									58
				LFS70									70
	LFX		LFX27		100%	27	Formed Sheetmetal		++	■			

Reported data must be verified according to the application.

* The maximum value is defined by the application. For more information, please contact our technical department.

■ standard

steel

X stainless steel

A aluminum

B

stroke in both directions
BM stroke in both directions with driving disc

Material		Stroke direction		Suitable for variable stroke cycles	Suitable for vertical stroke	Damping closed position	Max. load capacity per pair [N]		Max. rail length [mm]	Max. stroke [mm]	Max. extension speed* ³ [m/s]	Rigidity (deflection)	Operating temperature [°C]
X	A	B	BM				C _{Orad}	C _{Oax}					
				■		■	1304	-	770	770	1,0	++++	-20 °C/+110 °C
							3264	-	1490	1500			
							7672	-	1970	1980			
				■	■	■	946	426	770	770	1,0	+++	-20 °C/+110 °C
							2058	808	1490	1490			
							4978	1784	1970	1970			
				■		■	1776* ²	-	1490	1500	1,0	++++	-20 °C/+80 °C
							3648* ²	-	1970	1980			
				■	■	■	1362	476	1490	1490	1,0	+++	-20 °C/+80 °C
							2592	906	1970	1970			
■				■		■	1330	-	1200	1200	1,0	++++	-20 °C/+80 °C
							2422	-	1600	1600			
■				■	■	■	1008	352	1200	1200	1,0	+++	-20 °C/+80 °C
							2170	760	1600	1600			

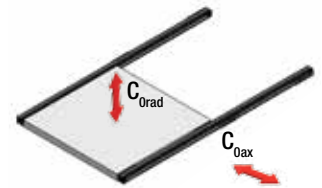

Material		Stroke direction		Snap closed position	Locking	Damping closed position	Max. load capacity per pair [N]		Max. rail length [mm]	Max. stroke [mm]	Max. extension speed* [m/s]	Rigidity (deflection)	Operating temperature [°C]
X	A	B	BM				C _{Orad}	C _{Oax}					
							350	100	473	373	0,5	+	+10 °C/+40 °C
						■	400	100	600	610	0,5	+	+10 °C/+40 °C
						■	800	160	750	800			
				■		■	600	-	550	584			
						■	2000	300	1100	1100			
■							350	50	550	576	0,5	+	-30 °C/+200 °C

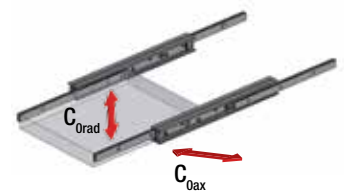

Actuator Line

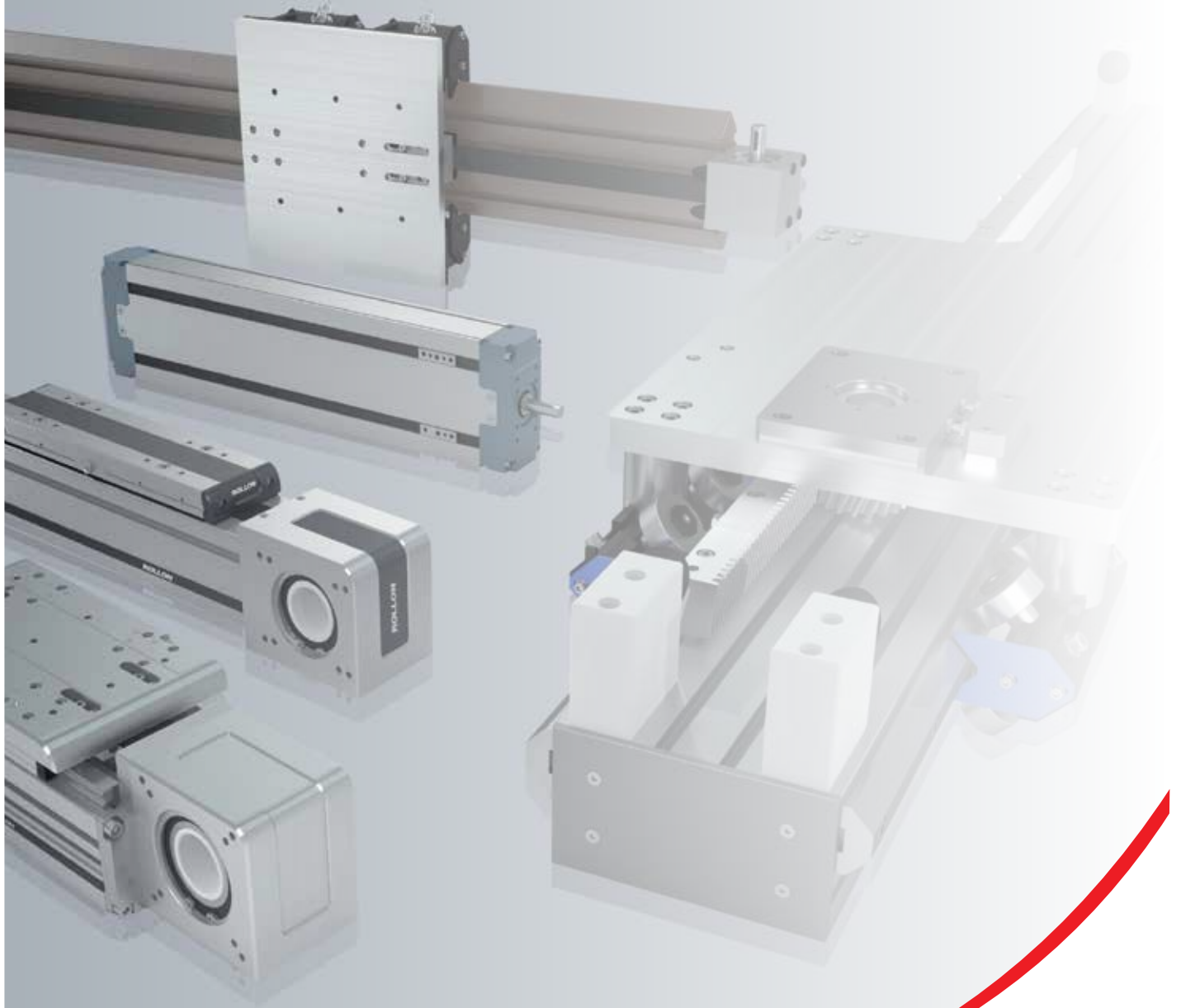

Plus System

High performance linear actuators with steel re-enforced driving belt transmission. They have a high level of protection.



High protection for dirty environments.



Anti-corrosion version available with stainless steel components.



High working cycles.



High repeatability accuracy:
 $\pm 0,05$ mm



High dynamics:
 $V=5$ m/s, $A= 50$ m/s².



Available with fixed carriage and movable profile for Z axis solutions.

Clean Room System

Clean Room certified belt driven linear actuators.



High repeatability accuracy:
 $\pm 0,05$ mm



Anti-corrosion version with components made of stainless steel or suitable surface treatment.



High dynamics:
 $V=5$ m/s, $A= 50$ m/s².



Low particles emissions thanks to vacuum system

Actuator Line

Smart System

Qualitative and cost effective belt driven linear actuators.

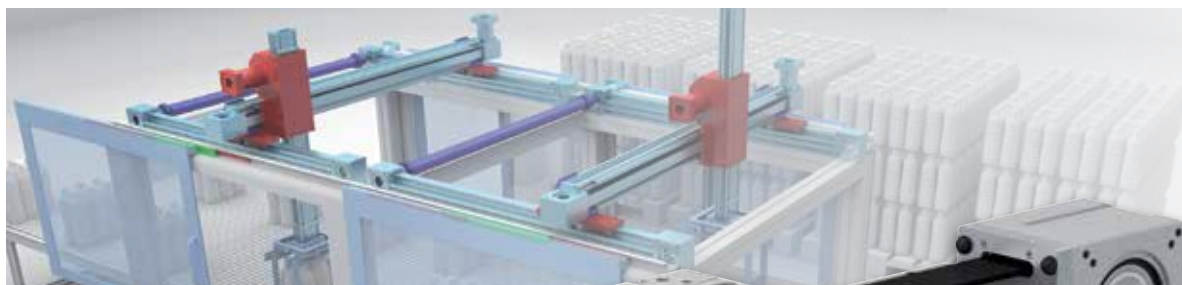

Available with fixed carriage and movable profile for Z axis solutions.



High repeatability accuracy:
 $\pm 0,05$ mm.



High dynamics:
 $V=4$ m/s, $A= 50$ m/s².



Simple structure
for effective cost.



High load capacity with
recirculating ball guides.

Eco System

Simple and protected belt driven linear actuators.



Simple structure
for effective cost.



High dynamics:
 $V=5$ m/s, $A= 50$ m/s².



Lightweight thanks
to aluminum profile.



High repeatability accuracy:
 $\pm 0,05$ mm.

Uniline System

Belt driven actuators with radial ball bearing sliders.

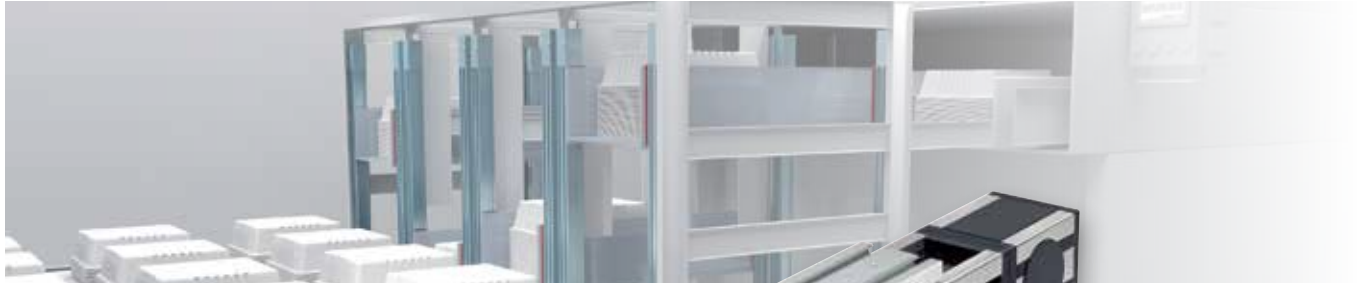

High speed:
V=9 m/s.



Optimal reliability in
dirty environments.



Long life and
low maintenance.



Grease free operations possible.



Compact Rail linear guides inside.

Modline

Versatile belt driven linear actuators. They've recirculating ball guides or prismatic roller bearings.



Available with fixed carriage and movable
profile for Z axis solutions, even with
patented pneumatic counterbalance system.



Patented short belt solution for
very long multi-axes systems.



Versatile for multiple
configurations.



Optimal reliability in dirty environments
and high working cycles.



Wide range of aluminum profile
sizes up to 360 mm.



Available with recirculating ball guides
or prismatic roller bearings.

Actuator Line

Precision System

High precision ball screw driven actuators.

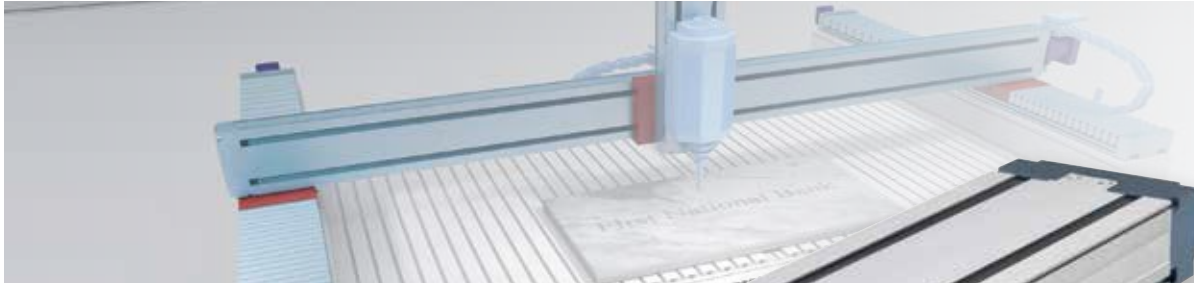

Simple and safe maintenance through separate lubrication for ball screw drive and guides.



Space saving thanks to compact design.



High repeatability accuracy: till $\pm 0,005$ mm



High protection for dirty environments.

Tecline

Rack and pinion driven linear actuators. They've recirculating ball guides or prismatic roller bearings.

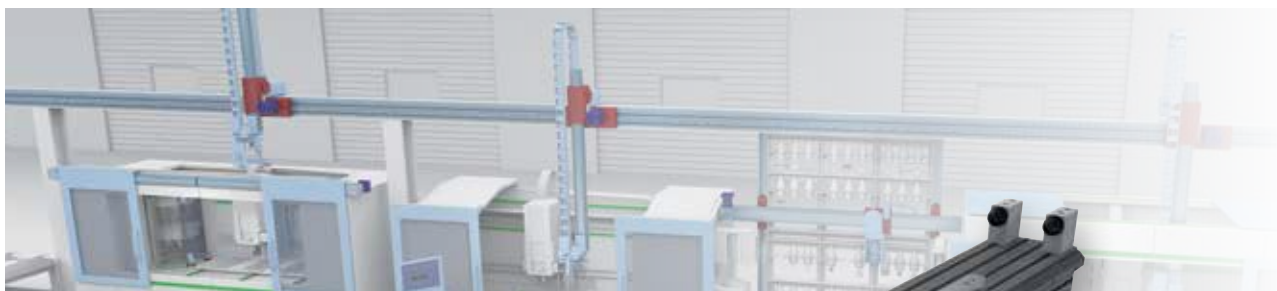

Suitable for very long strokes thanks to rack and pinion driving system.



Multiple independent carriages.



Available with recirculating ball guides or prismatic roller bearings.



High load capacities till 4.000 Kg.



Optimal reliability in dirty environments and high working cycles.



Wide range of aluminum profile sizes up to 360 mm.

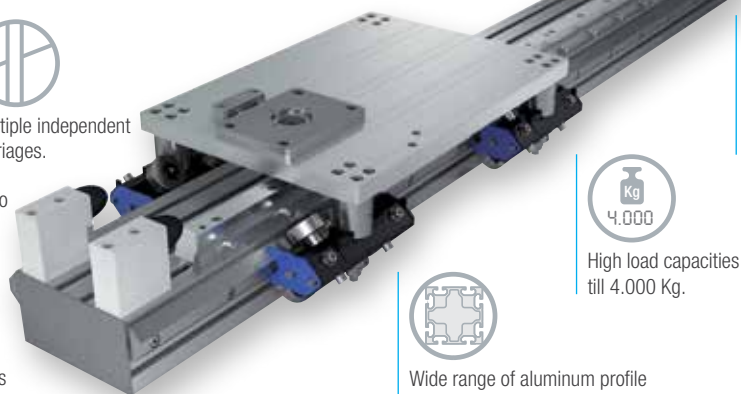

Speedy Rail A

Self-supporting and self-aligning extruded aluminum linear guides. They can be driven by belt or rack and pinion.



Optimal reliability in dirty environments.



Life time up to 80.000 Km.



High dynamics:
 $V=15\text{m/s}$, $A=10\text{m/s}^2$.



Self-supporting for greatest design freedom.

















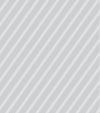





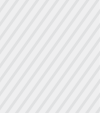
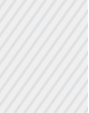

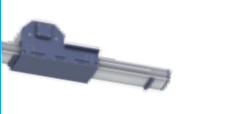

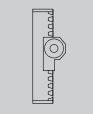
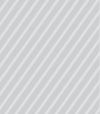



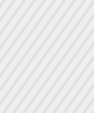

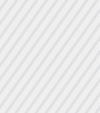
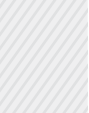





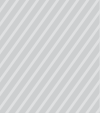
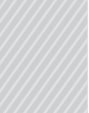



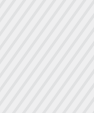

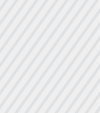
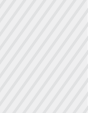
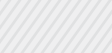
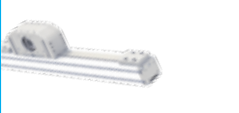



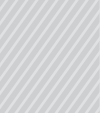

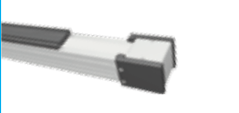

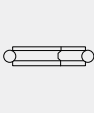

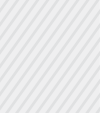
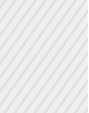
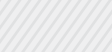

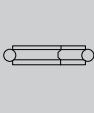

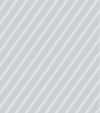



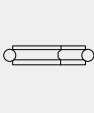

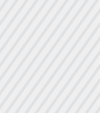
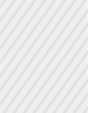









Absence of lubrication.

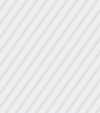
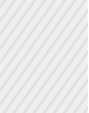

Use as a linear guide or actuator.

Technical features overview

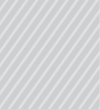

Reference		Linear motion system		Driving			Anticorrosion	Protection
Product Family	Product	Balls	Rollers	Toothed belt	Ball screw	Rack and pinion		
Plus System		ELM						 Protected
		ROBOT						 Protected
		SC						 Semi-protected
Clean Room System		ONE						 Protected with suction
Smart System		E-SMART						 Semi-protected
		R-SMART						 Semi-protected
		S-SMART						 Semi-protected
Eco System		ECO						 Semi-protected
Uniline System		A/C/E/ED/H						 Semi-protected
Modline		MCR MCH						 Semi-protected
		TCR TCS						 Semi-protected
		ZCR ZCH						 Semi-protected
		ZMCH						 Semi-protected

Reported data must be verified according to the application.





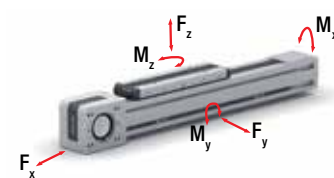





















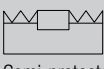





* Longer stroke is available for jointed version

Size	Max. load capacity per carriage [N]			Max. static moment per carriage [Nm]			Max. speed [m/s]	Max. acceleration [m/s ²]	Repeatability accuracy [mm]	Max stroke (per system) [mm]
	F _x	F _y	F _z	M _x	M _y	M _z				
50-65-80-110	4980	129400	129400	1392	11646	11646	5	50	± 0,05	6130*
100-130-160-220	9545	258800	258800	22257	28986	28986	5	50	± 0,05	6100*
65-130-160	6682	153600	153600	13555	31104	31104	5	50	± 0,05	2500
50-65-80-110	4980	104800	104800	1126	10532	10532	5	50	± 0,05	6000*
30-50-80-100	4980	130860	130860	1500	12039	12039	4	50	± 0,05	6145*
120-160-220	9960	258800	258800	21998	28468	28468	4	50	± 0,05	6050*
50-65-80	2523	51260	51260	520	3742	3742	4	50	± 0,05	2000
60-80-100	4565	76800	76800	722	7603	7603	5	50	± 0,05	6000*
40-55-75	19360	11000	17400	800,4	24917	18788	7	15	± 0,05	5700*
65-80-105	3984	51260	51260	520	5536	5536	5	50	± 0,1	10100*
140-170 200-220-230 280- 360	9960	266400	266400	42624	61272	61272	5	50	± 0,1	11480
60-90-100 170-220	7470	174480	174480	12388	35681	35681	4	25	± 0,1	2500
105	4980	61120	61120	3591	10390	10390	3	25	± 0,1	2100



Technical features overview



Reference		Linear motion system		Driving			Anticorrosion	Protection
Product Family	Product	Balls	Rollers	Toothed belt	Ball screw	Rack and pinion		
Precision System		TH						 Semi-protected
		TT						 Semi-protected
		TV						 Semi-protected
		TVS						 Semi-protected
Tecline		PAR PAS						
Speedy Rail A		SAB						
		ZSY						
		SAR						

Reported data must be verified according to the application.
 * Longer stroke is available for jointed version

Size	Max. load capacity per carriage [N]			Max. static moment per carriage [Nm]			Max. speed [m/s]	Max. acceleration [m/s ²]	Repeatability accuracy [mm]	Max stroke (per system) [mm]
	F _x	F _y	F _z	M _x	M _y	M _z				
70-90-110-145	32600	153600	153600	6682	5053	5053	2		± 0,005	1500
100-155-225-310	30500	230500	274500	30195	26625	22365	2,5		± 0,005	3000
60-80-110	11538	85000	85000	1080	2316	2316	2,5		± 0,01	3000
170-220	66300	258800	258800	19410	47360	47360	1	5	± 0,02	3500
118-140-170-200-220-230-280-360	10989	386400	386400	65688	150310	150310	4	10	± 0,05	10800*
60-120-180-250	4565	3620	3620	372	362	362	15	10	± 0,2	7150
180	4980	2300	2600	188	806	713	8	8	± 0,2	6640
120-180-250	3598	3620	3620	372	453	453	3	10	± 0,15	7150*

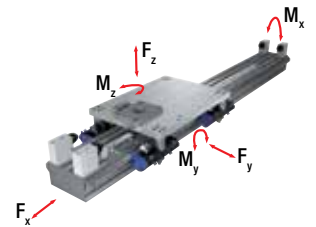

Actuator System Line

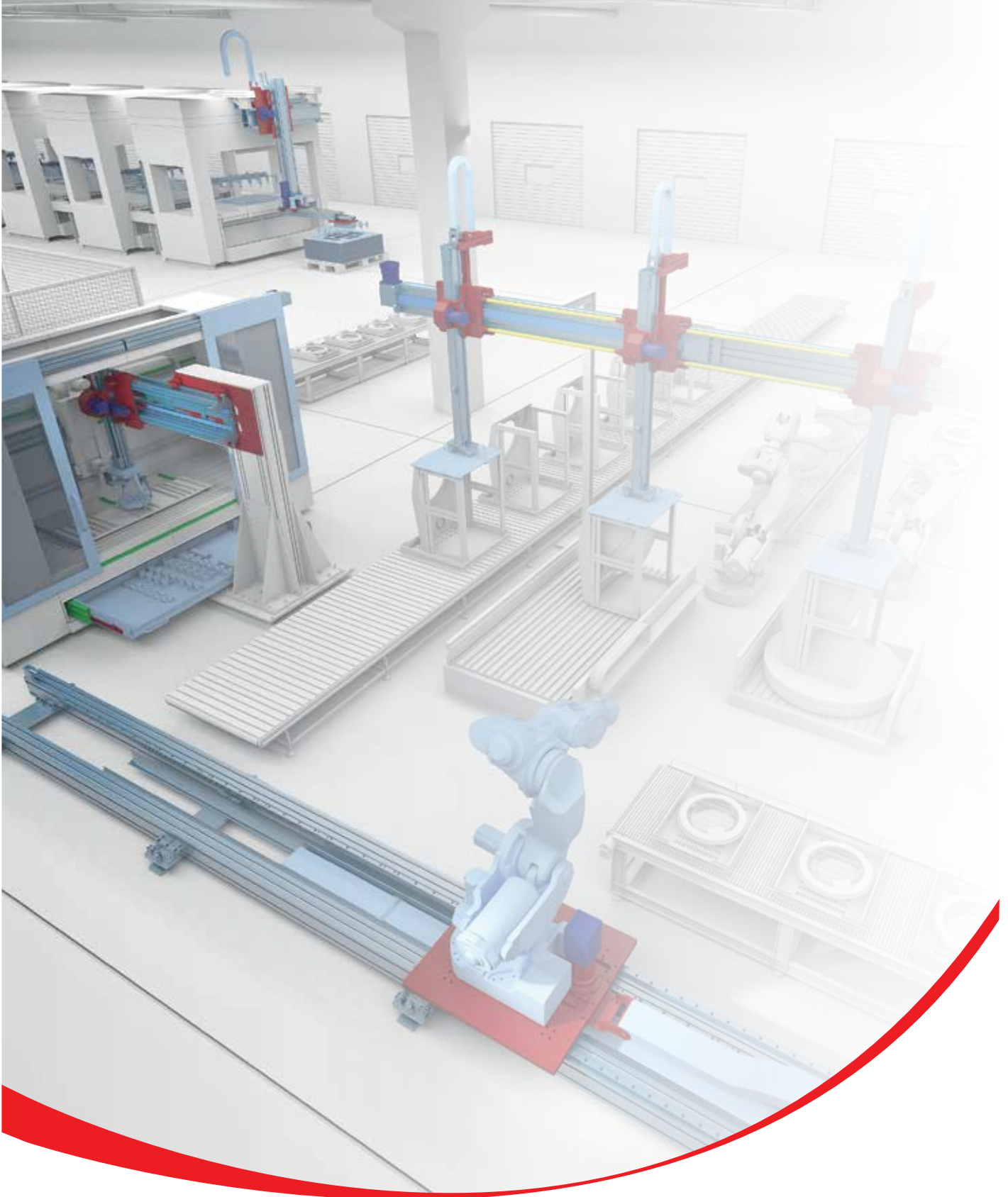

Seventh Axis

Increase a robot's range of motion. Available in 7 different sizes, Rollon Seventh Axis is easy to integrate and can move any type of robot weighing up to 2000 Kg.

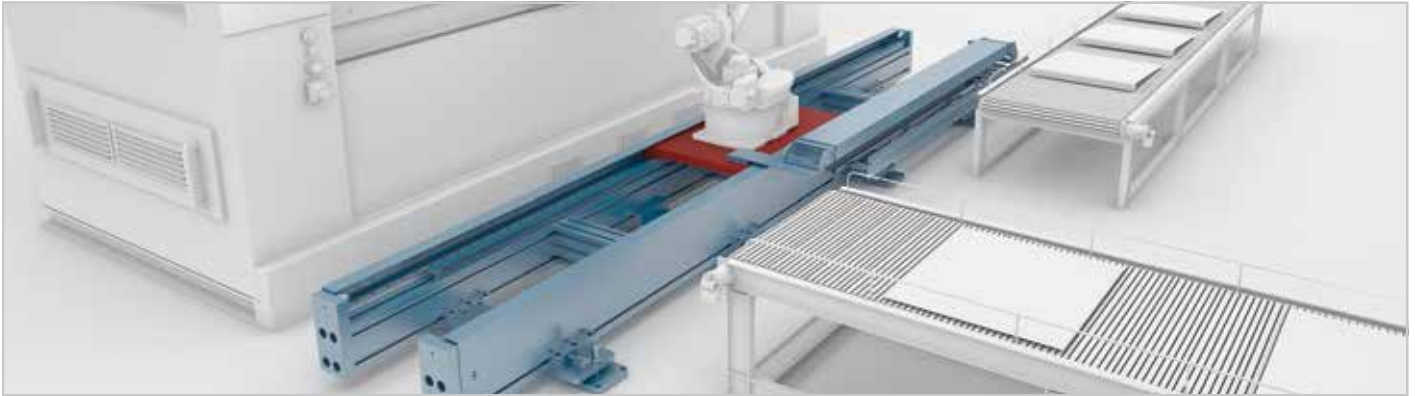

Protection for every work environment with three different options.



Easily integrated with any type of robot thanks to a complete range of 7 different sizes.

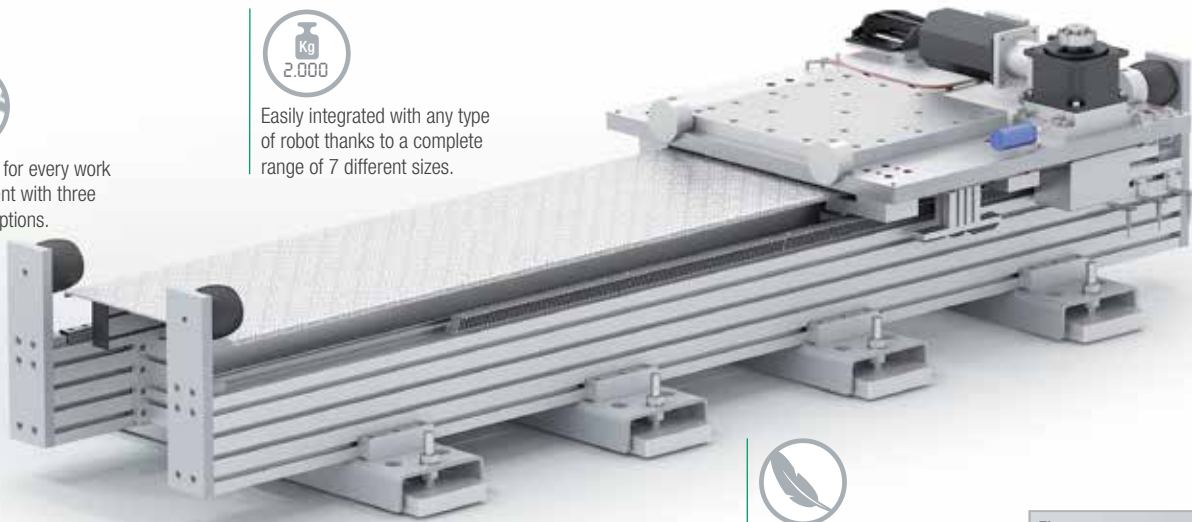

New technology with high rigidity extruded aluminum profiles and connecting crosspieces.



Potentially infinite strokes due to jointable versions with self-centering inserts.



Simplified mounting and alignment due to a system of steel crosspieces and feet with two different adjustment systems.

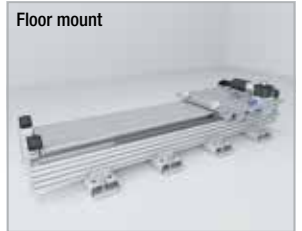

LOAD CAPACITY ACCORDING TO DYNAMICS

Reported data must be verified according to the application. For more information, please contact our technical department.

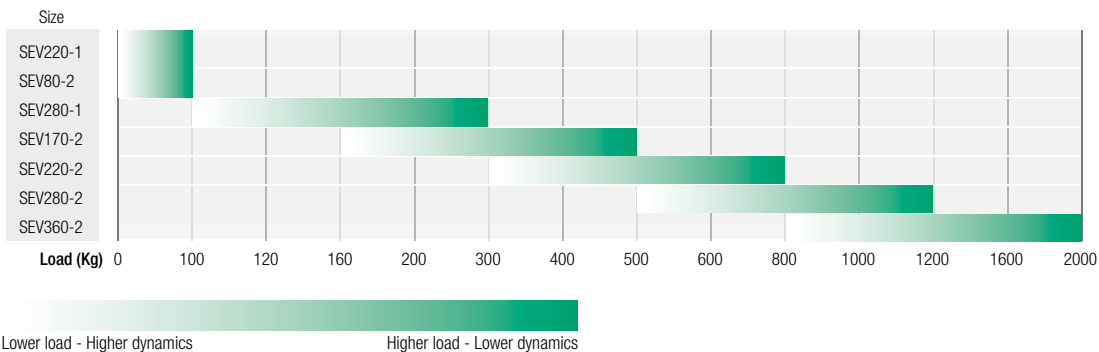

Seventh Axis

Technical Features



Reference		Linear guides		Drive		Anti-corrosion	Protection				Size	Number of profiles
Family	Product	Rollers	Balls	Rack	Belt		Sealing Strip	Simple	Partial	Total		
Seventh Axis	SEV220-1						√				220x100	1
	SEV80-2						√				80x80	2
	SEV280-1							√			170x280	1
	SEV170-2							√	√	√	170x120	2
	SEV220-2							√	√	√	220x120	2
	SEV280-2							√	√	√	280x170	2
	SEV360-2							√	√	√	360x200	2

The data shown must be verified on the basis of the application.

*1 Robot examples mentioned are approximate and refer to floor mounted version. For a correct choice and size of the robot please contact our technical department.

Maximum speed [m/s]	Maximum acceleration [m/s ²]	Repeatability [mm]	Maximum stroke [mm]	Robot examples*1			
				Brand	Model	Payload [Kg]	Weight [Kg]
2	4	+/-0.05	5600	ABB	IRB 120; IRB 140; IRB 1100; IRB 1200;	3-6	20.5-98
				COMAU	Racer-5-0.63; Racer 5-0.80; Racer-3-0.63;	3-5	30-32
				FANUC	LR Mate 200 iD	4-7	19.27
2	4	+/-0.05	5680	KAWASAKI	RS003N; RS005N; RS005L; RS007N; RS007L	3-7	20-37
				KUKA	Agilus Serie KR3; KR6; KR10	3-10	26-57
				MITSUBISHI	RV-2FR; RV-2FRL; RV-4FR; RV-4FRL;RV-7FR; RV-7FRL; RV-7FRLL	3-7	19-130
				NACHI	MZ07-01; MZ07L-01;MZ07P-01; MZ07LP-01;	7	30-32
				STÄUBLI	TX2-40; TX2-60; TX2-60L	2-4.5	29-53
				UNIVERSAL ROBOTS	UR3/3e; UR5/5e; UR10/10e; UR16e	3-16	11-34
				YASKAWA	GP7; GP8	7-8	32-34
2	4	+/-0.05	∞	COMAU	Racer 7-1.0; Racer-7-1.4; SIX-6-1.4	6-7	160-180
				FANUC	ARC Mate 100iC/12; M-10iA/10M; M-10iA/12; M-10iD 12	10-12	130-145
				KAWASAKI	RS010N; RS006L	6-10	150
				KUKA	KR6 – KR10 CYBERTECH nano; KR6 – KR8 CYBERTECH ARC nano	6-10	145-180
				MITSUBISHI	RV13FR(-L); RV20FR	13-20	120-130
				NACHI	NB04; NV06;	10	160-170
				STÄUBLI	TP80; TX2-90; TX2-90L; TX2-90XL	7-14	111-119
2	4	+/-0.05	∞	YASKAWA	MH12/-F; GP12	12	130-150
				ABB	IRB 1600; IRB 1660ID; IRB 2600-12/-20; IRB 2600ID-8/-15;	4-20	250-284
				FANUC	M-20iA; M-20iA/20M; ARC Mate 120C; M-20iB/25; M-20iB/25C; M-20iA/35M	20-25	210-250
				KAWASAKI	RS020N; RS010L	10-20	230
				KUKA	KR CYBERTECH / KR CYBERTECH arc	8-22	250-270
				NACHI	MC10L; MC20; MR20-02; MR20L-01; NB04L; NV06L	10-20	220-280
				STÄUBLI	RX160; RX160HD; RX160L;	14-20	248-250
2	4	+/-0.05	∞	YASKAWA	GP25; GP25-12; HP20F/-RD 2	12-25	250-268
				ABB	IRB 2400; IRB 4600; IRB 6620LX;	10-150	380-610
				COMAU	NS-12-1.85; NS-16-1.65; NJ-16-3.1; NJ-40-2.5; NJ-60-2.2	12-60	333-680
				FANUC	M-710 all types	12-70	410-570
				KAWASAKI	RS030N; RS050N; RS080N, RS15X	30-80	555
				NACHI	MC35-01; MC50-01; MC70-01	35-70	640
				STÄUBLI	RX160; RX160HD; RX160L;	14-20	248-250
2	2	+/-0.05	∞	ABB	IRB460	110	925
				FANUC	M-710 all types	12-70	410-570
				KUKA	KR 30 and KR 60 - all types	16-60	600-700
				STÄUBLI	TX200L	80	1000
2	2	+/-0.05	∞	ABB	IRB460, IRB6620	110-150	900-925
				COMAU	NJ130 2.6	100-270	1090-1470
				FANUC	R2000 all types; M900ib/360; R2000ic/210L; R2000ic/270F	165-360	1090-1540
				KUKA	KR 120, 150, 180, 210, 240, 270, 300	120-300	677-1154
				STÄUBLI	TX200, TX200L	80	1000

Actuator System Line

Multi-Axes Pick and Place

Multi-axes system for automated feeding of production and assembly lines.



Ready to use solution with high reliability due to 40 years experience.



Short belt technology (patent) system allow very long Y axis.



Both rack and pinion and belt driving systems allow to move independent groups of carriages.



Z axis with pneumatic counterbalance allows energy saving and smaller motors.



Energy chains, safety systems and other accessories is available.



Integrated lubrication system allows long life and low maintenance.



Light and stiff aluminum beams allow high dynamics and fast duty cycles.

LOAD CAPACITY ACCORDING TO DYNAMICS

Reported data must be verified according to the application. For more information, please contact our technical department.

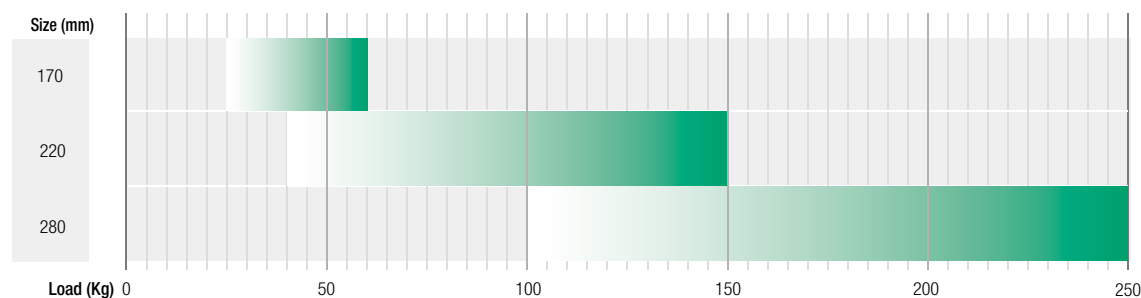

Lower load - Higher dynamics

Higher load - Lower dynamics

Multi Gantry

Gantry solutions designed for each specific application in different industrial sectors.

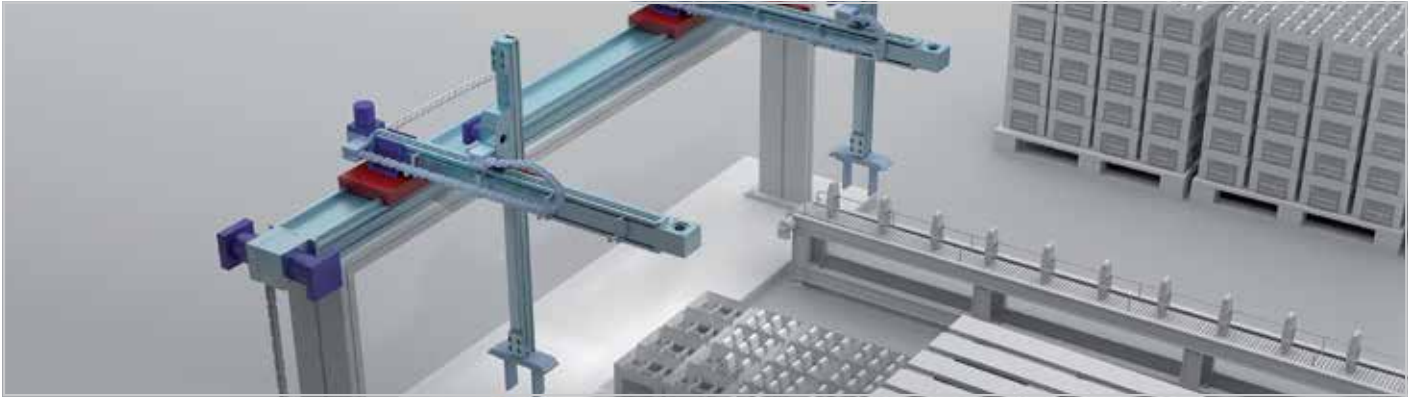

Wide range of stiff aluminum beams allow to have a long span or to use less columns for the structure.



Light and stiff aluminum beams allow high dynamics and fast duty cycles.



Recirculating balls guides or prismatic roller guides allow to match different needs in terms of dirty environments, precision, dynamics and smoothness.



Self-alignment technologies allow cost effective mounting for parallel axes in very long systems.



Dedicated omega technology for Z axis allow space saving and higher dynamics.



Belt, ball screw and rack and pinion driving systems allow to achieve the right precision and dynamics for any application.



Integrated lubrication system allows long life and low maintenance.



LOAD CAPACITY ACCORDING TO DYNAMICS

Reported data must be verified according to the application. For more information, please contact our technical department.

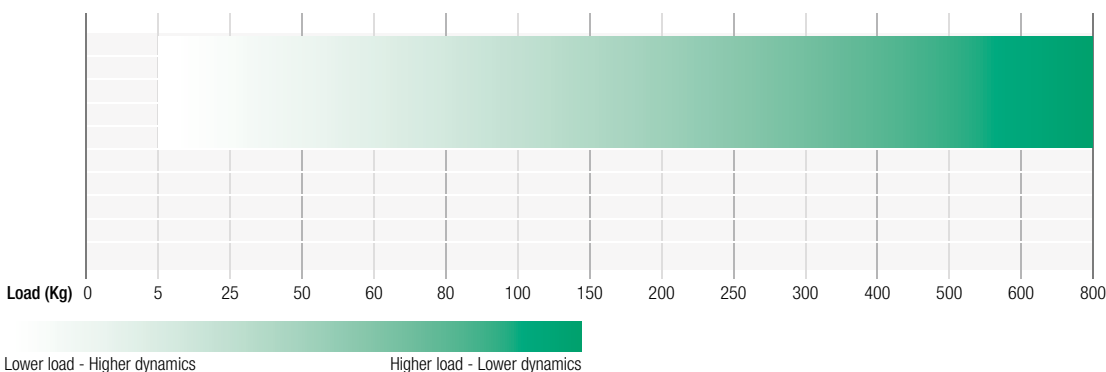

Actuator System Line

Transfer Press

Dedicated solution for transfer press.

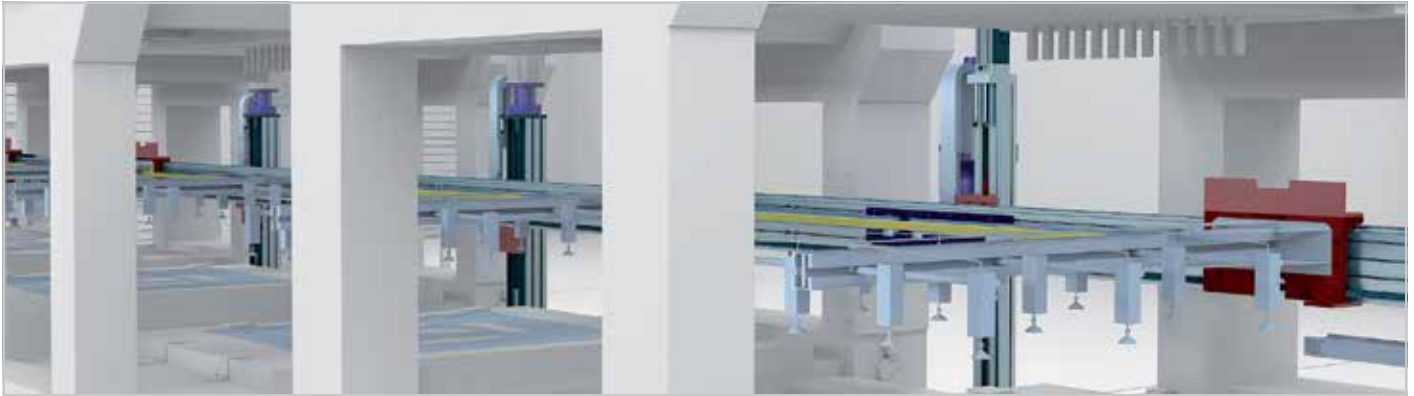

Ready to use solution with high reliability due to 40 years experience.



Short belt technology (patent) system allow very long Y axis.



Integrated lubrication system allows long life and low maintenance.



Light and stiff aluminum beams allow high dynamics and fast duty cycles.

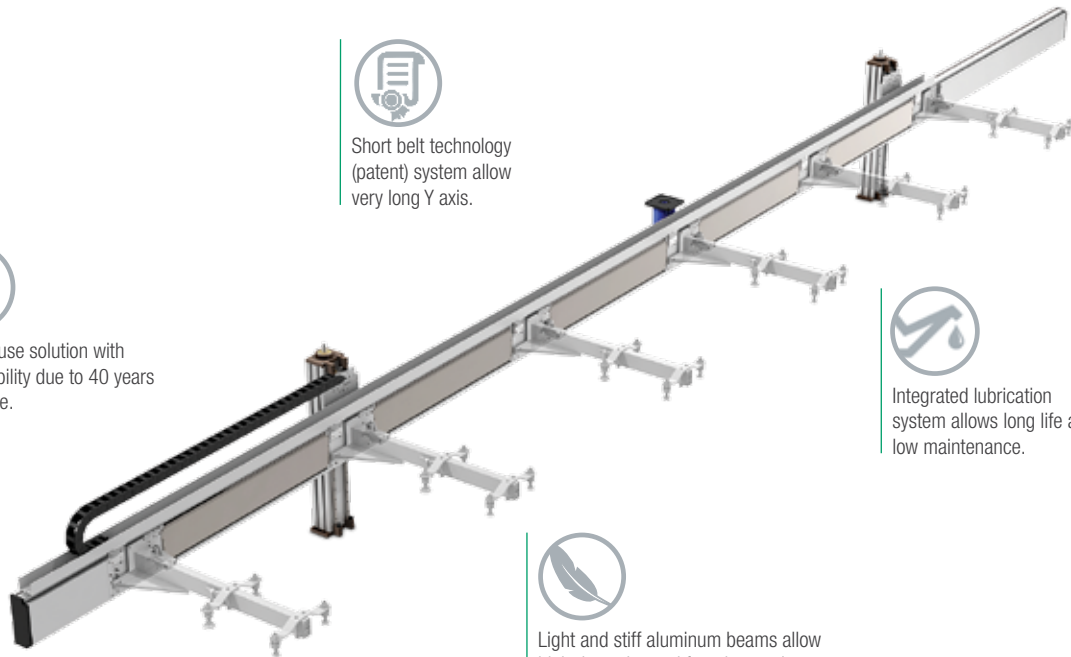

LOAD CAPACITY ACCORDING TO DYNAMICS

Reported data must be verified according to the application. For more information, please contact our technical department.

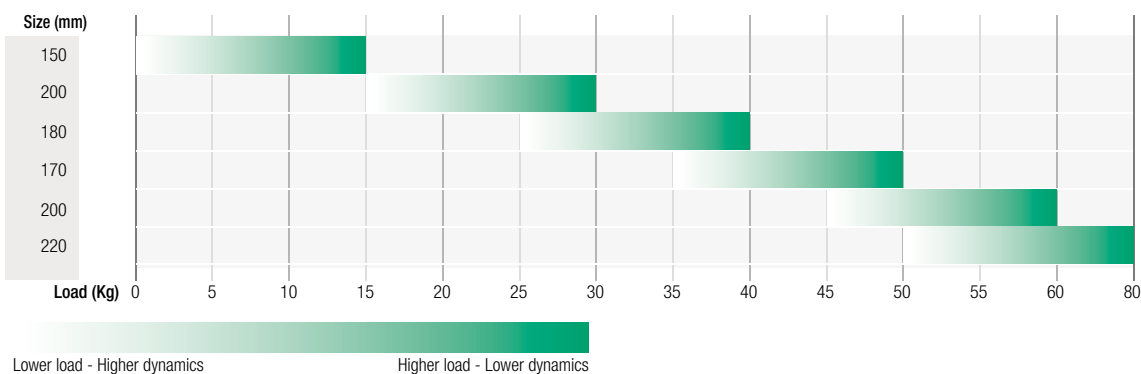

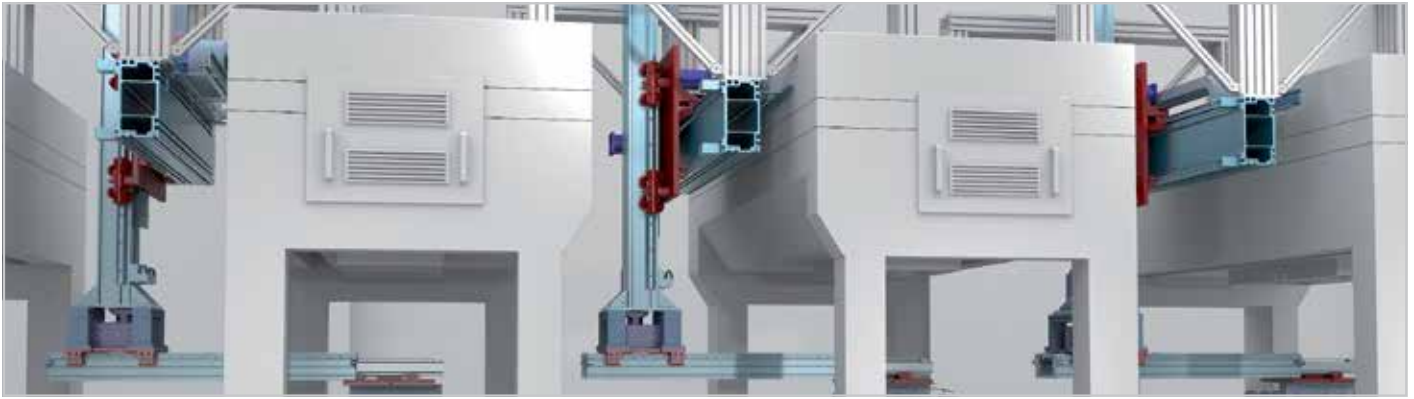

Telescopic Actuator - Horizontal

Double stroke telescopic actuator for metal sheets handling.





- 

High dynamics thank to the multiplication of speed of each level.
- 

Compact and space saving thanks to 3 or 4 stages solutions.
- 

Connectable with vertical linear axes.
- 

Synchronized belt system allows an optimized extension.
- 

Light and stiff aluminum beams allow higher dynamics.
- 

Optimization of the process thanks to double stroke.

LOAD CAPACITY ACCORDING TO DYNAMICS

Reported data must be verified according to the application. For more information, please contact our technical department.

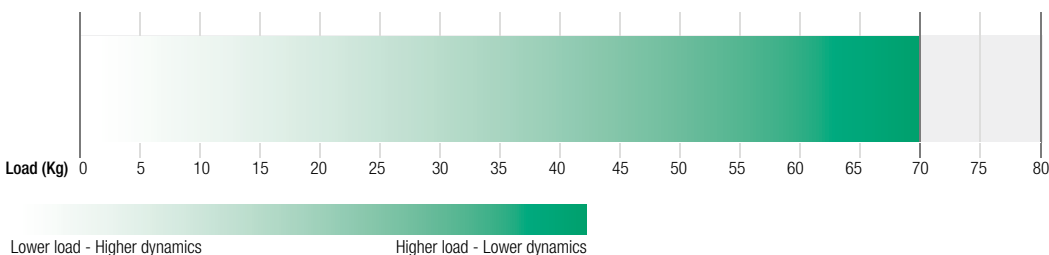

Actuator System Line

Telescopic Actuator - Wall Mounted

Double stroke telescopic actuator with vertical axis for pick and place in limited spaces.



Compact and space saving thanks to 3 or 4 stages solutions.



High dynamics thank to the multiplication of speed of each level.



Synchronized belt system allows an optimized extension.



Vertical linear axes can be mounted on the end carriage.



Optimization of the process thanks to double stroke.



Light and stiff aluminum beams allow higher dynamics.



Wall mounted configuration allows higher stiffness for heavy loads.

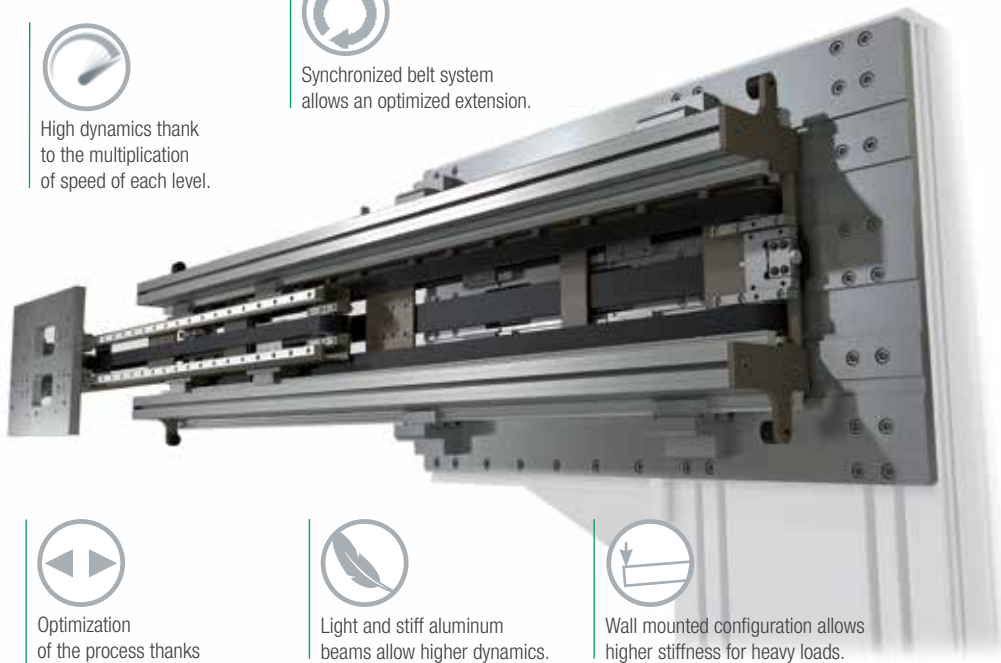

LOAD CAPACITY ACCORDING TO DYNAMICS

Reported data must be verified according to the application. For more information, please contact our technical department.

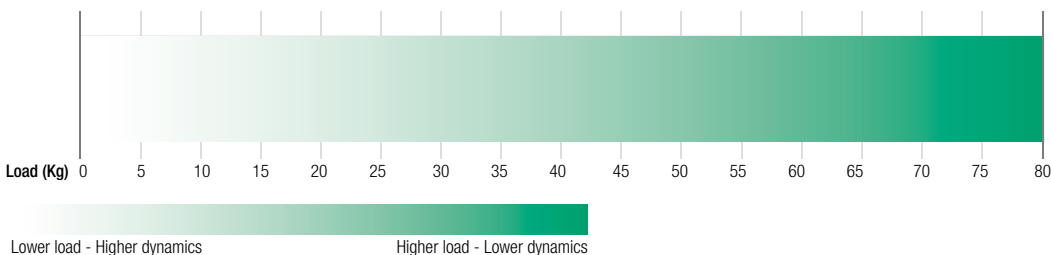

Telescopic Actuator - Z

Vertical telescopic actuator for pick and place in limited ceiling height.

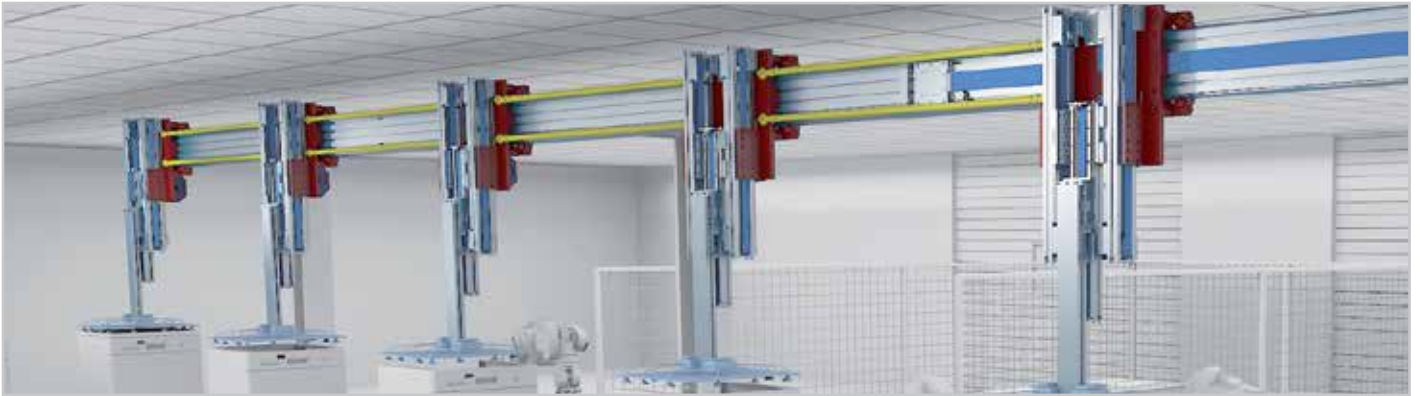

Compact and space saving thanks to 3 or 4 stages solutions.



Synchronized belt system allows an optimized extension.



High dynamics thank to the multiplication of speed of each level.



It can be part of multiple axes configurations.



Light and stiff aluminum beams allow higher dynamics.



LOAD CAPACITY ACCORDING TO DYNAMICS

Reported data must be verified according to the application. For more information, please contact our technical department.

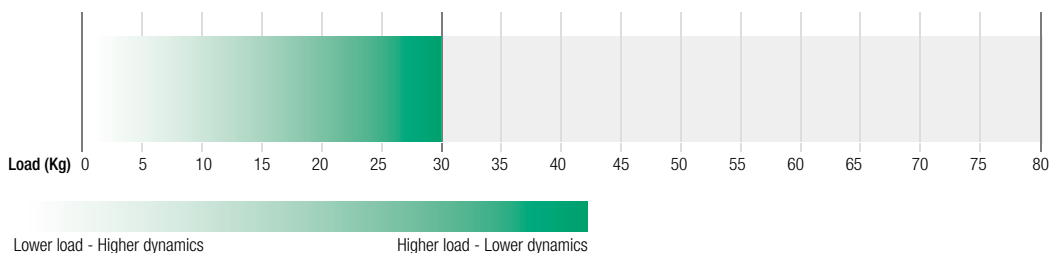



Follow us:



● Rollon Branches & Rep. Offices
● Distributors

EUROPE

ROLLON S.p.A. - ITALY (Headquarters)

Via Trieste 26
I-20871 Vimercate (MB)
Phone: (+39) 039 62 59 1
www.rollon.com - infocom@rollon.com

ROLLON GmbH - GERMANY

Bonner Strasse 317-319
D-40589 Düsseldorf
Phone: (+49) 211 95 747 0
www.rollon.de - info@rollon.de

ROLLON S.A.R.L. - FRANCE

Les Jardins d'Eole, 2 allée des Séquoias
F-69760 Limonest
Phone: (+33) (0) 4 74 71 93 30
www.rollon.fr - infocom@rollon.fr

ROLLON B.V. - NETHERLANDS

Ringbaan Zuid 8
6905 DB Zevenaar
Phone: (+31) 316 581 999
www.rollon.nl - info@rollon.nl

ROLLON S.p.A. - RUSSIA (Rep. Office)

117105, Moscow, Varshavskoye
shosse 17, building 1
Phone: +7 (495) 508-10-70
www.rollon.ru - info@rollon.ru

ROLLON Ltd - UK (Rep. Office)

The Works 6 West Street Olney
Buckinghamshire, United Kingdom, MK46 5 HR
Phone: +44 (0) 1234964024
www.rollon.uk.com - info@rollon.uk.com

AMERICA

ROLLON Corporation - USA

101 Bilby Road. Suite B
Hackettstown, NJ 07840
Phone: (+1) 973 300 5492
www.rolloncorp.com - info@rolloncorp.com

ROLLON - SOUTH AMERICA (Rep. Office)

R. Joaquim Floriano, 397, 2o. andar
Itaim Bibi - 04534-011, São Paulo, BRASIL
Phone: +55 (11) 3198 3645
www.rollonbrasil.com.br - info@rollonbrasil.com

ASIA

ROLLON Ltd - CHINA

No. 1155 Pang Jin Road,
China, Suzhou, 215200
Phone: +86 0512 6392 1625
www.rollon.cn.com - info@rollon.cn.com

ROLLON India Pvt. Ltd. - INDIA

1st floor, Regus Gem Business Centre, 26/1
Hosur Road, Bommanahalli, Bangalore 560068
Phone: (+91) 80 67027066
www.rollonindia.in - info@rollonindia.in

ROLLON - JAPAN

3F Shiodome Building, 1-2-20 Kaigan, Minato-ku,
Tokyo 105-0022 Japan
Phone +81 3 6721 8487
www.rollon.jp - info@rollon.jp

Consult the other ranges of products



Distributor

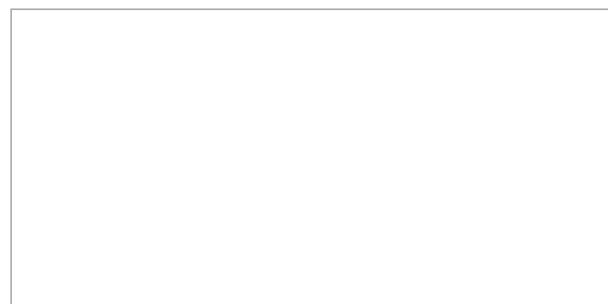

All addresses of our global sales partners can also be found at www.rollon.com

The content of this document and its use are subject to the general terms of sale of ROLLON available on the web site www.rollon.com
Changes and errors expected. The text and images may be used only with our permission.