



QUICK SELECTION / Selezione veloce

input speed (n_1) = 1400 min⁻¹

Output Speed n_2 [min ⁻¹]	Ratio i	Motor power P_{1M} [kW]	Output torque M_{2M} [Nm]	Service factor f.s.	Nominal power P_{1R} [kW]	Nominal torque M_{2R} [Nm]	Available B5 motor flanges				Available B14 motor flanges			Dynamic efficiency RD	Tooth Module M_n [mm]	Ratios code
							B	C	D	E	Q	R	T			
							63	71	80	90	71	80	90			
16.8	83.2	1.5	562	1.1	1.6	600					C			69	3.5	01
13.9	100.5	1.5	651	0.8	1.2	540					C			68	2.9	02
10.6	132	1.1	574	0.9	1.0	500					C			64	2.2	03
8.0	176	0.75	594	1.2	0.92	730	B				C			74	4.7	04
6.7	208	0.75	670	0.9	0.67	600	B				C			72	4.0	05
5.7	245	0.55	570	1.1	0.58	600	B				C			69	3.5	06
4.7	296	0.55	611	0.9	0.49	540	B				C			68	2.9	07
4.2	334	0.55	689	0.9	0.48	600	B				C			69	3.5	08
3.5	403	0.37	519	1.0	0.39	540	B				C			68	2.9	09
2.6	529	0.25	424	1.2	0.29	500	B				C			64	2.2	10
2.2	624	0.25	479	1.0	0.25	480	B				C			59	1.9	11

Motor Flanges Available
Flange Motore Disponibili

B) Supplied with Reduction Bushing
Fornito con Bussola di Riduzione

B) Available on Request without reduction bushing
Disponibile a Richiesta senza Bussola di Riduzione

C) Motor Flange Holes Position
Posizione Fori Flangia Motore

EN Unit P1Q is supplied without lubricant and equipped with a breather, level and drain plugs. User can add mineral oil keeping existing plugs. Should the user wish to fill it with synthetic oil, it is recommended to replace the existing plugs with a closed plug. Primary reduction unit is supplied with closed plugs and lubricated for life with synthetic oil. See table 1 for lubrication and recommended quantity. In table 2 please see possible radial loads and axial loads on the gearbox. For complete documentation please visit our web site.

I Il riduttore tipo P1Q è fornito privo di lubrificazione con tappi di sfiato, livello e scarico olio. L'utente può immettere olio minerale mantenendo i tappi esistenti. Se immetterà olio sintetico, dovrà sostituire i tappi esistenti con altri tipo chiuso. La precoppia è fornita con tappi chiusi e lubrificata a vita con olio sintetico. Tab.1 per oli e quantità consigliati. Tab.2 carichi radiali e assiali applicabili al riduttore. Per la documentazione completa consulta il nostro sito.

D Das Getriebe der Baugröße P1Q wird ohne Schmiermittel geliefert. Es ist jedoch mit Einfüllschraube, Überdruckventil und Ablassschraube ausgerüstet. Das benötigte mineralische Öl kann über die Einfüllschraube eingefüllt werden. Sollte synthetisches Öl bevorzugt werden, so ist sind das eingebaute Überdruckventil durch eine geschlossenen Schraube zu ersetzen. Die Stirnradvorstufe ist Lebensdauer geschmiert und wird mit synthetischem Öl geliefert. Die Stirnradvorstufe ist komplett geschlossen ohne Füllschrauben. In Tabelle 1 ist die Schmiermenge und das empfohlene Schmiermittel angegeben. In Tabelle 2 sind die zulässigen Radial- und Axialbelastungen des Getriebes aufgeführt. Die komplette Dokumentation, Wartungs- und Inbetriebnahmeanleitungen finden Sie unter.

E El reductor tamaño P1Q se suministra sin lubricante, provisto de tapones de respiración, nivel y descarga de aceite. El usuario puede utilizar aceite mineral, manteniendo los tapones existentes. Si prefiere utilizar aceite sintético deberá sustituir los tapones existentes por tapones ciegos. La prerreducción se suministra con tapones ciegos, lubricado de por vida con aceite sintético. Ver tabla 1, para cantidades y aceites recomendados. En la tabla 2, se encuentran las cargas radiales y axiales admitidas por el reductor. Para documentación completa, consultar nuestra Web.

2.0/0.14LT	1.5/0.14 LT	1.5/0.14 LT	2.0/0.14 LT	2.0/0.14 LT	2.0/0.14 LT
AGIP	BP	SHELL	KLUBER	MOBIL	
Telium VSF 320	Energol SGXP220	Tivela Oil WB	Syntheso D220 EP	Glygoyl 30	

tab. 1

RADIAL AND AXIAL LOADS

Output shaft
Albero di uscita

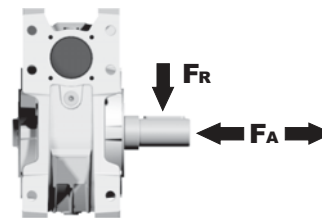

n_2 [min ⁻¹]	FA [N]	FR [N]
75	800	4000
50	920	4600
25	1200	6000
15-6	1400	7000

Input shaft
albero in entrata

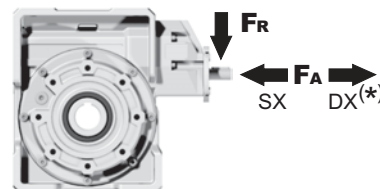

n_1 [min ⁻¹]	FA [N]	FR [N]
1400	150	760

***Strong axial loads in the DX direction are not allowed.**
Non sono consentiti forti carichi assiali con direzione DX

tab. 2

SELECT THIS TYPE AND THIS SPECIFIC SIZE ON THE WEB PAGES TO GET COMPLETE TECHNICAL DATA.
Selezionare tipo e gandezza specifica nel sito web per la documentazione completa.

PP1Q**FB**... Basic wormbox
Riduttore base

Gearbox weight
peso riduttore **37.3 kg**

M. flanges	Kit code	øF	A
63B5	K063.4.041	140	214.7
71B5	K063.4.042	160	212.7
80/90B5	K063.4.043	200	214.7
71B14	K063.4.047	105	212.7
80B14	K063.4.046	120	213.7
90B14	K063.4.041	140	214.7

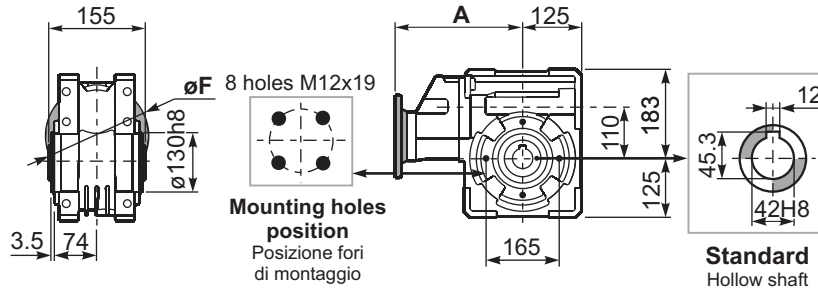

PP1Q**FC**... Output flange
Flangia uscita

PP1Q**F1**... Output flange
Flangia uscita

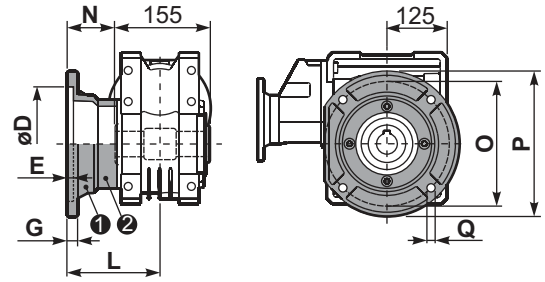
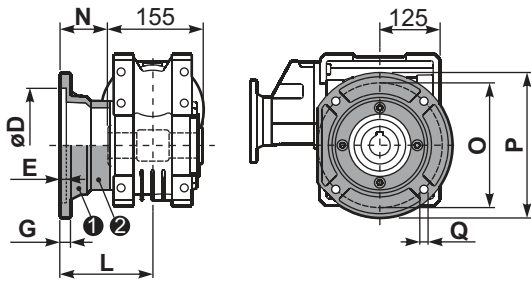

type B	øD	E	G	L	N	O	P	Q	kit code
FC	170 ^{+0.083} / _{+0.043}	11	16.5	131.5	54	230	270	13	1 K110.9.010 2 -
FL	170 ^{+0.083} / _{+0.043}	11	16.5	179.5	102	230	270	13	1 K110.9.011 2 -

type S	øD	E	G	L	N	O	P	Q	kit code
F1	180 ^{+0.040} / ₀	5	18	150	72.5	215	250	15	1 KS110.9.014 2 -
F2	170 ^{+0.083} / _{+0.043}	9.5	15	178	100.5	230	270	13	1 KS110.9.012 2 -
F3	180 ^{+0.040} / ₀	5	18	130	52.5	215	250	15	1 KS110.9.013 2 -

PP1Q**FB**... Feet
Piedini

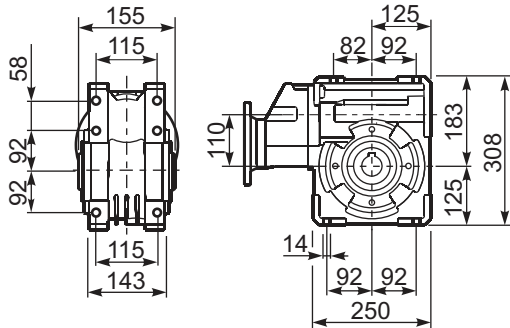

PP1Q**BR**... Reaction arm
Braccio di reazione

kit cod. K110.9.027

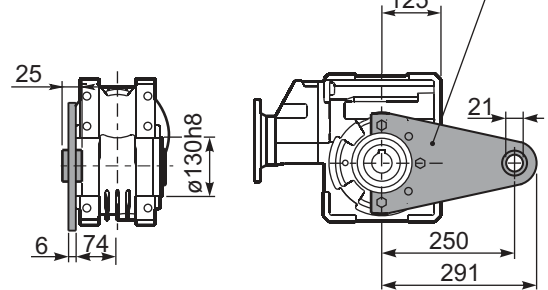

RP1Q**FB**... Input shaft
Albero in entrata

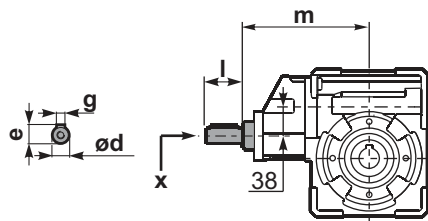

PP1Q.....**S**... Single Shaft
Albero lento semplice

PP1Q.....**D**... Double Shaft
Albero lento bisp.

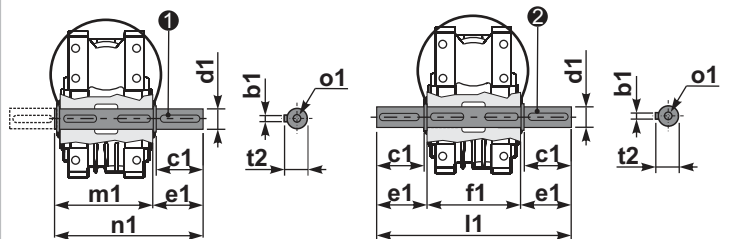

1 kit cod. K110.5.028 type B 2 kit cod. K110.5.029 type B

	ød	e	g	l	m	x	
type B	19 j5	21.5	6	35	205	M6x16	C40.5.062
type S	-	-	-	-	-	-	-

	b1	c1	d1	e1	f1	l1	m1	n1	t2	o1
type B	12	75	42 ^{-0.005} / _{-0.020}	96.5	155	348	163.5	260	45	M12x32
type S	-	-	-	-	-	-	-	-	-	-