

Operating instructions

VarioShaker 540

with control box

Item number: VA-Art-00046



Read before assembly and commissioning!

www.variobotic.de

 EN

Operating instructions

All non-German versions of this document are translation of the original document!

machine no.: VA-Art-00046
project name: VarioShaker 540
year of construction: 2021
Revision: Rev-B 02/2021_en
Creator: Technische Dokumentation Wörtz | www.tedok-woertz.de
Copyright by: Variobotic GmbH

Declaration of incorporation

for the purpose of Machinery Directive 2006/42/EC, appendix II Part 1
Paragraph B

We:

Company

Variobotic GmbH

Dr.-Carl-Schwenk-Str. 24
89233 Neu-Ulm (Germany)

hereby declare that the machine:

Item number: VA-Art-00046

project name: VarioShaker 540

function: separation of components

year of construction: 2021

the basic requirements of Machine Directive 2006/42/EC are fulfilled. The following requirements according to appendix I of the directive are applied and complied with:

- General principle no. 1
- Article 1.1.2, 1.1.3, 1.1.5, 1.2.1, 1.2.3, 1.2.4, 1.2.5, 1.2.6, 1.3.2, 1.3.3, 1.3.4 and 1.5.1.

The protective targets of the directive 2014/30/EU on the electromagnetic tolerability are complied with in application of EN 61000-6-4:2007 +A1:2011; EN 61000-6-2:2005 +AC:2005; EN 61000-3-2:2014; EN 61000-3-3:2013.

The commissioning of the incomplete machine is prohibited until it has been installed in a machine and the entire machine corresponds to the regulations of the machine directive (2006/42/EC).

The technical documents specifically belonging to the machine were created according to appendix VII part B. The manufacturer is obligated to electronically transfer the special documents for the incomplete machine to individual federal sites with justified request.

Authorised person in terms of appendix II no. 1 A. No. 2; 2006/42/EC for compilation of technical documents:

Name: Company Variobotic GmbH; Technical documentation

Address: See address of the manufacturer

submitted by:

Neu-Ulm, _____ : _____
Peter Klement (managing director)

Unsigned copy

Table of contents

TABLE OF CONTENTS	7
1. GENERAL NOTES	11
1.1 About this operating instructions	11
1.1.1 Responsibilities.....	11
1.1.2 This operating instructions.....	11
1.1.3 Language.....	11
1.1.4 Storing this document	11
1.1.5 Copyright	11
1.2 Used symbols and keywords.....	12
1.2.1 Notes in this document	12
1.2.2 Action-related keywords	12
1.2.3 Appearance of the warnings.....	13
1.2.4 Explanation of used symbols.....	14
2. SAFETY	15
2.1 Intended use	15
2.1.1 Environment for proper use	15
2.1.2 Not intended use.....	15
2.1.3 Predictable misuse	15
2.1.4 Warranty and liability	16
2.1.5 Introduction and instruction of people	16
2.2 Personnel qualification	17
2.2.1 Basic requirements	17
2.2.2 Operator.....	17
2.2.3 Commissioning / maintenance staff.....	17
2.2.4 Electrician	17
2.2.5 Unauthorized persons	17
2.3 Obligations of the user.....	18
2.4 Personnel obligations	18
2.5 Safety while working on electrical equipment.....	19
2.5.1 The five safety rules	19
2.6 Fire fighting	20
2.7 Safety during normal operation	20
3. STRUCTURE AND FUNCTION	21
3.1 Structure	21

3.2	Functional description.....	21
4.	TRANSPORTATION, INSTALLATION AND CONNECTION	23
4.1	Set-up and fasten.....	23
4.1.1	Dimensions of the system base plate	24
4.1.2	Assembly on system base plate	24
4.1.3	Drill image for assembly.....	25
4.1.4	Assembly alternatives	25
4.2	Changing the vibration plate	26
5.	ELECTRICAL CONNECTION.....	27
5.1	Connection of the control box	27
5.1.1	Connection strip form the control box	27
5.2	Connection to the VarioShaker	29
6.	OPERATION AND USAGE.....	31
6.1	VarioShaker user interface	31
6.2	Resetting network settings.....	33
6.3	Preset and file management (RED).....	34
6.3.1	PRESET CLIPS	34
6.3.2	MY CLIPS	36
6.3.3	MY SEQUENCES	37
6.4	CLIP EDITOR (green).....	38
6.4.1	Basics clip EDITOR	38
6.4.2	Function buttons	39
6.4.3	Other functions.....	41
6.4.4	Introduction to the creation of CLIPS.....	42
6.5	SEQUENCE EDITOR (blue).....	43
6.5.1	Basics of the SEQUENCE EDITOR	43
6.5.2	SLOT assignment	45
6.6	Settings (Yellow)	46
6.6.1	Presettings (Preferences)	46
6.6.2	Network configuration (Network)	47
6.6.3	Data backup and restoration (backup and load).....	48
6.6.4	Input and output check (digital IO check)	48
6.6.5	Update and Version (Update and Version).....	49
6.6.6	Contact.....	52
6.7	Tips for operation	53

Table of contents

7.	MAINTENANCE AND REPAIR	55
7.1	General measures for service and maintenance.....	56
8.	SERVICE AND MAINTENANCE	57
8.1	Contact data	57
8.1.1	In the event of disruptions and technical problems:	57
8.2	Spare and wear parts	58
9.	DISASSEMBLY AND DISPOSAL	59
9.1	Disassembly for disposal.....	59
9.1.1	Notes on disposal	59
10.	TECHNICAL DATA.....	61
10.1	Dimensions	61
10.2	Climatic and environmental requirements	61
10.3	Electrical and software-technical requirements.....	62
10.4	Maximum component size and component weight	62
11.	ANNEX.....	63
11.1	Switch and connection plan control box	63
11.2	For your notes.....	64
12.	DIRECTORIES.....	68
12.1	List of figures	68
12.2	List of tables.....	68

1. General notes

1.1 About this operating instructions

Please carefully read through this operating instructions before using this machine. Through this, you can avoid errors during operation of the machine and learn how to optimally use all characteristics and functions of the machine.

1.1.1 Responsibilities

Company

Variobotic GmbH

Dr.-Carl-Schwenk-Str. 24
89233 Neu-Ulm (Germany)

Telephone: +49 731 8507 2200

E-mail: info@variobotic.de

Web: www.variobotic.de

1.1.2 This operating instructions

This operating instructions belongs to:

type: VarioShaker 540

function: separation of components

Item number: VA-Art-00046

year of construction: 2021

1.1.3 Language

This document was drafted in German. All non-German language versions of this document are translations of the original document.

1.1.4 Storing this document

The operator is obliged to store this document properly and to keep it accessible at the place of use of the machine.

1.1.5 Copyright

The copyright of this document remains with the company Variobotic GmbH. This document must not be reproduced, distributed or used for competition purposes, neither in whole nor in part, nor disclosed to third parties without authorisation. Violations of this may result in legal consequences.

1.2 Used symbols and keywords

Notes in this document have the following appearance.

1.2.1 Notes in this document

There are two different types of notes:



A **tip / note** from the manufacturer is identified with this symbol



Observe additional documentation!

A reference to additional documentation outside of these operating instructions is identified with this symbol.

1.2.2 Action-related keywords

The following keywords apply to different hazard levels:



Describes a very dangerous situation that will lead to death or permanent injury if the safety note is ignored.



Describes a dangerous situation that may lead to death or permanent injury if the safety note is ignored.



Describes a dangerous situation that may lead to treatable injuries if the safety note is ignored.



Warning note for property damage, which may result in production failures or machine damage if the safety notes is not followed.

1.2.3 Appearance of the warnings

The warnings in this document as well as those attached to the machine must be strictly and completely obeyed. In the event of non-compliance, the manufacturer does not take over any liability for any personal and property damage that arises.

Installed safety symbols may not be removed, pasted over, painted over or in any other way impaired in their recognition.



Danger!

Type and source of hazard

Consequences upon the occurrence of a hazard

Actions against the hazard



Warning!

Type and source of hazard

Consequences upon the occurrence of a hazard

Actions against the hazard



Caution!

Type and source of hazard

Consequences upon the occurrence of a hazard

Actions against the hazard

Note!

Plant or machine damage

Consequences upon the occurrence of a hazard

Actions against the hazard

1.2.4 Explanation of used symbols

- Warning sign





	Hazardous area!	General hazard or hazard not defined through a picture
	Electric current or voltage!	Only open identified components after release of the supply line to the machine and only by an electrician. (for example, control cabinet) Installed directly at the hazardous area!
	Obstacles on the ground	Warning of tripping hazards through machine components assembled on the ground. Must be installed when setting up the machine at the hazardous area.
	Protective earthing	Connect the earthing cable to the identified site.
	Electromagnetic fields	Persons who wear pacemakers or other active medical implants may be in danger when exposed to EMF.

table 1.1: Explanation of used symbols

2. Safety

2.1 Intended use

The operating safety of the machine is only guaranteed with proper usage.

With the VarioShaker 540, you receive a component separator from the series VarioShaker. The component separator is used to separate small parts, conveyed and bulk materials by mechanical vibrations. Through targeted movements, components with different geometrics can be separated. The VarioShaker 540 is integrated as an incomplete machine in automated industrial plants and is controlled in automatic mode via a communication interface. In addition to a web-based configuration for simple operation, the VarioShaker 540 has an I/O-interface as well as a TCP/IP interface and can therefore be adapted to nearly any industrial grade robot. The VarioShaker 540 can be adapted to individual product ranges by means of exchangeable quick-change plates and enables cost-effective and flexible automation for small and medium-sized companies. With regard to the maximum permissible dimensions and weights of the conveyed goods to be used, please refer to the technical data given for the product. Proper use also includes following all notes from the operating instructions, as well as following all safety notes.

2.1.1 Environment for proper use

Industrial / commercial use; no private users

2.1.2 Not intended use

- not for use with flammable media or in an explosive environment
- not for use in moist and wet areas
- not for use in dirty or dusty environments
- not for use in aggressive environments (for example, atmosphere containing salt, corrosive vapors, etc.)
- independent constructional changes to the machine
- Operation of the machine with defective safety mechanisms or improperly installed or non-functional safety or protection mechanisms. (manipulation)
- not or improperly executed maintenance and commissioning measures

Any use going beyond that described in proper use is seen as improper. The manufacturer is not liable for any damage resulting from this. The user alone bears the risk.

2.1.3 Predictable misuse

The usage of other material types/thickness and sizes that are not included in the technical data is permitted.

The usage of operating materials that are not approved by the manufacturer is prohibited.

2.1.4 Warranty and liability

Independent modifications and changes to the machine are forbidden! Hardware and software changes to the machine may not be carried out without the approval of the company Variobotic GmbH. Damage that results from improper usage leads to the forfeiture of all warranty and compensation claims.

Spare parts Spare parts must correspond to the technical requirements determined by the manufacturer. This is always guaranteed for original spare parts from the manufacturer.

Wear parts Wear parts are not included in the warranty.

2.1.5 Introduction and instruction of people

Persons who work on the machine must comply with the defined requirements of this operating manual and must be regularly trained by the operator on the dangers involved in handling this machine. These instructions must be documented by the operating company.

The operating and technical personnel must have read and understood the operating instructions, in particular the safety chapter, as well as applicable national provisions before working on the machine.

The operating instructions and applicable national provisions are to be stored in such a way that they are accessible at all times to the operating and technical personnel.

All information and notes for the operation and maintenance on the machine are provided under consideration of our prior experiences and knowledge.

2.2 Personnel qualification

2.2.1 Basic requirements

Only people who can be expected to perform their work reliably are permitted as personnel. People who have an influenced responsiveness, for example through drugs, alcohol or medicine, are not permitted.

Observe the applicable local age and occupational guidelines when selecting personnel.

2.2.2 Operator

The operator fulfills the following requirements:

- The operating company authorizes them to use the product.
- They are physically and mentally able to properly operate the product without creating additional hazards.
- They are fluent in the official language for the site in writing and speech in order to be able to understand the manual and the operating interface of the control.
- They are familiar with the risks that exist when working with the product due to the instructions received and experience with the product.

2.2.3 Commissioning / maintenance staff

The commissioning / maintenance staff fulfills the following requirements:

- They are qualified through training and experience to commission the product as well as to perform any maintenance work on the product.
- They have fundamental experience with electrical controls.
- They have advanced experience with the functional safety and control of such products.
- The maintenance staff must additionally possess the qualification of the operator.

2.2.4 Electrician

The electrician is specially trained for the working environment in which they work. Due to their technical training, knowledge and experience as well as knowledge of the local standards and regulations, they are able to perform work on electrical machines and both detect and avoid any possible hazards independently.

2.2.5 Unauthorized persons

Unauthorized persons that do not fulfill the requirements described here are not familiar with the hazards affiliated with this machine. Thus, the risk of severe injuries or even death exists for unauthorized users.

2.3 Obligations of the user

Safety when handling the product can only be guaranteed if all required measures were taken. The user's due diligence includes the planning of these measures and inspecting their execution on the product.

In particular, the user shall ensure that:

- the product is only used properly and there is no misuse of the product.
- the product is only used in a proper, functional state and the functionality is inspected.
- the required personal protection equipment is provided and worn by the personnel for all work with the product.
- the operating manual is always in a legible state and completely available at all times where the product is being used.
- only qualified and authorized personnel operates the product.
- only qualified and authorized technical personnel with specific training repairs, maintains and performs improvements to the product.
- the personnel is instructed about the requirements for work safety and environment protection on a regular basis.
- that the personnel used has read and understood the operating manual.
- all safety and warning notes installed on the product are not removed and are easily legible and clear at all times.
- a hazard analysis according to the operating safety order (BetrSichV) or corresponding provisions must be executed before commissioning. This risk assessment must be documented.

2.4 Personnel obligations

Work with the product may only be performed by reliable, qualified and trained personnel. The manufacturer recommends regularly extending and refreshing this knowledge.

- Observe the legally permissible minimum working age!
- People who have been assigned to work with the product must have read and understood the operating manual before beginning their work.
- The basic provisions on work safety and accident prevent, such as wearing designated personal protection equipment, apply to all people who work with the product.
- The personnel has the obligation to immediately inform superiors of any determined faults and damage to the product. Work with the product must be stopped until the damage has been repaired.

2.5 Safety while working on electrical equipment



Danger!

Danger through electric shock!

When working on the control cabinet and components under power, there is mortal danger through fatal electric shock.

There may still be electrical voltage in the control cabinet after the machine is turned off with the main switch.

Work in the control cabinet may only be performed by an electrician under compliance with the five safety rules of electrical technology.

2.5.1 The five safety rules



	1. Unlock
	2. Secure against turning back on
	3. Ensure that there is no voltage
	4. Ground and short-circuit
	5. Cover or block off neighbouring parts under voltage

table 2.1: Safety while working on electrical equipment

- Behaviour** Always keep control cabinets closed! Only allow access for authorised people!
 Never hose down switch cabinets and other enclosures from electrical equipment in order to clean them.
 Only touch electrical equipment with dry hands!
 Do not use any metallic conductors during maintenance work on or near electrical equipment!
- Fuses** Only original fuses with the prescribed current may be used.

2.6 Fire fighting



Danger!

Hazard while fighting fire!

Further hazards may be caused as a result of improper use of fire extinguishers or use of other fire extinguishing equipment! For example, risk of a fatal electrical shock or injury caused by vapours or gases.

In the event of a fire, turn off the main switch from the machine or disconnect the machine from the power supply (pull plug, remove fuses). Otherwise there is a risk of an electrical shock and electrical fires cannot be effectively extinguished.

Only use non-residue CO2 extinguishers in the event of a fire.

If these are not available, use class A, B or C fire extinguishers (these fire extinguishers leave behind residue that is difficult to remove).

2.7 Safety during normal operation



Warning!

Risk of injury through electromagnetic fields

Persons who wear pacemakers or other active medical implants may be in danger when exposed to EMF.

Persons with active medical implants are forbidden to stay in the work and hazard area.

All safety provisions must be complied with while using the product. Changes to protective measures and safety equipment are not permitted.

In the event of disturbances, the product must be stopped immediately and until the disruption has been eliminated, the machine must be secured so that an unauthorized restart can be ruled out.

Do not work with the product if you are under the influence of alcohol, narcotics or medication.

3. Structure and function

3.1 Structure

The VarioShaker 540 with control box consists of the component separator (1) and the control box (2). The control box of the VarioShaker 540 must be installed in a control cabinet provided by the operator at the place of use. Due to safety reasons, the control box may not be used outside of a locked control cabinet.

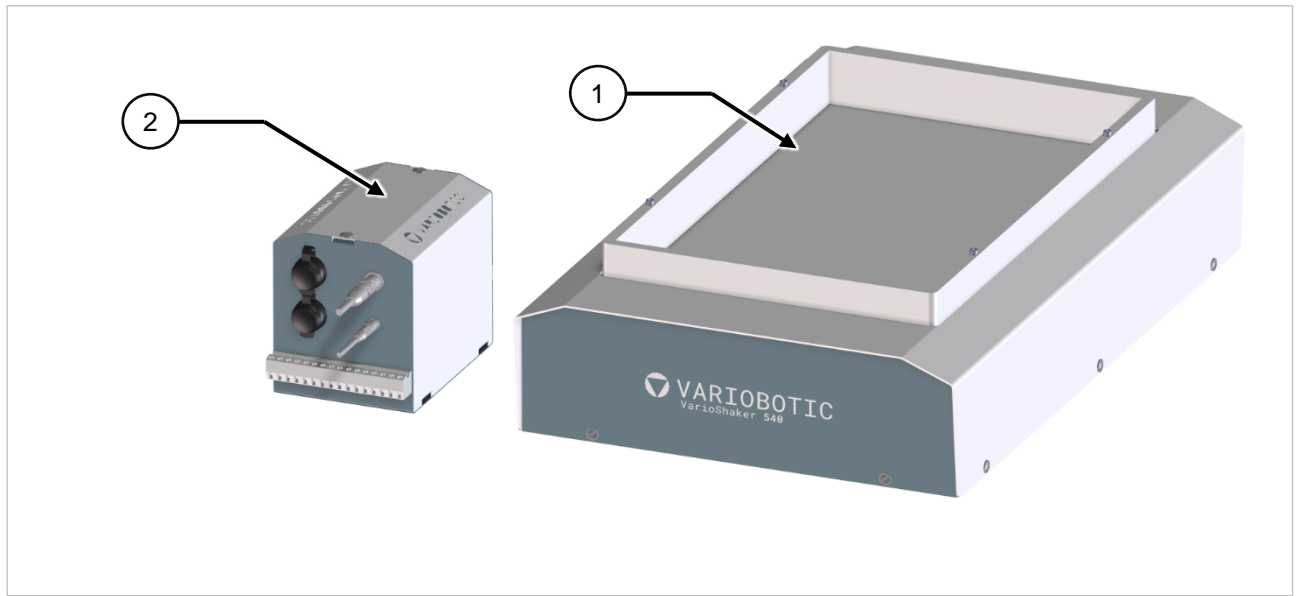

figure 3.1: Structure

3.2 Functional description

On the VarioShaker, components are separated and isolated using vibrations. If necessary, the components can be transported as specifically separated or in any areas from the vibrating plate. These movements must be adjusted to the user's needs.

The components are added to the VarioShaker as bulk material. Normally a hopper system is used for this. The valid tapping coordinates are determined through a camera system and the component is removed with a handling system.

A very high separate rate is achieved through the precise movement of the bulk material.

4. Transportation, installation and connection

Transport the device in its transport packaging to the place of use. Only unpack the device at the place of use. Check that all individual parts are present.

Note!

Material and damage to the device

Incorrect or unsuitable handling during transport can damage the device. Do not throw or drop the device.

Transportation and securing devices must not press against the transport packaging. Use suitable edge protection and intermediate layers.

When handling the control box, make sure that the contacts and terminals of the control box are not damaged.

The VarioShaker was designed and built so that it can be transported in a completely assembled state. Only use the transport packaging provided for transport.

4.1 Set-up and fasten

The following steps must be taken to ensure the reliable functionality of the VarioShaker. Proper operation cannot be ensured if these are not complied with.

The following installations are prohibited:

- Installation in rooms with explosion hazards
- Installation in environments with hazardous oils, acids, gases, vapours, dust, radiation, etc.



Caution!

Hazard through tripping and falling!

To rule out a tripping hazard, all device connections such as cables, hoses and pipes must be laid so that there are no tripping hazards through these.

Use cable ducts, bridges, covers, etc. for this purpose.

- After setting up and assembling the machine, ensure that the necessary connecting cables and lines are properly connected.
- Check that all covers and safety devices in the control box and on the machine are fitted or closed.
- Then check whether all danger points that have arisen from the installation have been properly removed, secured or marked.



4.1.1 Dimensions of the system base plate

The optimal functionality of the VarioShaker can only be achieved if the VarioShaker is installed in the machine in a vibration-free manner.



A **tip / note** from the manufacturer

The VarioShaker must be mounted on a plate with at least 55 kg dead weight. Used damping elements must be selected to be suitable for the mentioned net weight.

In the event that two VarioShakers are installed near each other, the respective device must be separately free of vibration.

4.1.2 Assembly on system base plate

The prepared base plate on which the VarioShaker is mounted must be aligned horizontally and vertically with a spirit level so that deviations of max. 0.5 mm per 1000 mm length are not exceeded.



A **tip / note** from the manufacturer

Pay attention to the orientation of the device for cable connection later. The device is provided with an orientation mark (coloured triangle) for this purpose. This orientation mark must also be used as a reference for the device coordinate system.

- 1) Place the VarioShaker on the bore pattern from the system base plate. (do not mount)
- 2) Use four M8 screws (illustration below item: 1) to fix the VarioShaker on the base plate.
- 3) Tighten the screws and check the fixed positioning of the screws.

4.1.3 Drill image for assembly

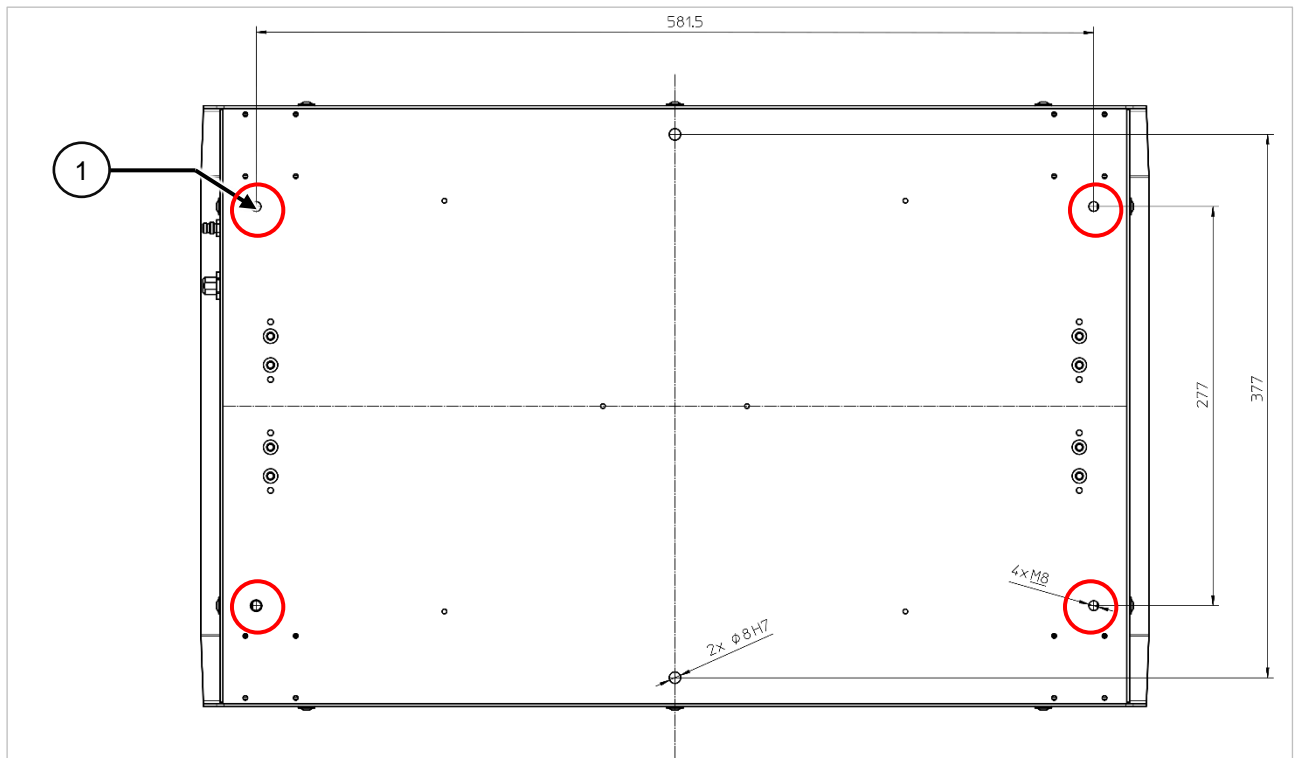

figure 4.1: Set-up and fasten

4.1.4 Assembly alternatives

Alternatively, you can fasten the VarioShaker through the base plate of the device with four M6 screws through the M8 (1) thread on the machine base plate. The front and back plate must be removed on the front and back side to reach the drill holes.

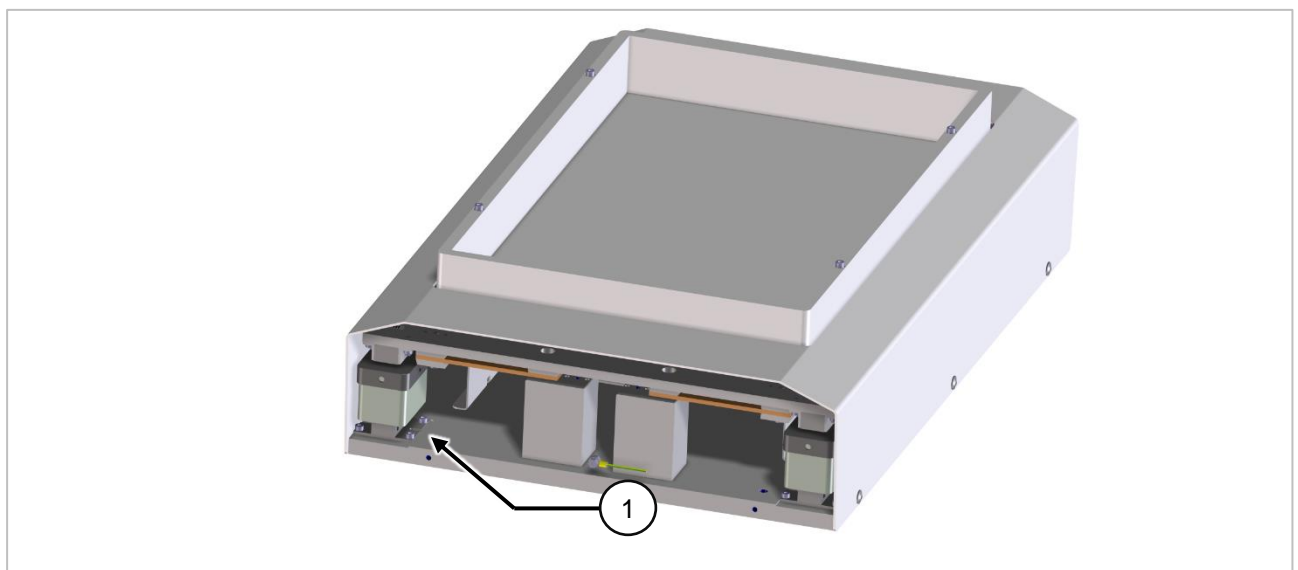

figure 4.2: Assembly alternatives

Tighten the front and back plate again after mounting the VarioShaker on the machine base plate.

Only a completely assembled device may be used!



4.2 Changing the vibration plate

It is possible to replace the vibration plate (A) for different applications and workpiece.

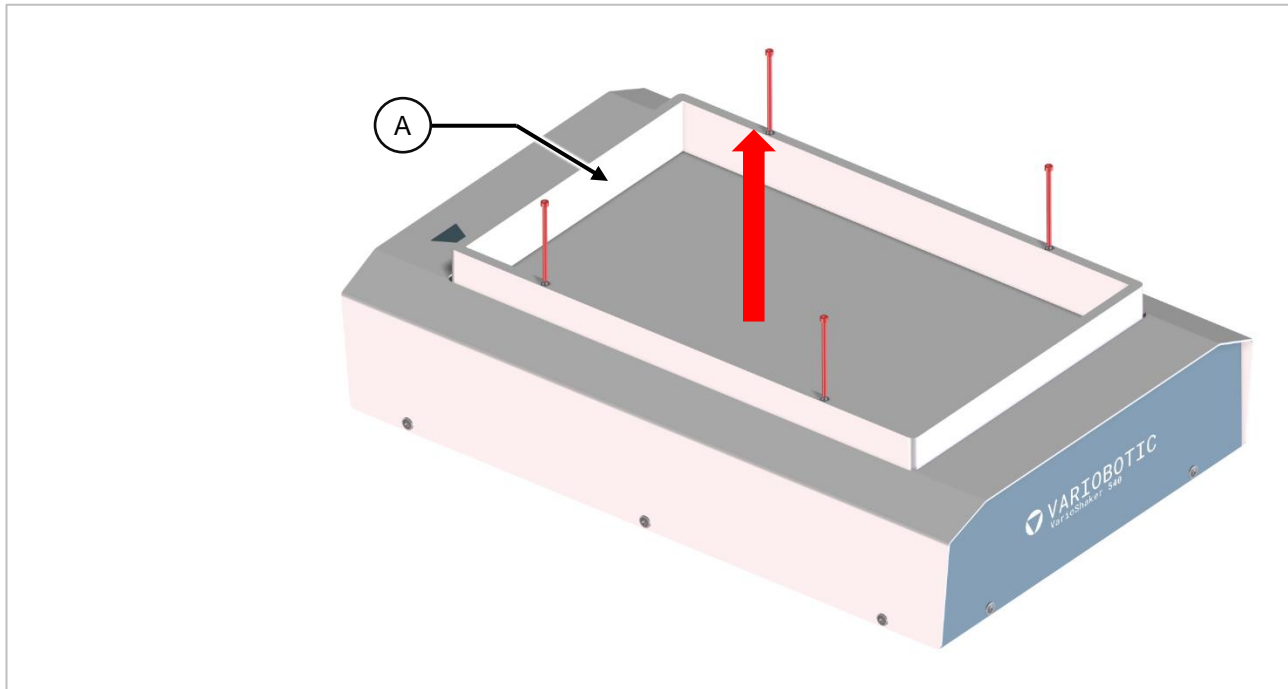

figure 4.3: Changing the vibration plate

- 1) To do this, first loosen and remove the four Allen screws DIN912-M5x70 (B).
- 2) Lift the vibratory plate (A) upwards and remove it.

Note!

Note on system or machine damage

Exposed magnets may attract metal chips and therefore damage the magnets and the vibration plate.

Clean the magnets every time the vibration plate is changed and ensure that there are no metallic chips on the magnets.

- 3) Insert the new vibratory plate and fasten it with the four Allen screws.

5. Electrical connection

5.1 Connection of the control box



! Danger!

Danger through electric shock!

When working on the control cabinet and components under power, there is mortal danger through fatal electric shock.

Work in the control cabinet may only be performed by an electrician under compliance with the five safety rules of electrical technology.



variobotic.de/downloadbereich

Observe additional documentation!

The control box for VarioShaker must be installed in a closed and locking control cabinet. All control signals can also be activated/used through the TCP interface

In addition to this brief description, refer to the electrical circuit diagram. The electric diagram as well as the TCP interface description are available for download on our service pages.

5.1.1 Connection strip form the control box

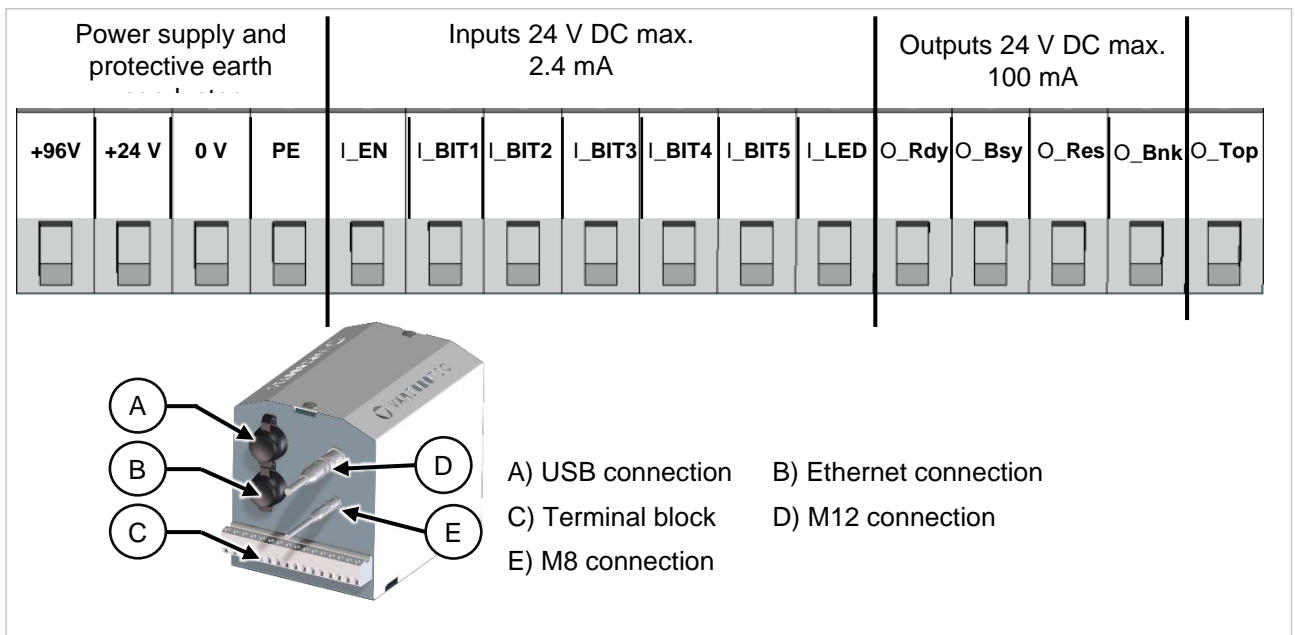

figure 5.1: Connection strip form the control box

PIN	Connection	Description
+96V	+96 V / 4A	- Power supply
+24 V	+24 V / 4A	(Combine mass from 24 V and 96 V)
0 V	0 V	The fuse is located in the housing
1	PE	Protective earth conductor
2	Inputs: 24 V DC max. 2.4 mA	I_EN
3		I_Bit1
4		I_Bit2
5		I_Bit3
6		I_Bit4
7		I_Bit5
8		I_LED
9		O_Rdy
10	O_Bsy	VarioShaker condition: busy
11	O_Res	Unassigned (reserved)
12	O_Bnk	Hopper on
13	Output 24 V DC max. 500 mA	O_Top
Other connections	Cable M12 (8-pin) and M8 (4-pin) each 5m	Control line between VarioShaker and control box
	Ethernet (TCP/IP)	Optional for control
	USB	USB port for update WebGUI

table 5.1: Connection strip from the control box

5.2 Connection to the VarioShaker

The VarioShaker is powered from the control box. Information on the power supply can be found in the chapter Technical Data.

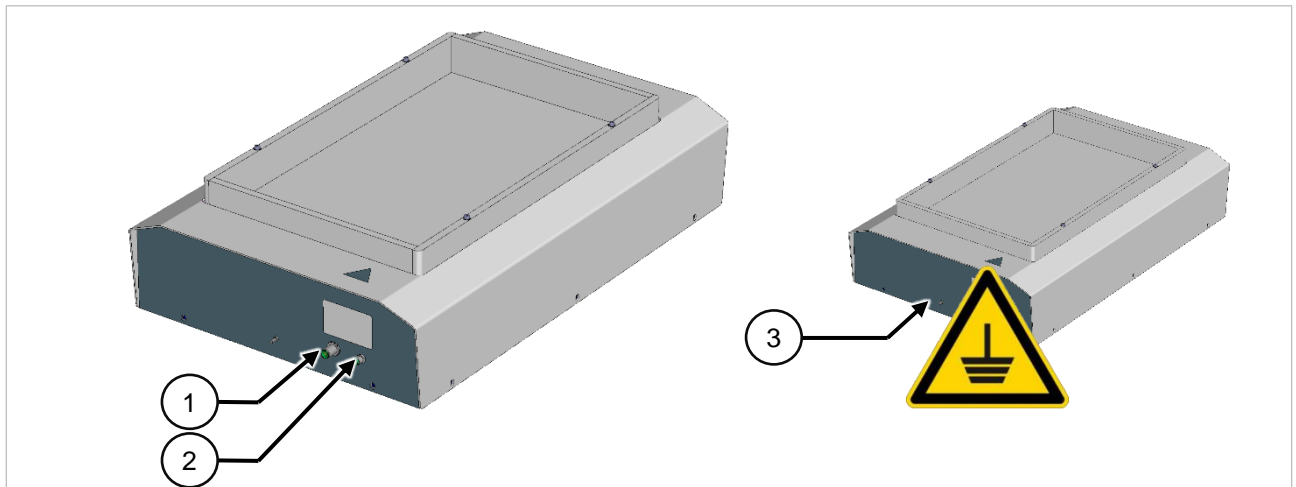

figure 5.2: Connection to the VarioShaker

The VarioShaker is supplied through the included M12-connection cable (8-pin) (1) and M8-connection cable (4-pin) (2). The cables are connected on the side of the VarioShaker.

An earthing cable must also be installed. Use the earthing pins (3) marked on the device for this purpose.

6. Operation and usage

Access to the control of the VarioShaker 540 is performed through the web interface. A browser-based user interface that is independent of the operating system and end device.



Warning!

Risk of injury through electromagnetic fields

Persons who wear pacemakers or other active medical implants may be in danger when exposed to EMF.

Persons with active medical implants are forbidden to stay in the work and hazard area.

Note!

Machine damage

Errors in the programming may lead to significant machine damage.

Only authorized and qualified experts with technical training may perform this task.

6.1 VarioShaker user interface

To activate the user interface of the VarioShaker, you must first establish a connection via your network. Use a standard web browser for this.



A tip / note from the manufacturer

The manufacturer recommends using the “Google Chrome” web browser. Use the predefined factory settings:

IP: 192.168.2.20 | Subnetmask: 255.255.255.0 | Gateway: 192.168.2.1

In the user interface settings (gear symbol in the top right), after initial login, you can adjust your own network configuration (IP address, subnet mask and gateway) or use the automatic assignment through the DHCP server. - See the “Settings (Yellow)” chapter in the operating instructions.

If the connection was successful, the start screen shown here will appear.



figure 6.1: VarioShaker user interface

- Red frame = Preset and file management
- Green frame = Clip Editor
- Blue frame = Sequence Editor
- Yellow frame = Settings

6.2 Resetting network settings

The control box is configured with a fixed IP address (192.168.2.20) in the delivery state - see chapter VarioShaker user interface. In this chapter you can find out how to reset the control box to the delivery state.



Danger!

Danger through electric shock!

When working on the control cabinet and components under power, there is mortal danger through fatal electric shock.

Work in the control cabinet may only be performed by an electrician under compliance with the five safety rules of electrical technology.

- 1) Open the control box installed in the control cabinet. Here you will find the RESET (A) lever.

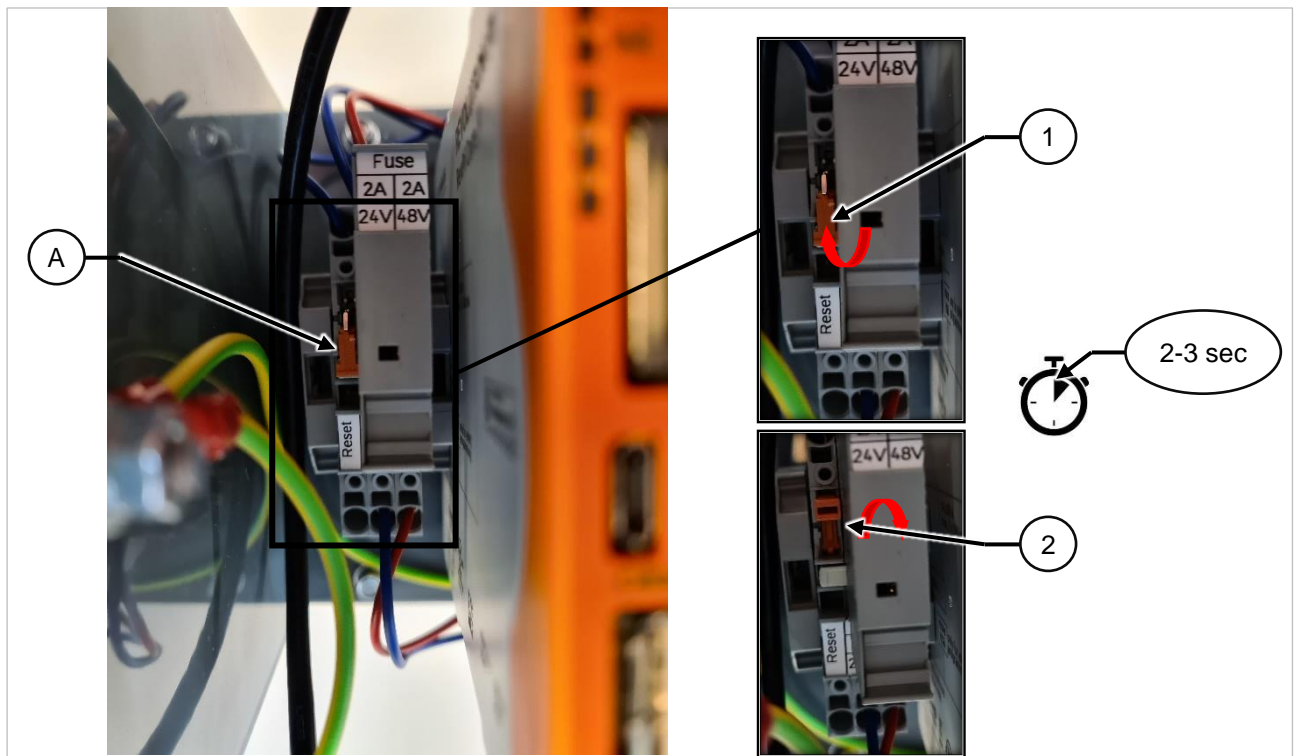

figure 6.2: Resetting network settings

- 2) In order to reset the control box, press the lever (A) carefully up against the resistance.
 - ✓ Wait a few seconds
- 3) Push the lever back down into the initial position
- 4) Close the control box

Contact the manufacturer should there be any questions or problems during resetting!

6.3 Preset and file management (RED)

In the preset and file management, you will find the PRESET CLIPS (templates, presettings), MY CLIPS and MY SEQUENCES.

6.3.1 PRESET CLIPS

There are preset clips to simplify the setup of different functions.

This function is described in detail.

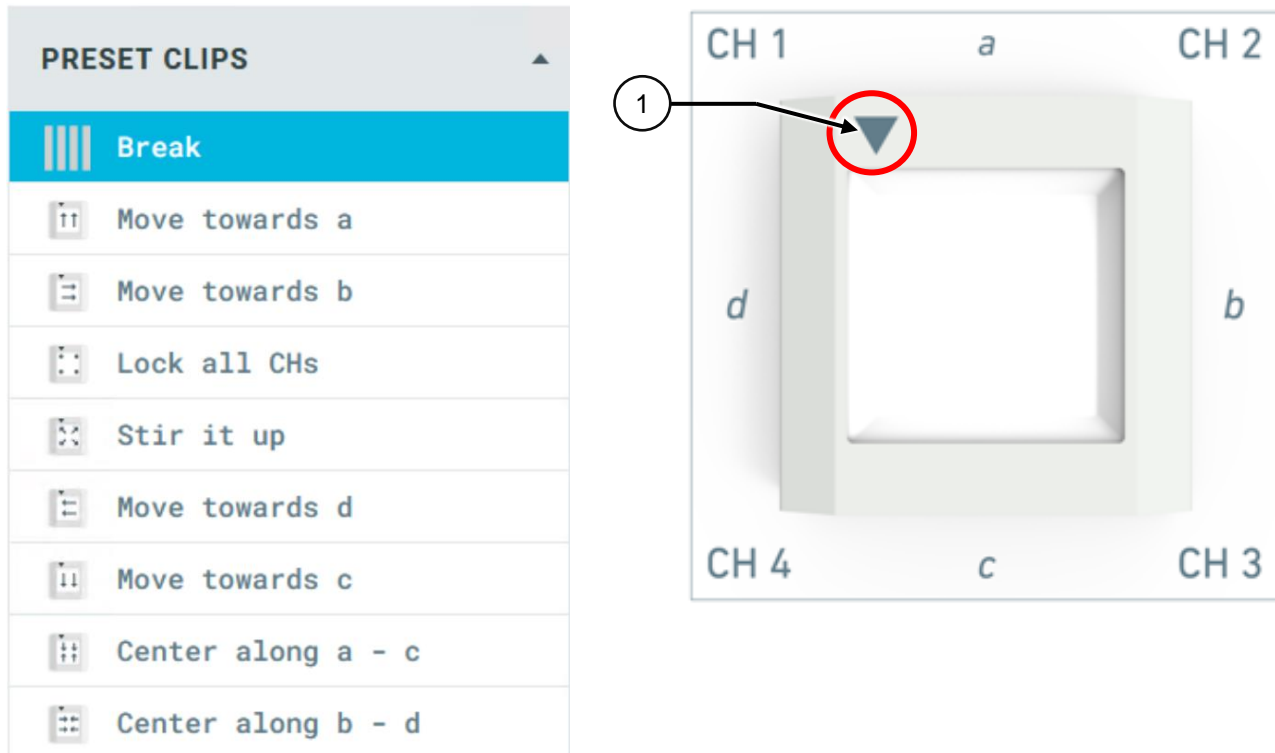





figure 6.3: PRESET CLIPS

In order to detect the correct alignment of the channel, the corner of your VarioShaker is marked with a triangle (1) as well as the icons of the presets.

The individual “channels” begin in clockwise direction and the page names in the form of letters on the triangle. The channels always stand for a corner.

 Break	Set all amplitudes to zero Serves as a break in the sequence to let vibrations come to an end or to create transitions
 Move towards a	Move parts to side a Setting the frequency and adjusting the amplitude to your case
 Move towards b	Move parts to side b Setting the frequency and adjusting the amplitude to your case
 Lock all CHs	All corners on a block Causes a very quick stop of the vibration.

Note!

Note on system or machine damage

The function LOCK ALL CH keeps the corners on BLOCK and causes a very fast stop of the oscillation.

If the amplitude was set too high and the VarioShaker moves constantly to BLOCK, this will lead to increased wear and damage.





 Stir it up	Completely rearrange parts through complete jump movement Setting the frequency and adjusting the amplitude to your case
 Move towards d	Move parts to side d Setting the frequency and adjusting the amplitude to your case
 Move towards c	Move parts to side c Setting the frequency and adjusting the amplitude to your case
 Center along a / c	Center parts between the sides a and c Setting the frequency and adjusting the amplitude to your case
 Center along b / d	Center parts between sides b and d Setting the frequency and adjusting the amplitude to your case

table 6.1: PRESET CLIPS

By clicking a PRESET CLIP, it will be accepted in the CLIP EDITOR.

You can now adjust this CLIP to fit the respective conditions. Then save the adjusted clip under MY CLIP.



A tip / note from the manufacturer

The presettings of the PRESET CLIP make it easier for you to find the right settings. The phase and amplitude are preset by the manufacturer.

In most cases, only the frequency has to be adjusted to the installation situation. Then you can optimize the amplitude.

6.3.2 MY CLIPS

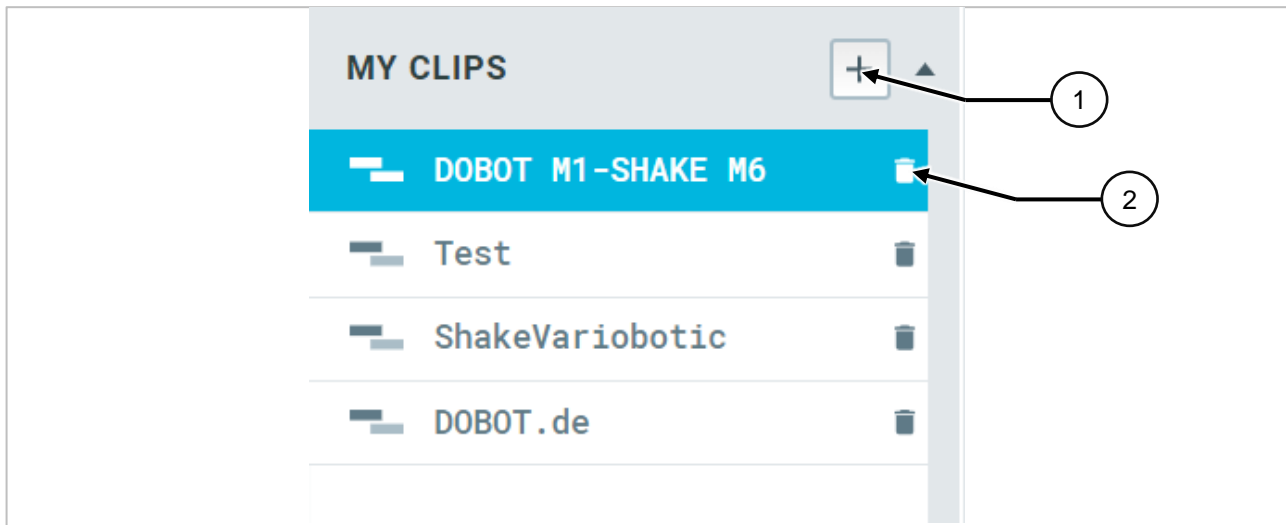

figure 6.4: Preset and file management (RED)

By opening the MY CLIPS area, you can manage the clips you have created.

Create new clips by pressing the PLUS symbol (1).

A field to enter the description will appear.

Blue clips are now active in the CLIP EDITOR.

The respective clip can be deleted using the waste bin symbol (2).

6.3.3 MY SEQUENCES



figure 6.5: Preset and file management (RED)

By opening the MY SEQUENCES area, you can manage the sequences you have created.

Create new sequences by pressing the PLUS symbol (1).

A field to enter the description will appear.

Green sequences are active.

The respective sequence can be deleted using the waste bin symbol (2).

The number before the designation (see 1 or 10 above) indicates the SLOT where the sequence was saved.



A **tip / note** from the manufacturer

A SLOT is the BIT CODED position where the sequence is saved.

By opening the digital I/O on PIN 1 for start and 2 -5 for the BIT selection, you can open the sequences without needing the WEB GUI.

6.4 CLIP EDITOR (green)

6.4.1 Basics clip EDITOR

Different movement and vibration effects can be achieved in the CLIP EDITOR by setting the frequency, amplitude and phase movement.

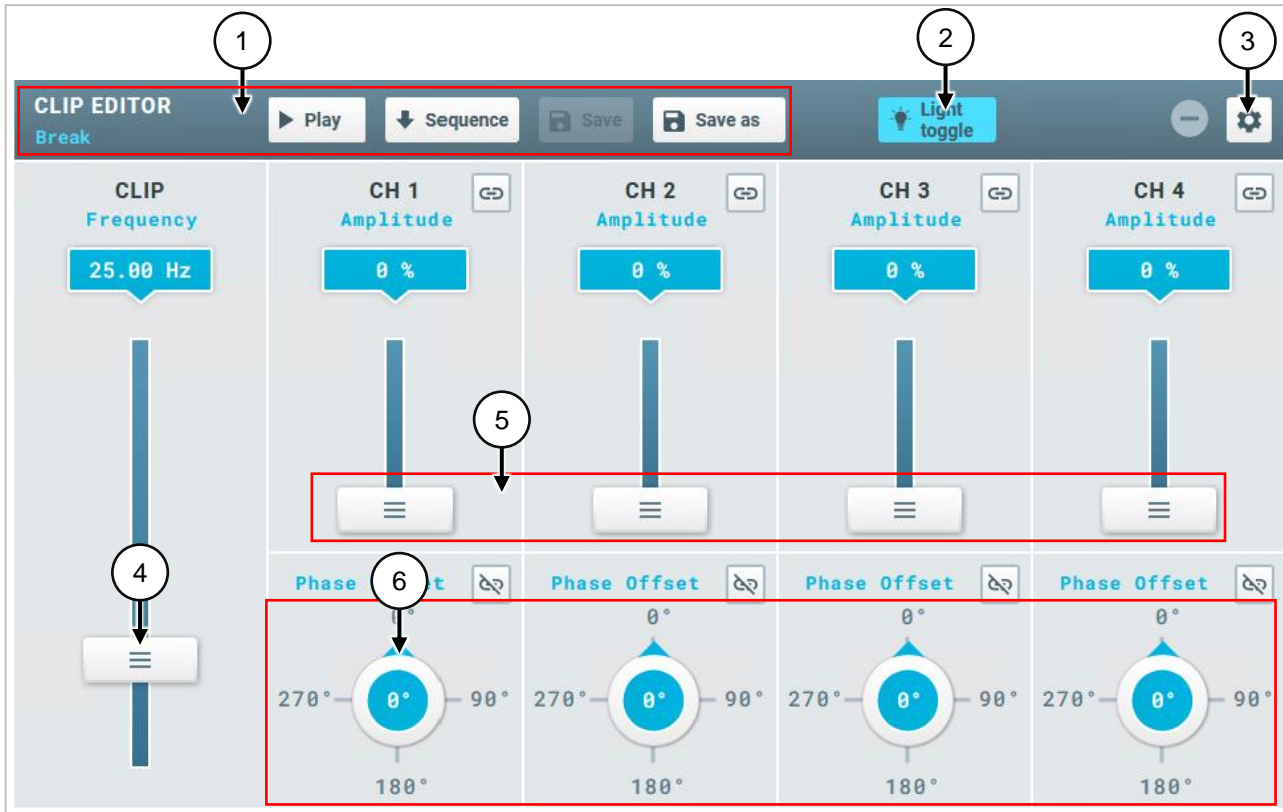

figure 6.6: Basics clip EDITOR-1

- 1) Function buttons >>> Playing and saving in the CLIP EDITOR
- 2) Button *LIGHT TOGGLE* >>> Switch the transmitted light on/off while setting up image processing. The light is switched through the control in automatic mode.
- 3) Button *SETTINGS* >>> You can reach the Settings mask (yellow) by pressing this symbol.
- 4) Slider Frequency >>> Specification in Herz (Hz)
- 5) Slider Amplitude >>> Specification in percent (%)
- 6) Knob for phase movement >>> Specification in degrees (°)



A tip / note from the manufacturer

By clicking on the respective numbers (in blue), you can enter the desired values through a connected keyboard as well.

The optimal functionality of the VarioShaker is dependent on the component that moves / should be separated, the vibration plate and the structure of the machine in which the VarioShaker is installed.

6.4.2 Function buttons

The currently selected CLIP (1) is found in blue writing under the description CLIP EDITOR.

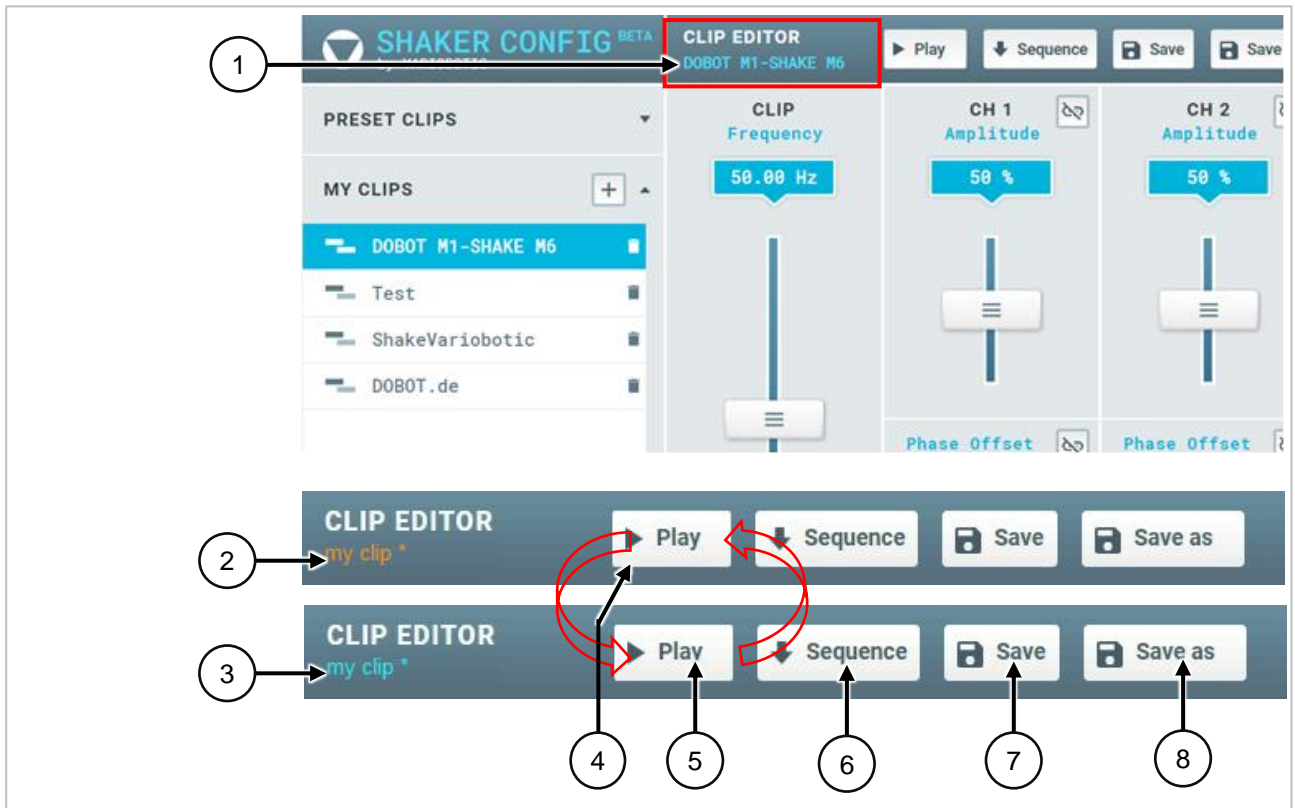

figure 6.7: Function buttons-2

If the CLIP settings are changed, the font color will be changed to orange (2). The font color remains the same until the CLIP is saved again. The font is blue again after saving is complete (3).

- With the PLAY button (4), a setting can be tested / played in the CLIP EDITOR and the symbol changes to PAUSE.
- With the PAUSE button (5), the playing of the clip can be disrupted.
- With the SEQUENCE (6) button, you can move the CLIP into the SEQUENCE EDITOR. The prerequisite is an active sequence in the SEQUENCE EDITOR.
- With the SAVE button (7), the previous CLIP is overwritten.
- With SAVE AS (8), a new entry (new name must be assigned).

If a CLIP is moved to the SEQUENCE EDITOR, these are independent units and have no further link. This means that adjustments to the sequence or in MY CLIP are independent of each other.

The CLIP automatically received a new name in the SEQUENCE as well.

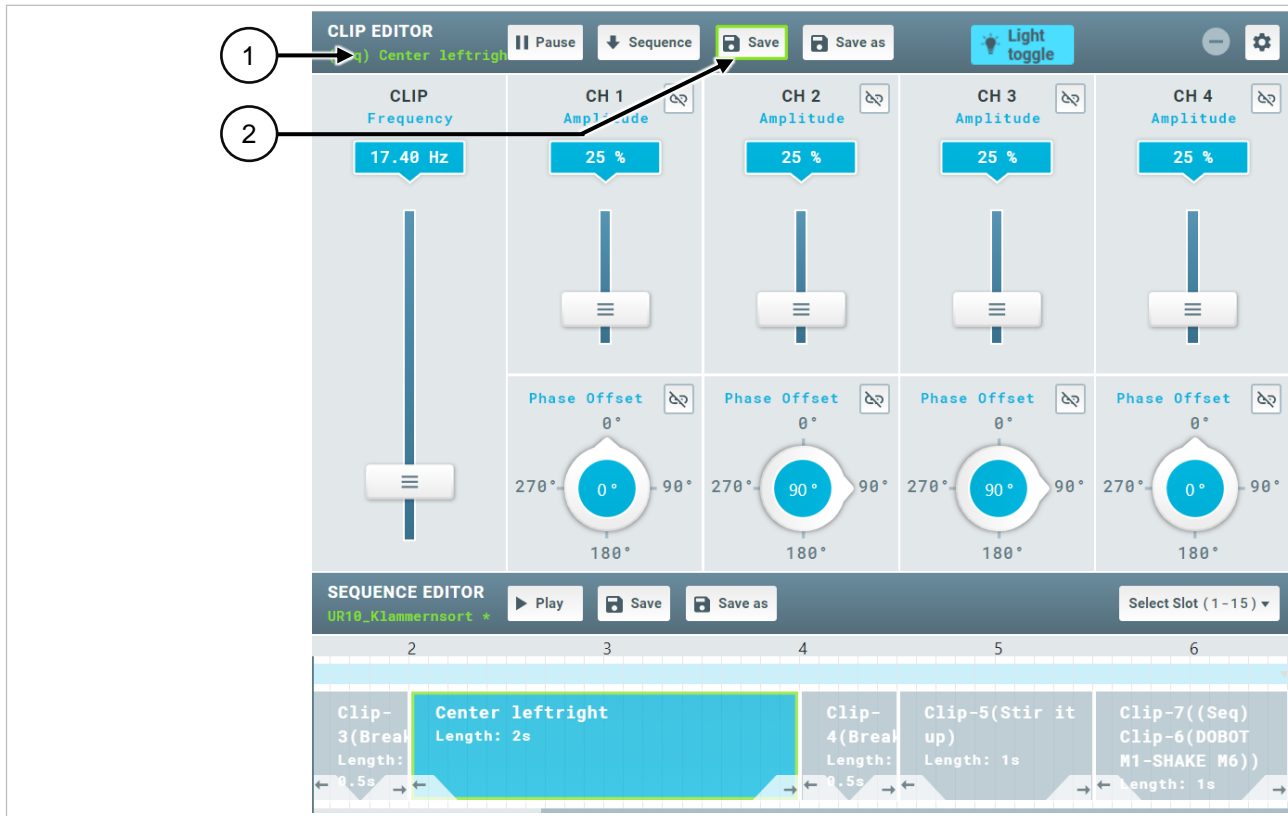

figure 6.8: Function buttons-3

This is additionally made clear by showing the name of the selected CLIP (here from the SEQUENCE) in green (1).

The SAVE button (2) also indicates that it is saving to the SEQUENCE through a green frame.

6.4.3 Other functions

If you would like to change the amplitude or phase of multiple controllers at the same time, you can link the controllers.

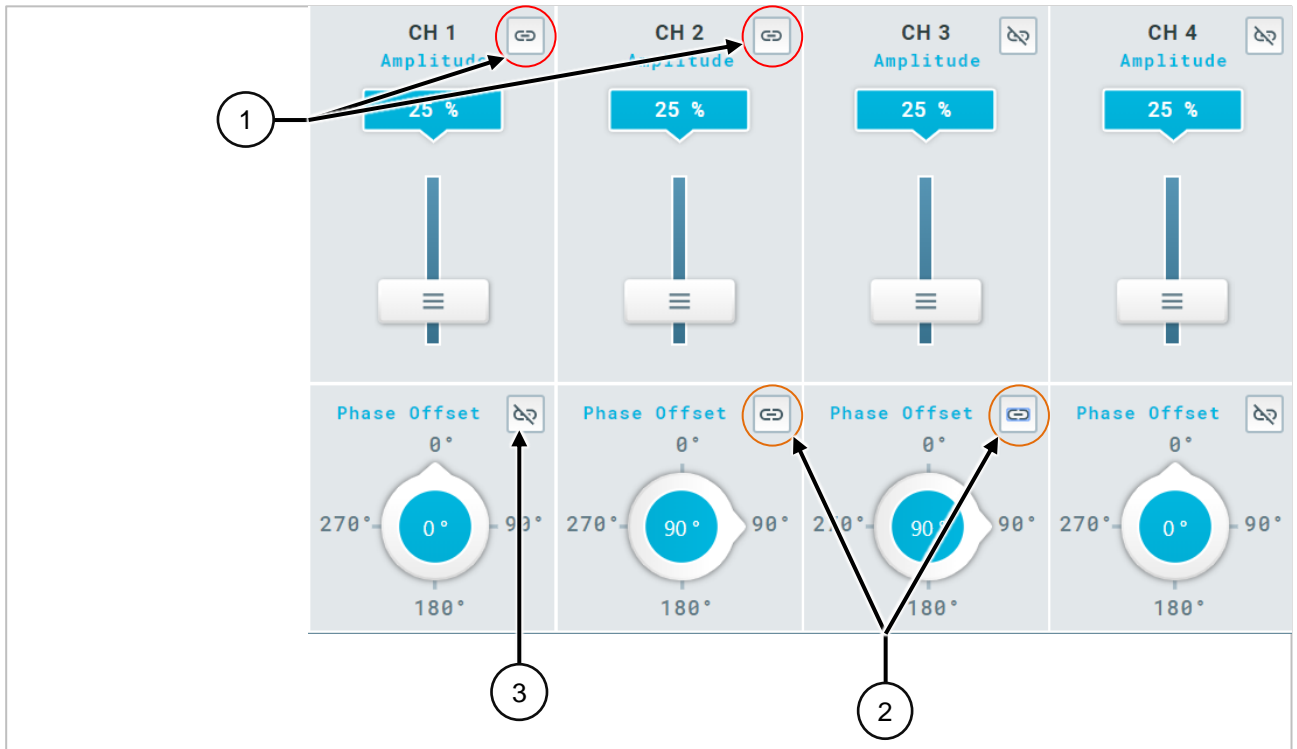

figure 6.9: CLIP EDITOR (green) - Other functions

If for example CH1 and CH2 are moved together in their amplitude, they can be linked by pressing the button (1).

In this example, the phase from CH2 and CH3 (2) is also linked and changed together.

You can see an individual controller (not linked) based on the symbol (3).

6.4.4 Introduction to the creation of CLIPS

A movement of the components on the VarioShaker is generated through the correct combination of frequency, amplitude and phase.

The PRESETS help to easily and quickly understand dependencies.



figure 6.10: CLIP EDITOR (green) - Introduction to the creation of CLIPS

Load STIR IT UP.

The frequency and amplitude must be initially present so that an effect is created when PLAY is pressed.

Areas between 15 and 30 Hz are a good range, for example, for the STIR IT UP movement.

Once the excitation frequency has been found, the amplitude can be adjusted to the best effect.

After this, the clip should be saved under MY CLIPS, for example, with a machine identification.

6.5 SEQUENCE EDITOR (blue)

6.5.1 Basics of the SEQUENCE EDITOR

Complete process sequences can be generated from individual CLIPS.

As an example, components can initially be collected from the top, bottom, left and right in the middle to then be sorted in a new order.



figure 6.11: SEQUENCE EDITOR (blue) - Basics of the SEQUENCE EDITOR-1

Similar to the CLIP EDITOR, the active sequence is shown here as well.

- You can save a sequence once with PLAY.
- SAVE and SAVE AS have the same function as with the CLIP EDITOR.

Clips changes in the SEQUENCE EDITOR are only saved in the sequence.



figure 6.12: SEQUENCE EDITOR (blue) - Basics of the SEQUENCE EDITOR-2

A clip marked in the SEQUENCE EDITOR is illustrated in the CLIP EDITOR (GREEN) and can be changed there.

The clip can be renamed and its length changed by double clicking on a clip in the SEQUENCE EDITOR.

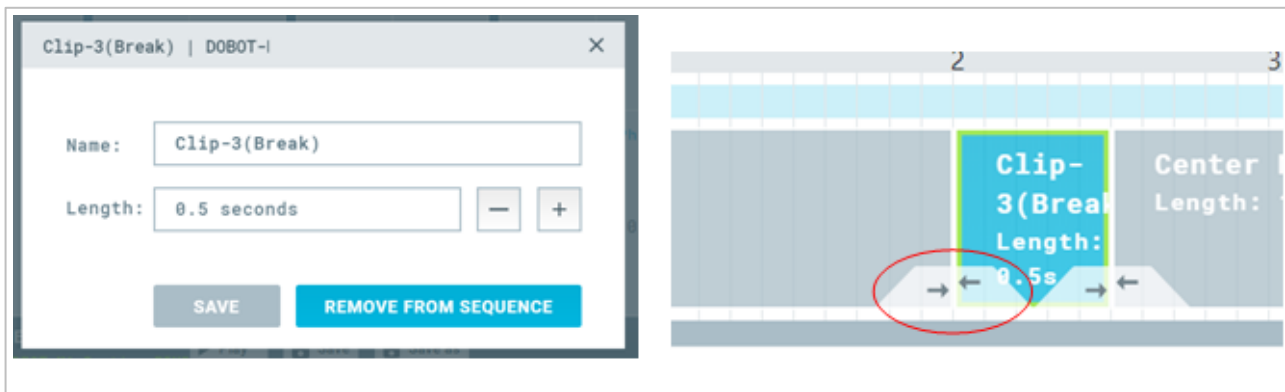

figure 6.13: SEQUENCE EDITOR (blue) - Renaming a clip

The sequence of the clips can be changed to the left and right by using the arrows underneath the clips.

6.5.2 SLOT assignment

In order to assign a matching SLOT to a sequence, it must be marked under MY SEQUENCE.

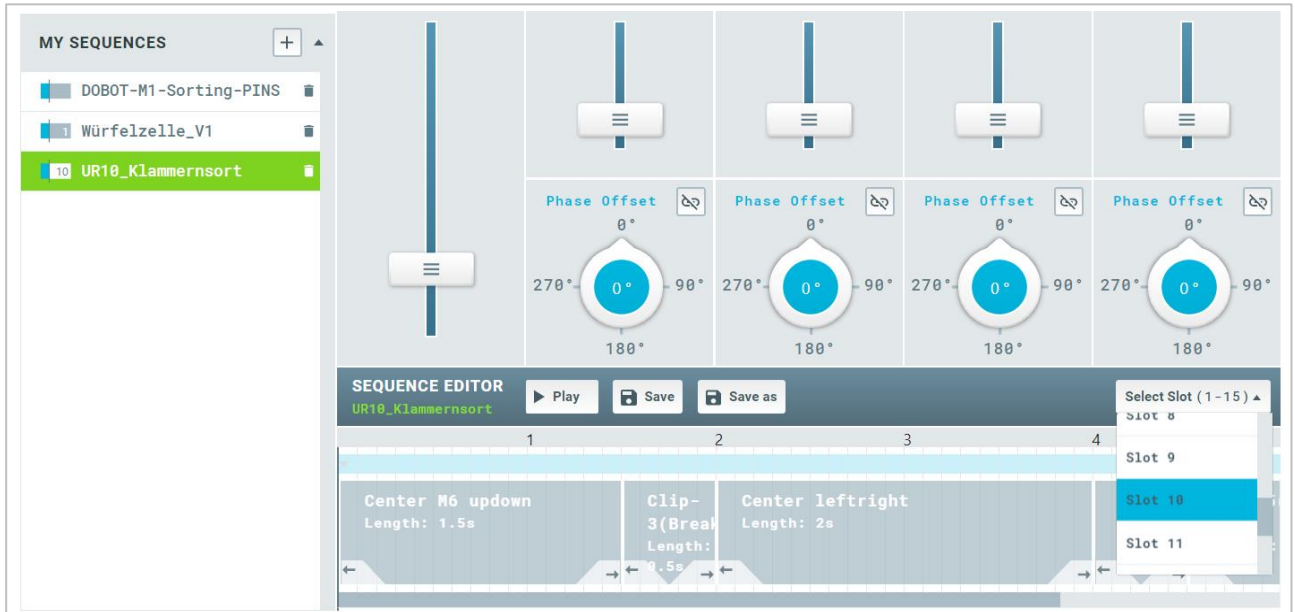

figure 6.14: SEQUENCE EDITOR (blue) - SLOT assignment

Then the matching SLOT can be assigned in the drop down menu. If the selected SLOT was already assigned, there will be a notification on the display that the SLOT was overwritten.

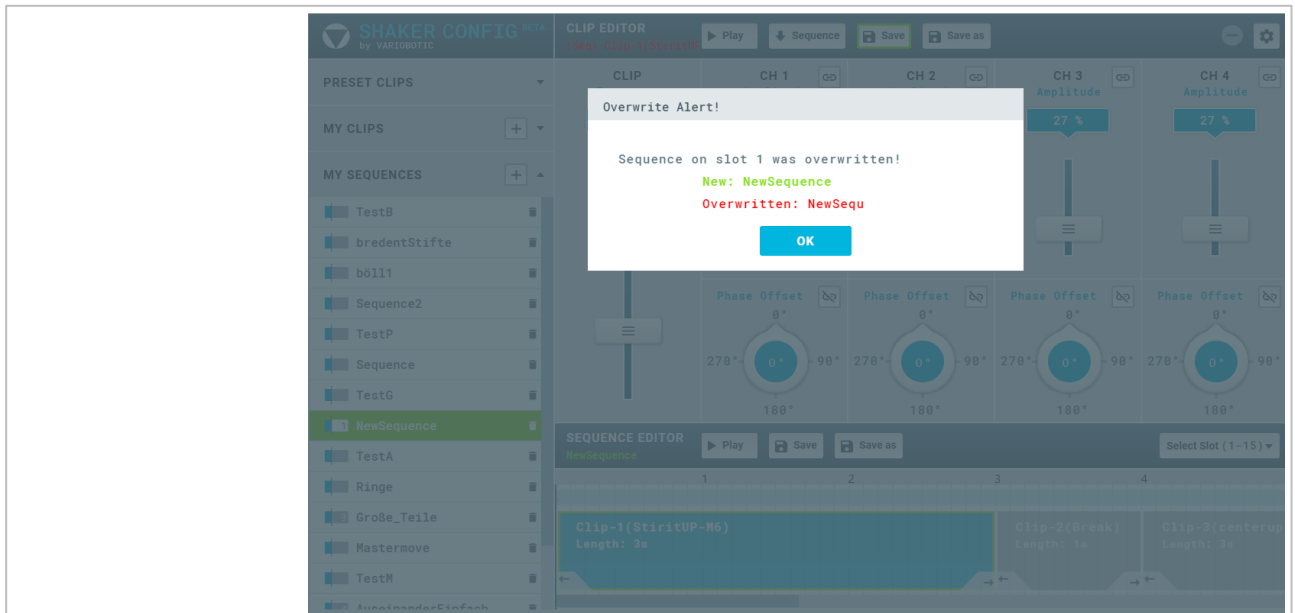

figure 6.15: SEQUENCE EDITOR (blue) - Overwrite SLOT

6.6 Settings (Yellow)

The following images are visualized when opening the settings.

6.6.1 Presettings (Preferences)

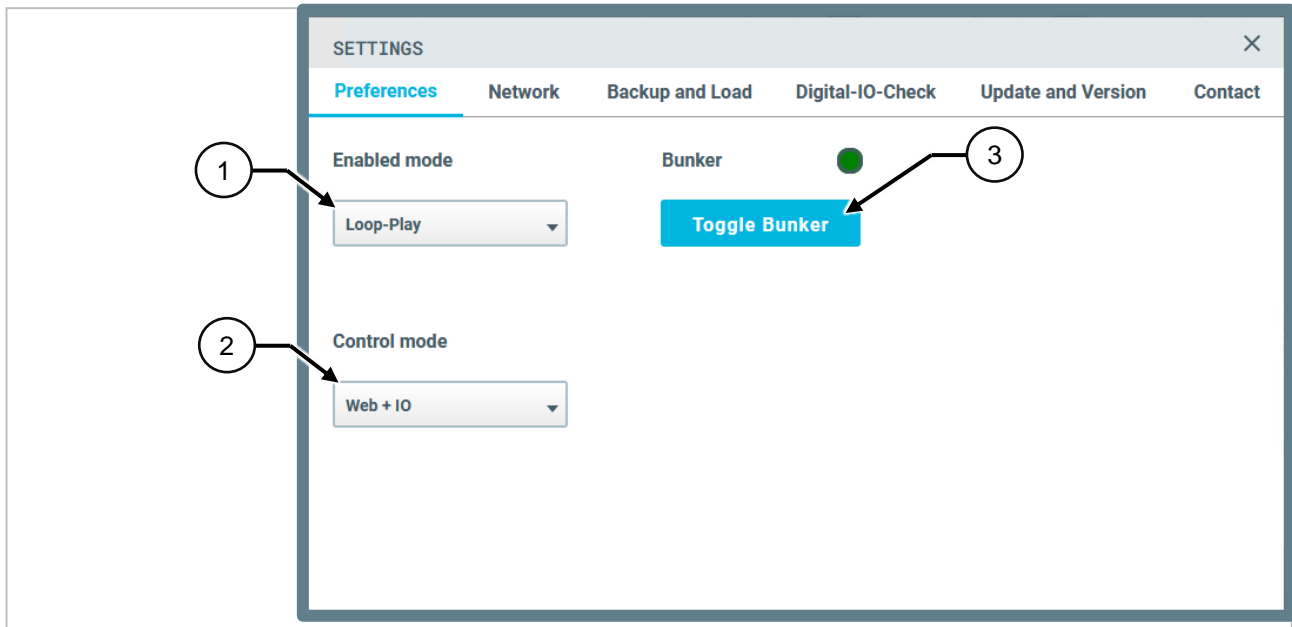

figure 6.16: Settings (Yellow) - Presettings (Preferences)

- 1) **Enabled mode:** In the drop-down menu, you can preset which mode should be activated.
 - ✓ Loop-Play >>> The sequences are repeated continually as long as the enable signal is present
 - ✓ Single-Play >>> The sequence will be run through once; the enable signal is sufficient as a trigger.

- 2) **Control mode:** The selection of the VarioShaker control can be preset in the drop-down menu
 - ✓ Web + IO >>> Control through input signal and output signal (in / out)
 - ✓ Web + TCP >>> Control through Transmission Control Protocol (TCP) network protocol.

6.6.2 Network configuration (Network)

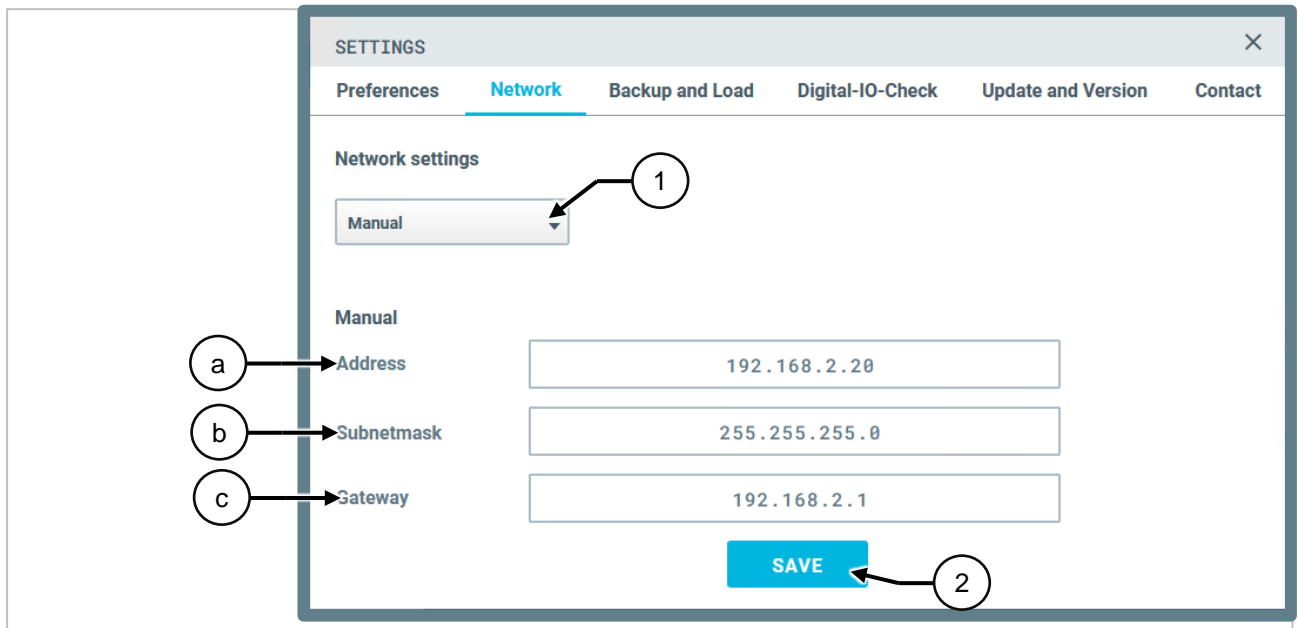

figure 6.17: Settings (Yellow) - Network configuration (Network)

Use the drop-down menu (1) to select either DHCP (Dynamic Host Configuration Protocol) or MANUAL.

With the aid of the DHCP setting, the control box automatically receives the assignment of the network configuration (IP-address) through the connected server, provided that it is configured for DHCP assignment.

Under MANUAL, you can set your own network configuration.

- ✓ a = IP-Adress
- ✓ b = Subnetmask
- ✓ c = Gateway.

Confirm your entry by clicking on the SAVE button (2).



Capital reference - resetting to network settings

How to reset the network configuration to the delivery state is described in the chapter: Resetting network settings.

6.6.3 Data backup and restoration (backup and load)

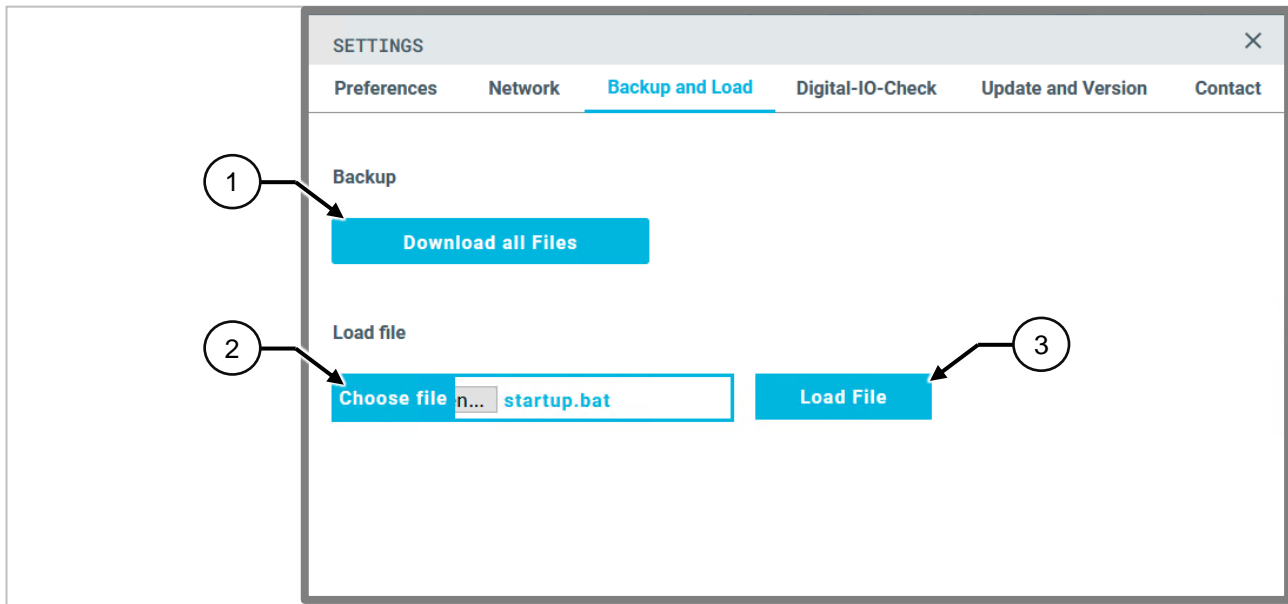

figure 6.18: Settings (Yellow) - Data backup and restoration (backup and load)

Through the *DOWNLOAD ALL FILES* button (1), a back-up file is downloaded with all *MY CLIPS* and *MY SEQUENCES*.

You can select a file to upload to the control box through the *CHOOSE FILE* button and upload with the *LOAD FILE* button.

6.6.4 Input and output check (digital IO check)

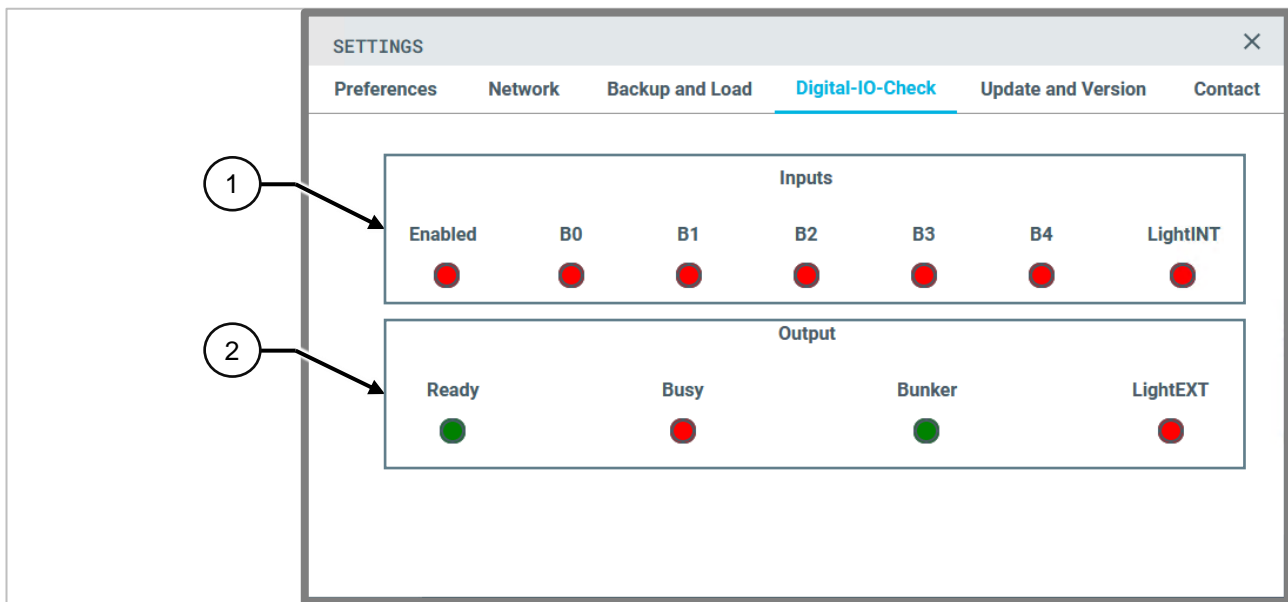
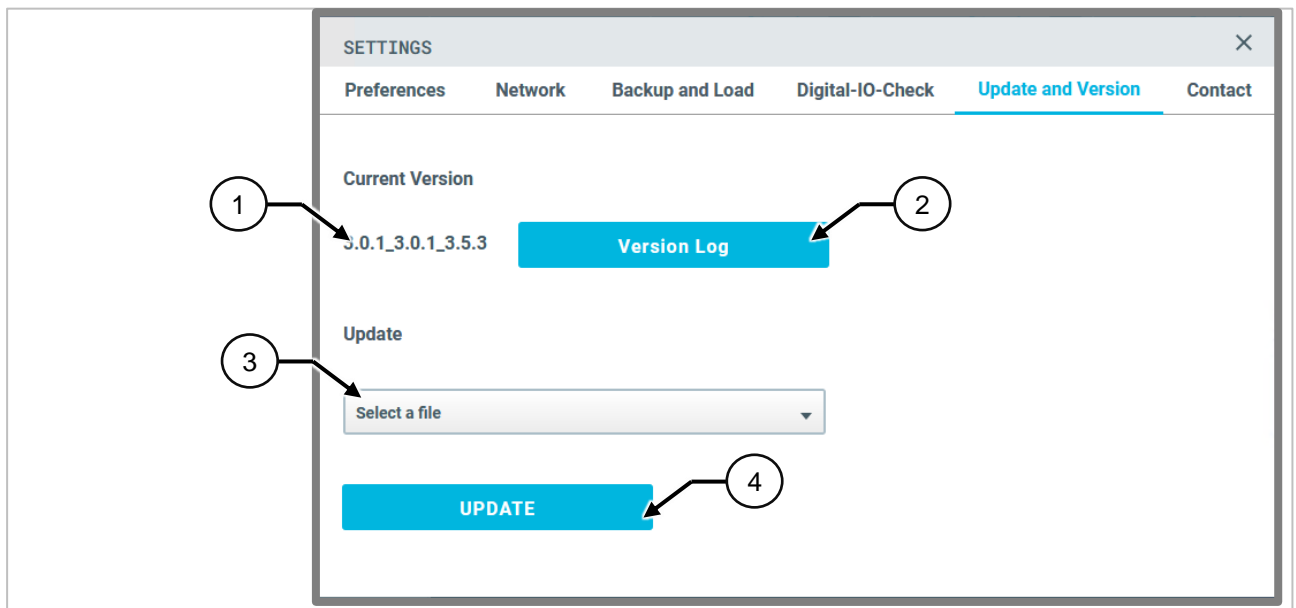

figure 6.19: Settings (Yellow) - Input and output check (digital IO check)

- 1) Input >>> The switch state of the input signals is visualized in this area (red = signal is not present / green = signal is present).
- 2) Output >>> The switch state of the output signals is visualized in this area (red = signal is not present / green = signal is present).

6.6.5 Update and Version (Update and Version)



Update and Version (Update and Version)

- Current Version (1) >>> The current version number as well as the Python version is displayed here.
- With the *VERSION LOG* (2) button, you can get to the log file
- Update >>> Select the update file through the drop-down menu (3) and confirm with the *UPDATE* (4) button.
 - ✓ The update will be performed.



variobotic.de/

A tip / note from the manufacturer

In order to get the most out of your VarioShaker, you should update the software at regular intervals.

Free updates are available on request from the manufacturer. In your request, always specify the respective serial number (see nameplate) as well as the software version number (1) from our customer service employees.

Our contact data can be found on our service pages in this manual and on our homepage at: www.variobotic.de.

6.6.5.1 Step-by-step instructions

Following your inquiry, you will receive two files from us, which should be handled as follows:

- 1) Use a FAT32 formatted empty USB stick and create a folder on it with the file name "updates".
- 2) Copy the two sent files into this created folder of the USB stick.
- 3) The update files should look as follows:
 - ✓ YYYY-MM-DD_XXXX.ruetteltisch.tar.xz (CONTROLLER)
 - ✓ YYYY-MM-DD_XXXX.webtisch.tar.xz (GUI)

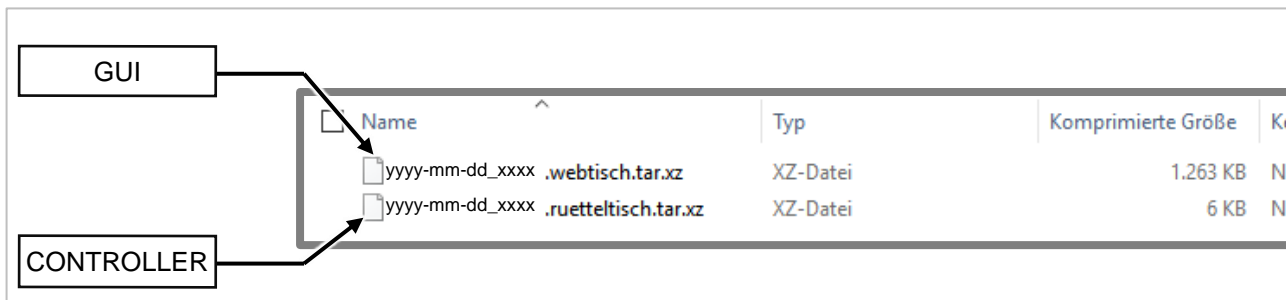
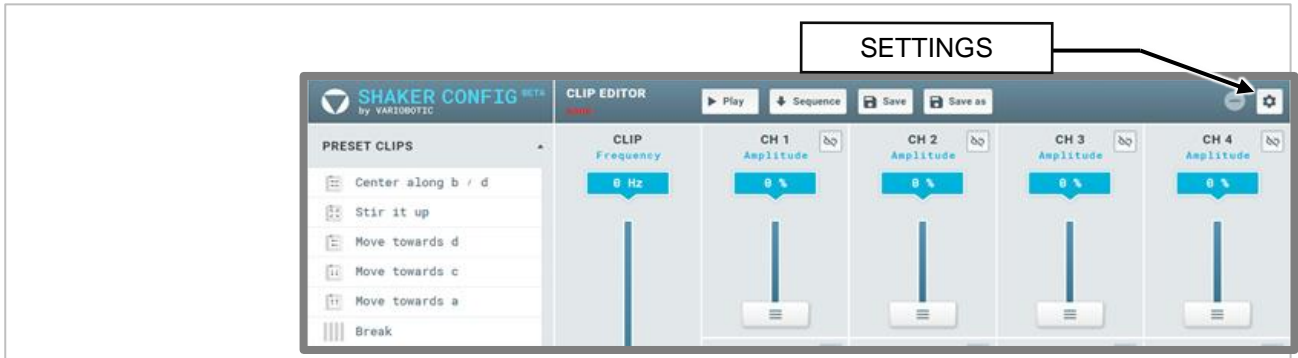
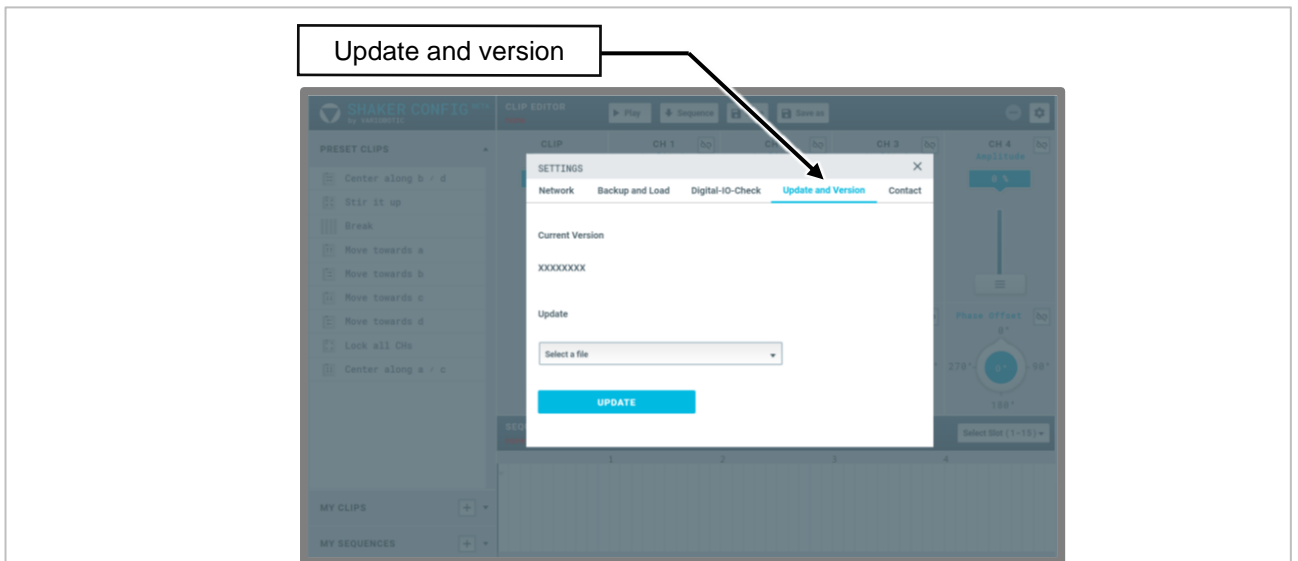

figure 6.20: Update and Version (Update and Version)

- 4) With the system switched on (vibrating table does not necessarily have to be activated), insert the USB stick into the USB socket on the outside of the control box housing.



- 5) Open the WebGUI in your web browser and select the *UPDATE AND VERSION* tab under *SETTINGS* (gear icon in the upper right corner).



Now first select the file from the web interface (webtisch.tar.xz) in the dropdown menu and click on *UPDATE*.



A tip / note from the manufacturer

This process takes about 2 minutes, but it may also require more time. In this case, the page will be reloaded, but the web interface will not open. Please wait and reload the page after a few seconds until the web interface is displayed again.

- 6) After this process is finished, repeat this process with the file of the controller (ruetteltisch.tar.xz).

The vibration table and the web interface were now updated with the current version.

6.6.6 Contact



Contact

By clicking the website www.variobotic.de (1) or scanning the QR code, you will be forwarded directly to the sites from the manufacturer Variobotic GmbH should you be connected to the internet.

6.7 Tips for operation

If your VarioShaker 540 has been set up according to your desires, you can use the full potential of the VarioShaker. The following help will show you how to make the most of the basic functions for productive work.

However, the following tips assume that you have read and understood the previous description of how to operate the VarioShaker.

Pos.	Function / Effect	Execution / experience
Tip 1	Quick shutdown or locking of the vibrating bowl	pull all magnets to block = 100% amplitude
Tip 2	Selection of the best frequency for your components - slow cautious approach	Set amplitude of all magnets to 10 - 15 Hz, no phase movement and then slowly go through the frequency range from the bottom to the top in order to find out the resonance frequency.
TIP 3	Selection of the best frequency for your components - our experience	Start with an initial frequency of 20 - 35 Hz in order to find the best setting.
TIP 4	Selection of the best frequency for your components - our experience	Smaller parts can be subject to vibration with higher frequencies.
TIP 5	Selection of the best frequency for your components - long pieces with large surfaces	The resonance frequency is more in the lower frequency range for long parts with a large surface. Test a frequency of approximately 20 Hz.

table 6.2: *Tips for operation*

7. Maintenance and repair

Only reliable, trained or instructed repair personnel may perform repair work on this machine. Knowledge of the operating manual is required.

The repair personnel must correspond to the personnel qualifications and requirements described in this document. See the section Personnel Qualification.



Warning!

Risk of injury through electromagnetic fields

Persons who wear pacemakers or other active medical implants may be in danger when exposed to EMF.

Persons with active medical implants are forbidden to stay in the work and hazard area.

Note!

Machine damage

Improperly performed work may lead to significant machine damage.

Only authorised and qualified experts with technical training for mechanical / electrical systems may perform this task. The operator must be able to see the complete work area of the machine.

7.1 General measures for service and maintenance

The VarioShaker is maintenance-free. Should, however, any repair or maintenance work be necessary, the device must be disconnected from all energy sources.

To do this, disconnect the plug connections of the M12 connection cable (1) and the M8 connection cable (2) on the VarioShaker.

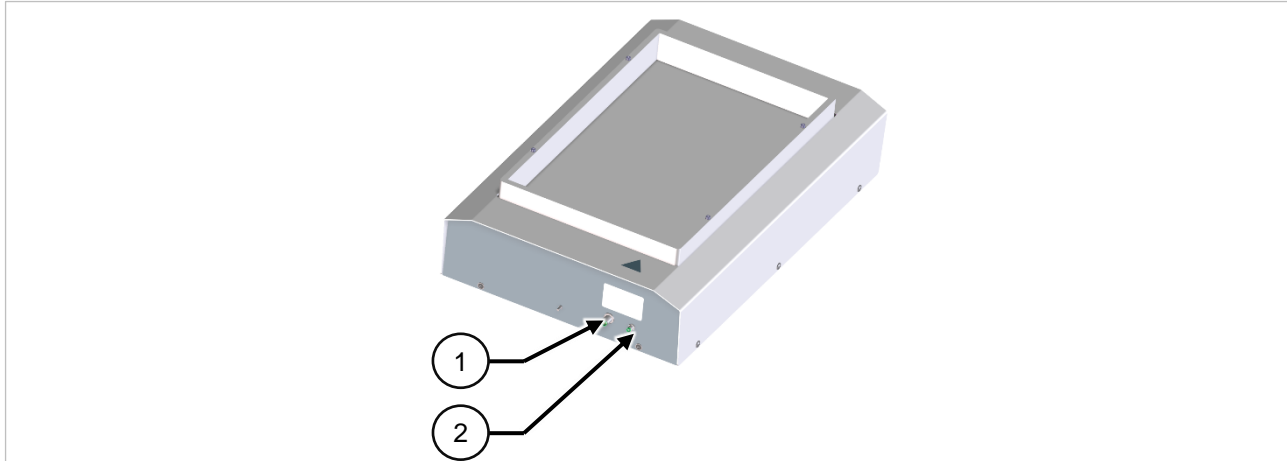

figure 7.1: General measures for service and maintenance

Make sure that all tools, cleaning cloths and other materials are removed from the work area after completion of the maintenance work. Remove liquids in a proper and environment-friendly manner.

Before commissioning the machine, check the proper assembly and function of all safety equipment.

Should there be any further questions about repair and maintenance work, please contact the manufacturer under the contact options specified in the Service chapter.

8. Service and maintenance

If the machine can no longer be started or if functional disruptions occur during operation, technical personnel should examine the machine for repair. Do not allow non-expert people to execute repair work or program changes to the machine.

Only reliable, trained or instructed repair personnel may perform repair work on this machine. Knowledge of the operating manual is required.

The repair personnel must correspond to the personnel qualifications and requirements described in this document.



Danger!

Danger through electric shock!

When working on the control cabinet and components under power, there is mortal danger through fatal electric shock.

Work in the control cabinet may only be performed by an electrician under compliance with the five safety rules of electrical technology.

8.1 Contact data

Before you contact our service, take note of this in advance.

- The exact machine name (nameplate)
- The article/serial number of the machine (nameplate)

8.1.1 In the event of disruptions and technical problems:

Contact data: **Company**

Variobotic GmbH

Dr.-Carl-Schwenk-Str. 24
89233 Neu-Ulm (Germany)

Telephone: +49 731 8507 2200

or

E-mail: info@variobotic.de

8.2 Spare and wear parts

Independent modifications and changes to the machine are forbidden! Hardware and software changes to the machine may not be carried out without the approval of the company Variobotic GmbH. Damage that results from improper usage leads to the forfeiture of all warranty and compensation claims.

Wear parts Wear parts are not included in the warranty

Spare parts Spare parts must correspond to the technical requirements determined by the manufacturer. This is always guaranteed for original spare parts from the manufacturer. Contact the manufacturer for this.

9. Disassembly and disposal

During disassembly of the machine, observe the applicable operational and legal provisions. Dispose of all materials in an environment-friendly manner and corresponding to the currently valid legal and operational provisions. Continue to observe the following notes!



Danger!

Danger through electric shock!

There may still be electrical voltage in the control cabinet after the machine is turned off with the main switch. When working on the control cabinet and components under power, there is mortal danger through fatal electric shock.

Work on electrical parts or components of the machine may only be executed by a trained electrician! Keep the control cabinet closed if no work is being done in it. Only use certified and approved electrical tools!

9.1 Disassembly for disposal

- Disconnect network connection cable and disconnect feed to the control box
- Dispose of all materials separated corresponding to the existing provisions

9.1.1 Notes on disposal

9.1.1.1 Within the European Union



If your product is marked with this symbol, used electrical/electronic products should not be disposed of with normal residual waste. A separate collection system is available for these products in accordance with the implementation of European member states.

Consumed electrical/electronic devices must be handled separately and in agreement with the legal regulations, which prescribe the correct handling, disposal and reprocessing of such products.

9.1.1.2 In countries outside of the EU

If you would like to dispose of this product, please contact your local authorities to receive information on proper disposal.

10. Technical data

Type	VarioShaker 540
Item number:	VA-Art-00046
year of construction:	2021

table 10.1: Technical data

10.1 Dimensions

Dimensions (L x W x H):	approx. 660 x 425 x 160 mm
Weight:	27.5 kg
Vibration area:	POM/PE white, 540 mm diagonal (Usage area approx. 475 x 290 mm), smooth
Optional vibration area:	On request

table 10.2: Dimensions

10.2 Climatic and environmental requirements

Operation:	+05 °C ... +40 °C
Environment:	<ul style="list-style-type: none"> ▪ not for use with flammable media or in an explosive environment ▪ not for use in moist and wet areas ▪ not for use in dirty or dusty environments ▪ not for use in aggressive environments (for example, atmosphere containing salt, corrosive vapors, etc.)

table 10.3: Climatic and environmental requirements

10.3 Electrical and software-technical requirements

Power supply:	24V DC 4A and 96V DC 4A
Switch on duration (ED):	< 50%
Connections:	M12 (8-pin) and M8 (4-pin) cable per 5m - control line between VarioShaker and control box USB port for update WebGUI Ethernet (TCP/IP) > optional for control
Control:	Separate control box in control cabinet Contact assignment see circuit diagram
Dimensions control box:	180 x 132 x 163 mm (L x W x H)
Software:	WebGUI via standard web browser

table 10.4: Electrical and software-technical requirements

10.4 Maximum component size and component weight

The maximum part size always depends on the optimum number of parts for the respective process. This part number must be determined empirically dependent on the orientation behavior and the tapping process. The most stable process is normally achieved when the tapping area is covered with components up to 2/3.

A general specification about the maximum part weight cannot be provided. The weight threshold is dependent on the component geometry and the material. If the components are too heavy, they cannot be re-oriented in a process-safe manner. The parts should always be checked for suitability in advance.

11. Annex

11.1 Switch and connection plan control box



variobotic.de/downloadbereich

Observe additional documentation!

The control box for VarioShaker must be installed in a closed and locking control cabinet. All control signals can also be activated/used through the TCP interface

In addition to this brief description, refer to the electrical circuit diagram. The electric diagram as well as the TCP interface description are available for download on our service pages.

11.2 For your notes

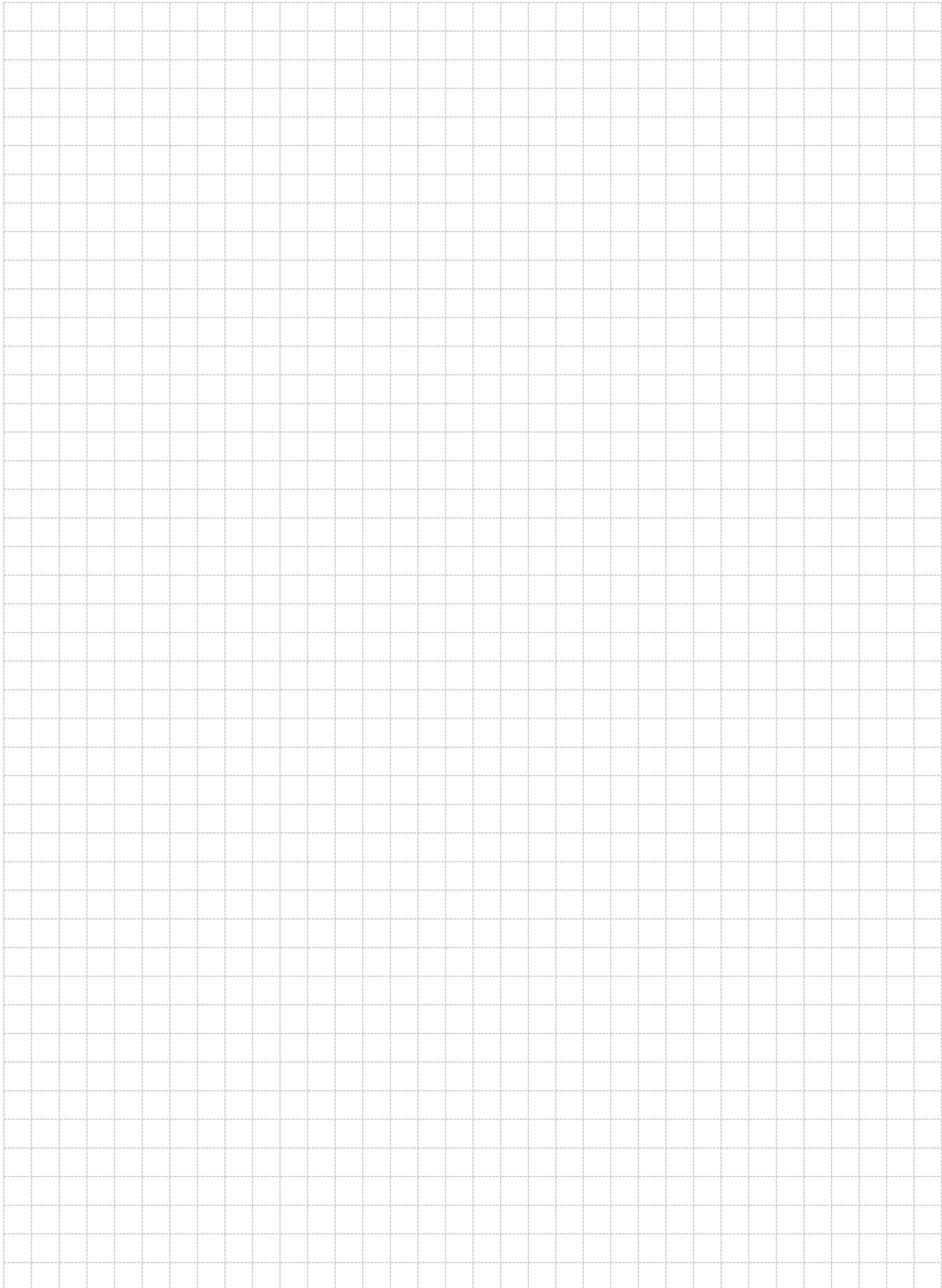

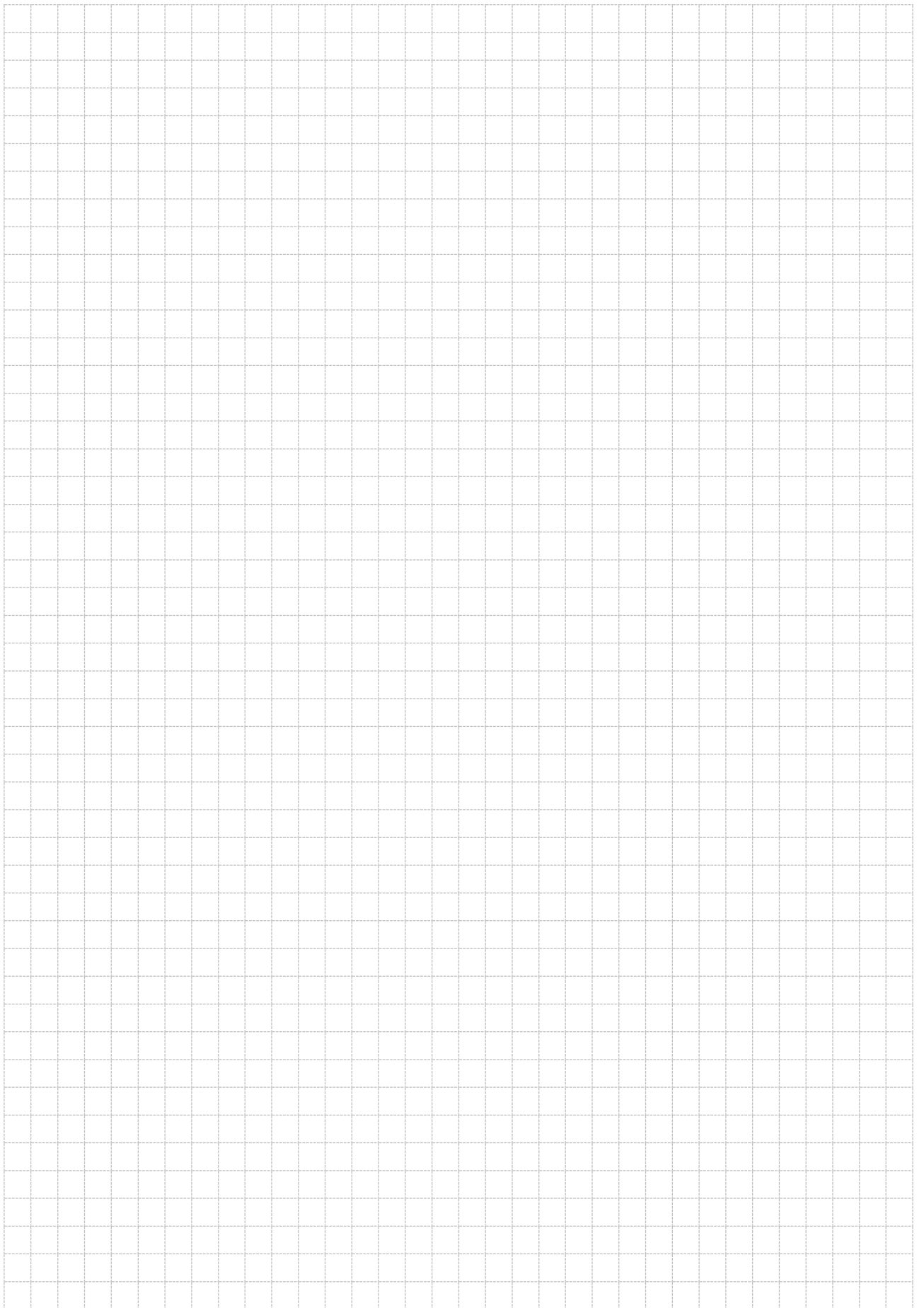

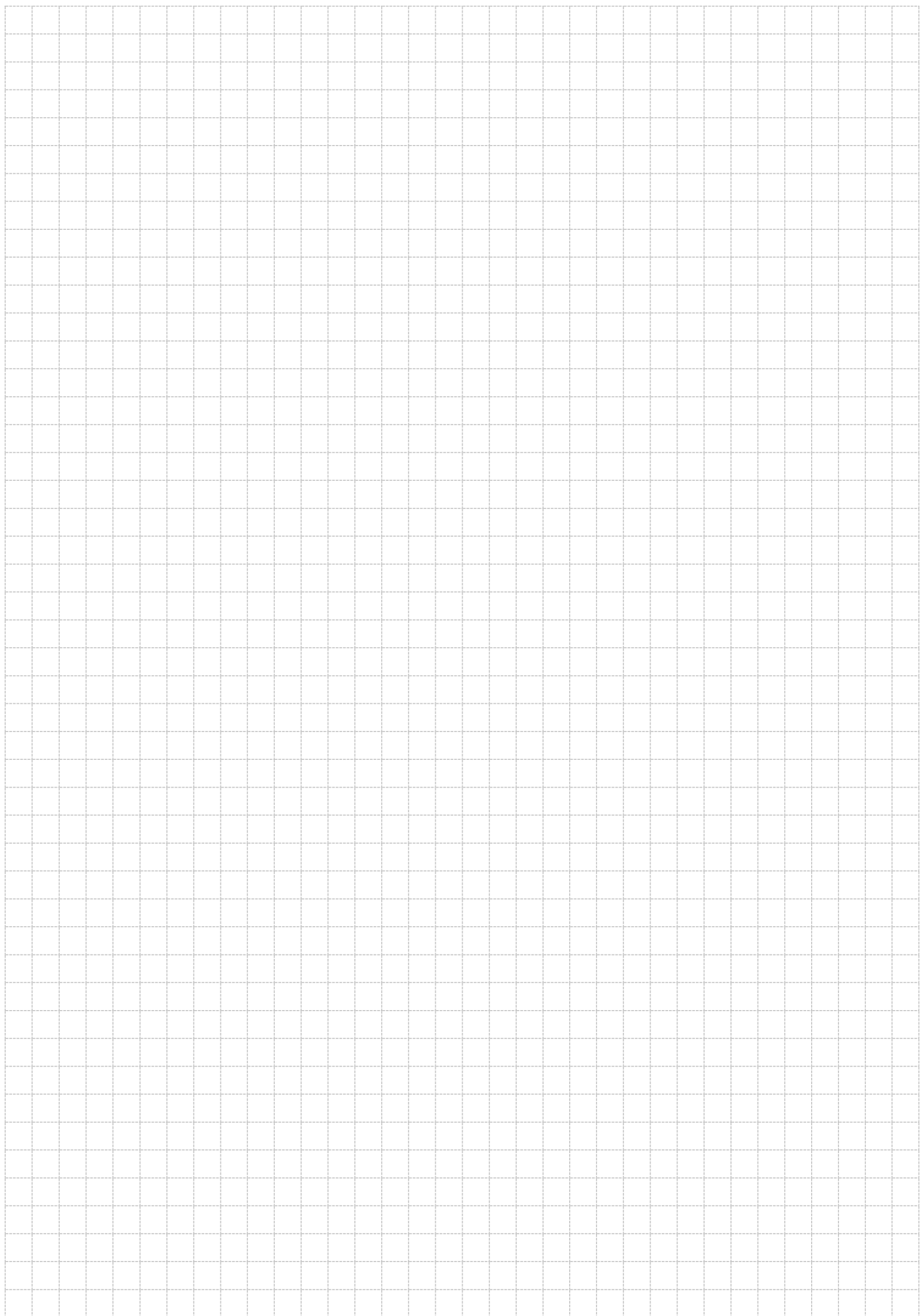

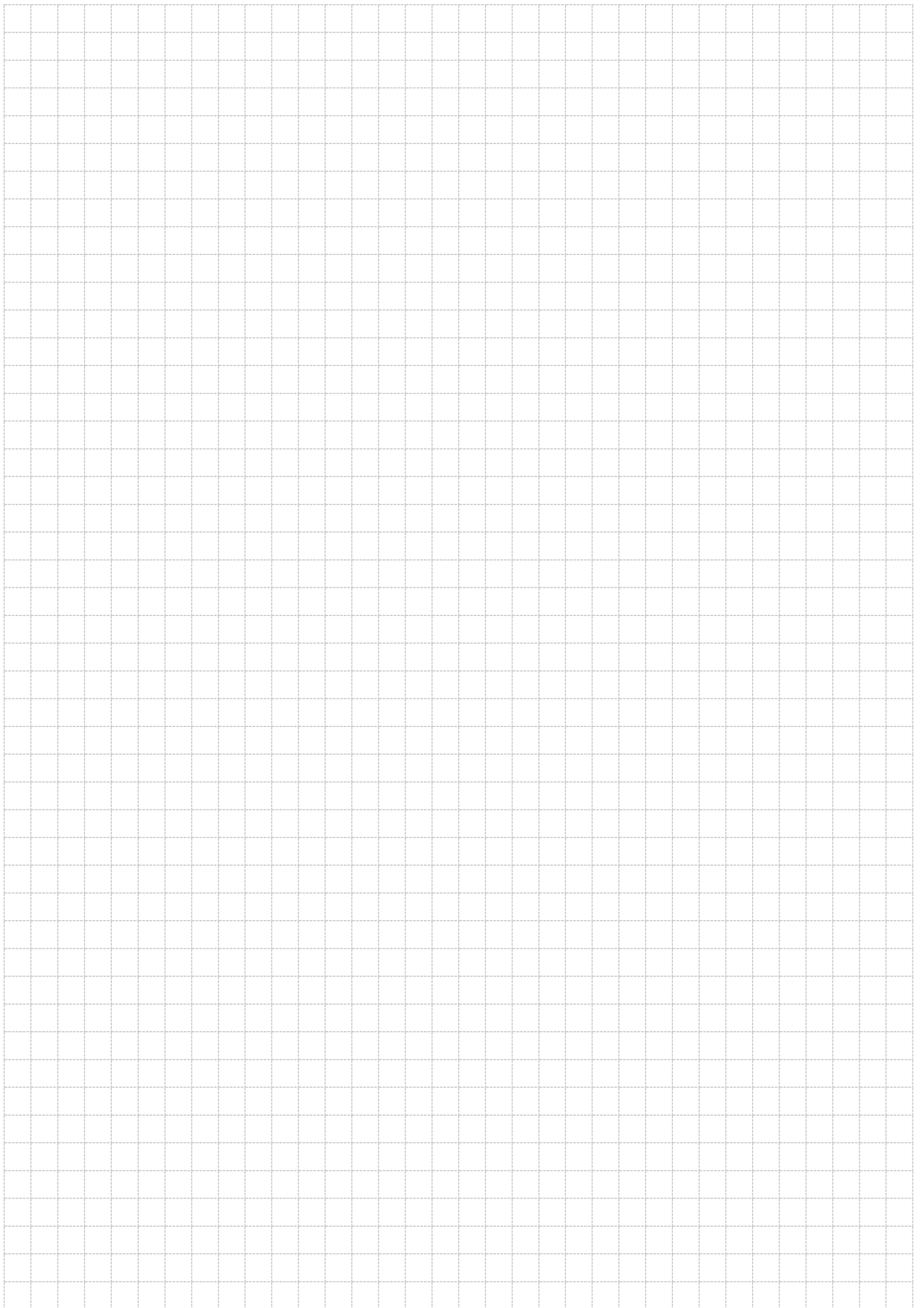

12. Directories

12.1 List of figures

figure 3.1:	Structure	21
figure 4.1:	Set-up and fasten.....	25
figure 4.2:	Assembly alternatives	25
figure 4.3:	Changing the vibration plate	26
figure 5.1:	Connection strip form the control box	27
figure 5.2:	Connection to the VarioShaker	29
figure 6.1:	VarioShaker user interface.....	32
figure 6.2:	Resetting network settings	33
figure 6.3:	PRESET CLIPS	34
figure 6.4:	Preset and file management (RED)	36
figure 6.5:	Preset and file management (RED)	37
figure 6.6:	Basics clip EDITOR-1	38
figure 6.7:	Function buttons-2	39
figure 6.8:	Function buttons-3	40
figure 6.9:	CLIP EDITOR (green) - Other functions.....	41
figure 6.10:	CLIP EDITOR (green) - Introduction to the creation of CLIPS	42
figure 6.11:	SEQUENCE EDITOR (blue) - Basics of the SEQUENCE EDITOR-1	43
figure 6.12:	SEQUENCE EDITOR (blue) - Basics of the SEQUENCE EDITOR-2	44
figure 6.13:	SEQUENCE EDITOR (blue) - Renaming a clip	44
figure 6.14:	SEQUENCE EDITOR (blue) - SLOT assignment	45
figure 6.15:	SEQUENCE EDITOR (blue) - Overwrite SLOT	45
figure 6.16:	Settings (Yellow) - Presettings (Preferences)	46
figure 6.17:	Settings (Yellow) - Network configuration (Network)	47
figure 6.18:	Settings (Yellow) - Data backup and restoration (backup and load)	48
figure 6.19:	Settings (Yellow) - Input and output check (digital IO check)	48
figure 6.20:	Update and Version (Update and Version)	50
figure 7.1:	General measures for service and maintenance	56

12.2 List of tables

table 1.1:	Explanation of used symbols	14
table 2.1:	Safety while working on electrical equipment.....	19
table 5.1:	Connection strip form the control box	28
table 6.1:	PRESET CLIPS	35
table 6.2:	Tips for operation	53
table 10.1:	Technical data.....	61
table 10.2:	Dimensions	61
table 10.3:	Climatic and environmental requirements	61
table 10.4:	Electrical and software-technical requirements.....	62