

# MA4525EUM

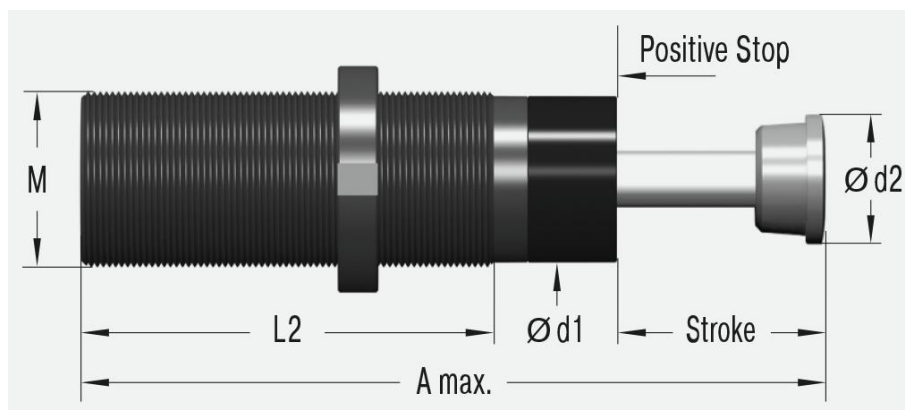

<b>Skok</b>	23.1 mm
<b>A maks.</b>	145 mm
<b>L2</b>	95 mm
<b>M</b>	M45x1.5
<b>d1</b>	42 mm
<b>d2</b>	35 mm

## Parametry techniczne:

<b>Energia na cykl</b>	425 Nm	<b>Czas powrotu</b>	0.03 s
<b>Energia na godzinę</b>	107 000 Nm	<b>Maksymalne obciążenie osiowe</b>	4°
<b>Minimalna masa efektywna</b>	40 kg	<b>Temperatura pracy</b>	-12°C do +66°C
<b>Maksymalna masa efektywna</b>	10 000 kg	<b>Sposób montażu</b>	W dowolnej pozycji
<b>Minimalna siła powrotu</b>	70 N	<b>Medium tłumiące</b>	Olej
<b>Maksymalna siła powrotu</b>	100 N	<b>Masa</b>	1.13 kg

## Dostępne akcesoria:

### Tuleja zderzaka z czujnikiem zbliżeniowym AS45

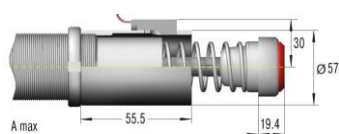

### Adapter uderzeń nie osiowych BV4525

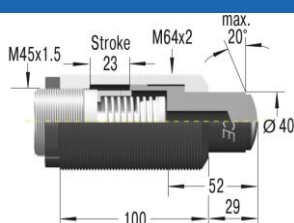

### Adapter uderzeń nie osiowych BV4550

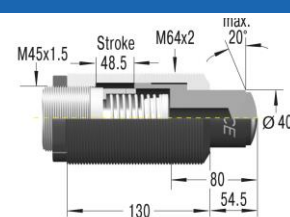

### Nakrętka NM45

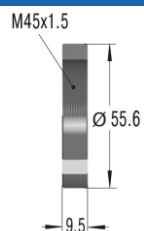

### Kaptur ochronny PB4550

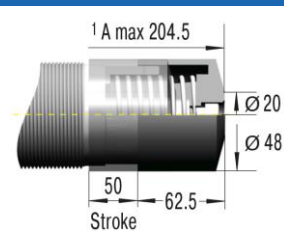

### Kaptur ochronny PB4525

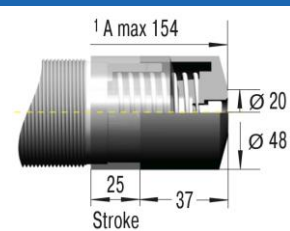

**Głowica nylonowa  
PP45**

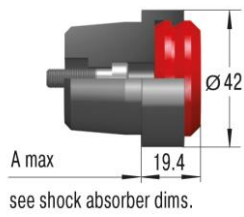

**Zestaw do montażu wahliwego  
C45**

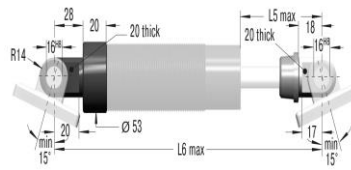

**Zestaw do montażu na łapach  
S45**

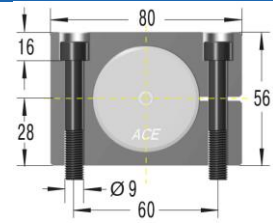

**Kołnierz mocujący  
kwadratowy  
QF45**

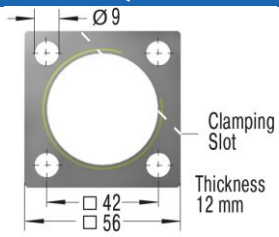

**Mocowanie widelkowe  
SF45**

